

KUKKO // *Pull forward*



PRICELIST 2024





Prices are subject to change at short notice







W11

Valid from 2024-01-01

All previous price lists lose their validity with this list. This price list is based on our general terms and conditions. Dimensions and weights are only approximate. We reserve the right to make changes to models and designs, errors and printing errors. All prices net plus VAT.

Pulling > Universal puller with sliding, always parallel Pulling hooks > 20



20-Classic	Ku-STA	Item number	 min. - max.	 max.		Price
<p>The 2-arm universal puller is used to remove bearings, gears and discs in all standard sizes. It can be used to remove components that sit on shafts and are freely accessible from the outside. The puller all-rounder ensures particularly safe, non-destructive removal.</p> 		20-1	9 mm - 90 mm	100 mm	1	134,40 EUR
		20-10	9 mm - 130 mm	100 mm	1	143,80 EUR
		20-2	10 mm - 160 mm	162 mm	1	268,80 EUR
		20-20	10 mm - 200 mm	162 mm	1	295,60 EUR
		20-3	0 mm - 250 mm	210 mm	1	470,40 EUR
		20-30	0 mm - 350 mm	200 mm	1	512,80 EUR
		20-4	15 mm - 520 mm	209 mm	1	1.075,20 EUR
		20-40	15 mm - 650 mm	300 mm	1	1.827,80 EUR
		20-1-2	0 mm - 90 mm	200 mm	1	189,00 EUR
		20-1-25	0 mm - 90 mm	250 mm	1	205,80 EUR
		20-1-4	0 mm - 90 mm	400 mm	1	309,20 EUR
		20-10-2	0 mm - 120 mm	200 mm	1	198,40 EUR
		20-10-25	0 mm - 120 mm	250 mm	1	215,20 EUR
		20-10-4	0 mm - 120 mm	400 mm	1	251,40 EUR
		20-2-3	3,2 mm - 160 mm	300 mm	1	365,40 EUR
		20-20-3	3,2 mm - 200 mm	300 mm	1	392,20 EUR
		20-3-25	0 mm - 250 mm	250 mm	1	483,00 EUR
		20-3-3	0 mm - 250 mm	300 mm	1	514,00 EUR
		20-3-4	0 mm - 250 mm	400 mm	1	555,60 EUR
		20-3-5	0 mm - 250 mm	500 mm	1	577,80 EUR
		20-30-3	0 mm - 350 mm	300 mm	1	556,20 EUR
		20-30-4	0 mm - 350 mm	400 mm	1	556,20 EUR
		20-30-5	0 mm - 350 mm	500 mm	1	620,00 EUR
		20-4-3	15 mm - 520 mm	300 mm	1	1.118,80 EUR
		20-4-4	15 mm - 520 mm	400 mm	1	1.160,40 EUR
		20-4-5	15 mm - 520 mm	500 mm	1	1.182,60 EUR
	20-40-4	15 mm - 650 mm	400 mm	1	1.913,20 EUR	
	20-40-5	15 mm - 650 mm	500 mm	1	1.935,20 EUR	

20-Classic	Ku-STA	Item number	 min. - max.	 max.	 1	Price
		20-5	0 mm - 750 mm	400 mm	1	4.021,20 EUR
24	Ku-STA	Item number			 1	Price
<p>The Series 24 ball bearing puller and extractor sets are used for extracting bearings, gears, discs and internal bearings, bearing outer rings and bushes during repairs and maintenance. The set includes internal extractors, counter stays, extractor chucks and external extractors.</p>		24-A	20-1, 43-1, 22-1, 22-2, 21-1, 21-2, 21-3, 21-4, 21-5, 21-6, 23	17,5 kg	1	1.613,80 EUR
		24-B	20-1, 20-2, 22-1, 22-2, 21-1, 21-2, 21-3, 21-4, 21-5, 21-6, 21-7, 21-8, 23, 43-1	18 kg	1	2.360,00 EUR
		24-C	20-1, 20-2, 43-1, 22-1, 22-2, 22-4, 21-1, 21-2, 21-3, 21-4, 21-5, 21-6, 21-7, 21-8, 21-89, 23	23,98 kg	1	3.077,40 EUR

20-Classic-B
Ku-STA

The 2-arm universal puller with adjustable pulling hooks and grease-hydraulic spindle is used for the particularly safe removal of extremely tight bearings, gears and discs. It can be used to remove any component that sits on a shaft and is freely accessible from the outside.





















Item number	 min. - max.	 max.		Price
20-2-B	11 mm - 160 mm	150 mm	1	655,20 EUR
20-20-B	11 mm - 200 mm	160 mm	1	682,00 EUR
20-3-B	0 mm - 250 mm	200 mm	1	915,60 EUR
20-30-B	0 mm - 350 mm	200 mm	1	958,00 EUR
20-4-B	5,4 mm - 520 mm	200 mm	1	1.968,40 EUR
20-40-B	5,4 mm - 650 mm	300 mm	1	2.721,00 EUR
20-2-3-B	3,2 mm - 160 mm	300 mm	1	751,80 EUR
20-20-3-B	3,2 mm - 200 mm	300 mm	1	778,60 EUR
20-3-3-B	0 mm - 250 mm	300 mm	1	959,20 EUR
20-3-4-B	0 mm - 250 mm	400 mm	1	1.000,80 EUR
20-3-5-B	0 mm - 250 mm	500 mm	1	1.023,00 EUR
20-30-3-B	0 mm - 350 mm	300 mm	1	1.001,40 EUR
20-30-4-B	0 mm - 350 mm	400 mm	1	1.001,40 EUR
20-30-5-B	0 mm - 350 mm	500 mm	1	1.065,20 EUR
20-4-3-B	15 mm - 520 mm	300 mm	1	2.012,00 EUR
20-4-4-B	15 mm - 520 mm	400 mm	1	2.053,80 EUR
20-4-5-B	15 mm - 520 mm	500 mm	1	2.075,80 EUR
20-40-4-B	15 mm - 650 mm	400 mm	1	2.806,40 EUR
20-40-5-B	15 mm - 650 mm	500 mm	1	2.828,40 EUR





















K-2030-20-B
Ku-STA





















The hydraulic 2- and 3-arm universal puller kit of the 2030 series is used for hydraulically pulling off large bearings, gears, pulleys, etc. The kit in a strong design for commercial vehicles allows the assembly of 14 different puller models.























Item number				Price
K-2030-20-B	621220, 621355, 600-17, 8-0-621, 2-150-S, 2-300-S, 2-V-150-S, 30-20-T, 2-150-E	15,94 kg	1	1.551,00 EUR





20-S	Ku-STA	Item number	 min. - max.	 max.		Price
<p>The 2-jaw universal puller with narrow pulling hooks is used to safely remove bearings, gears and discs. It can be used to remove components that are mounted on shafts and are freely accessible from the outside. The narrow pulling hooks ensure that narrow spaces can be reached.</p>		20-1-S	11 mm - 90 mm	100 mm	1	161,20 EUR
		20-10-S	4 mm - 120 mm	100 mm	1	187,00 EUR
		20-2-S	16 mm - 160 mm	150 mm	1	322,60 EUR
		20-20-S	16 mm - 200 mm	150 mm	1	354,80 EUR
		20-3-S	21 mm - 250 mm	200 mm	1	645,20 EUR
		20-30-S	21 mm - 350 mm	200 mm	1	709,80 EUR
<p>K-2030-10-S</p> <p>The 2- and 3-arm universal puller kit with narrow pullers of the 2030 series is used for pulling off bearings, gears, washers etc. for narrow and poorly accessible gaps. The kit allows the assembly of 8 different puller models.</p>	<p>Ku-STA</p> 	<p>Item number</p> <p>K-2030-10-S</p>	 min. - max.	 max.		<p>Price</p> <p>1.012,20 EUR</p>
<p>20+</p> <p>The 2-arm universal puller is used to remove bearings, gears and discs. It can be used to remove any component that sits on a shaft and is freely accessible from the outside. The all-rounder puller ensures safe removal on external removal and internal extraction.</p>	<p>Ku-STA</p> 	<p>Item number</p>	 min. - max.	 max.		<p>Price</p>
		20-1+	9 mm - 90 mm	100 mm	1	161,20 EUR
		20-10+	10 mm - 130 mm	100 mm	1	172,60 EUR
		20-10+2	10 mm - 130 mm	200 mm	1	332,60 EUR
		20-2+	10 mm - 160 mm	162 mm	1	308,00 EUR
		20-2+3	10 mm - 160 mm	300 mm	1	411,60 EUR
		20-20+	10 mm - 200 mm	162 mm	1	347,00 EUR
		20-3+	0 mm - 250 mm	210 mm	1	553,60 EUR
		20-30+	0 mm - 350 mm	200 mm	1	572,40 EUR
<p>K-2030-1+A</p> <p>The 2- and 3-arm universal puller set with narrow, quick-adjustable puller hooks of the 2030 series is used for pulling off bearings, gears, washers etc. for narrow and poorly accessible gaps. The series convinces with its versatile design possibilities.</p>	<p>Ku-STA</p> 	<p>Item number</p> <p>K-2030-1+A</p>	 min. - max.	 max.		<p>Price</p> <p>576,80 EUR</p>

20+B	Ku-STA	Item number	 min. - max.	 max.		Price	
<p>The 2-jaw universal puller with quick adjustable pulling hooks and grease-hydraulic spindle is used for the particularly safe and user-friendly removal of extremely tight bearings, gears and discs. It can be used to loosen components that are freely accessible from the outside.</p> 	Ku-STA	20-2+B	11 mm - 160 mm	150 mm	1	694,40 EUR	
		20-20+B	11 mm - 200 mm	160 mm	1	733,40 EUR	
		20-3+B	0 mm - 250 mm	200 mm	1	998,80 EUR	
		20-30+B	0 mm - 350 mm	200 mm	1	1.017,60 EUR	
K-20-1-2+B	Ku-STA	Item number				Price	
<p>The 2-arm universal puller in the kit with quick adjustment, hydraulic spindle and extensions is used for pulling off normal and particularly tight bearings, gears, washers, etc. The "6 in 1" kit allows the assembly of 6 different puller models</p> 	Ku-STA	K-20-1-2+B		0 kg	1	0,00	
20+S	Ku-STA	Item number	 min. - max.	 max.		Price	
<p>The 2-jaw universal puller with quick adjustable pulling hooks is used for the safe and user-friendly removal of bearings, gears and discs in all common sizes. It can be used to remove components that sit on shafts and are freely accessible from the outside.</p> 	Ku-STA	20-1+S	4 mm - 90 mm	100 mm	1	174,80 EUR	
		20-10+S	4 mm - 120 mm	100 mm	1	215,60 EUR	
		20-2+S	16 mm - 160 mm	150 mm	1	374,40 EUR	
		20-20+S	16 mm - 200 mm	150 mm	1	362,00 EUR	
		20-3+S	21 mm - 250 mm	200 mm	1	612,20 EUR	
		20-30+S	21 mm - 350 mm	200 mm	1	632,00 EUR	
K-2030-1+A	Ku-STA	Item number				Price	
<p>The 2- and 3-arm universal puller set with narrow, quick-adjustable puller hooks of the 2030 series is used for pulling off bearings, gears, washers etc. for narrow and poorly accessible gaps. The series convinces with its versatile design possibilities.</p> 	Ku-STA	K-2030-1+A		600-17, 1-V-100-S, 1-90-S, 20-1-T	4,755 kg	1	576,80 EUR
20-S-T	Ku-STA	Item number	 min. - max.	 max.		Price	
<p>The 2-jaw universal puller with extremely narrow pulling hooks and trapezoidal contact surface on the claw is used to safely pull off gearwheels, bearings, pinions, synchroniser bodies and similar components. It can be used to remove components that are freely accessible from the outside.</p> 	Ku-STA	20-1-S-T	16 mm - 90 mm	100 mm	1	161,20 EUR	
		20-10-S-T	16 mm - 120 mm	100 mm	1	187,00 EUR	





K-2030-10-S-T	Ku-STA	Item number				Price
<p>The 2- and 3-arm universal puller kit with extremely narrow pullers is used for pulling off gearwheels, bearings, pinions, synchroniser bodies etc. for extremely narrow and poorly accessible gaps. The kit allows the assembly of 8 different puller models.</p>		K-2030-10-S-T	20-10-SP-T, 614250, 1-194-E	8,805 kg	1	1.012,20 EUR
<p>The 2-jaw universal puller with extremely narrow pulling hooks with quick adjustable pulling hooks and trapezoidal contact surface on the claw is used for the safe and user-friendly pulling of transmission gears, bearings, pinions, synchroniser bodies and similar components.</p>		20-1+S-T 20-10+S-T	 min. - max. 16 mm - 90 mm 16 mm - 120 mm	 max. 100 mm 100 mm	 1 1	Price 201,60 EUR 215,60 EUR
<p>The 2-arm universal puller in a set with extensions is used for universal use when pulling off gearwheels, bearings, pinions and synchroniser bodies in all common sizes. It can be used to loosen any component that sits on a shaft and is freely accessible from the outside.</p>		K-20-1+S-T	20-1+S, 1-95-P, 1-V-100-P, 699915	 2,64 kg	 1	 Price 281,40 EUR
<p>The 2-arm universal puller with adjustable pulling hooks is used for the particularly safe removal of bearings, gears and discs in all common sizes for trades, workshops and industry. It can be used to loosen parts that sit on shafts and are freely accessible from the outside.</p>		20-10-P3 20-20-P2 20-30-P3	 min. - max. 9 mm - 130 mm 10 mm - 200 mm 0 mm - 350 mm	 max. 100 mm 162 mm 200 mm	 1 1 1	Price 404,20 EUR 514,00 EUR 1.166,40 EUR
<p>The 2- and 3-arm universal puller kit of the 2030 series is used to pull off bearings, gears, washers, etc. The kit allows the assembly of 8 different puller models by combining pullers and extensions.</p>		K-2030-10	20-10-P3, 614250, 1-190-E	 9,19 kg	 1	 Price 889,40 EUR





20-SP	Ku-STA	Item number				Price
<p>The 2-jaw universal puller with narrow pulling hooks is used to safely remove bearings, gears and discs in all common sizes. It can be used to remove any component that sits on a shaft and is freely accessible from the outside.</p> 		20-10-SP	11 mm - 120 mm	100 mm	1	489,00 EUR
		20-20-SP	26 mm - 200 mm	150 mm	1	797,20 EUR
		20-30-SP	21 mm - 350 mm	200 mm	1	1.463,20 EUR
K-2030-10-S	Ku-STA	Item number				Price
<p>The 2- and 3-arm universal puller kit with narrow pullers of the 2030 series is used for pulling off bearings, gears, washers etc. for narrow and poorly accessible gaps. The kit allows the assembly of 8 different puller models.</p> 		K-2030-10-S	20-10-SP, 30-10-SP, 614250	8,92 kg	1	1.012,20 EUR
20-SP-T	Ku-STA	Item number				Price
<p>The 2-jaw universal puller with extremely narrow pulling hooks and trapezoidal contact surface on the claw is used to safely pull off gear wheels, bearings, pinions, synchroniser bodies and similar components. It can be used to loosen parts that are freely accessible from the outside.</p> 		20-10-SP-T	16 mm - 120 mm	100 mm	1	489,00 EUR
K-2030-10-S-T	Ku-STA	Item number				Price
<p>The 2- and 3-arm universal puller kit with extremely narrow pullers is used for pulling off gearwheels, bearings, pinions, synchroniser bodies etc. for extremely narrow and poorly accessible gaps. The kit allows the assembly of 8 different puller models.</p> 		K-2030-10-S-T	20-10-SP-T, 614250, 1-194-E	8,805 kg	1	1.012,20 EUR





20+SP	Ku-STA	Item number	 min. - max.	 max.		Price
<p>The 2-jaw universal puller with quick adjustable pulling hooks is used for the safe and user-friendly removal of bearings, gears and discs in all common sizes. It can be used to remove components that sit on shafts and are freely accessible from the outside.</p> 		20-10+SP	16 mm - 120 mm	100 mm	1	517,40 EUR
		20-20+SP	16 mm - 200 mm	150 mm	1	713,00 EUR
		20-30+SP	21 mm - 350 mm	200 mm	1	1.603,40 EUR

K-2030-10+S	Ku-STA	Item number				Price
<p>The 2- and 3-arm universal puller kit with narrow, quick-adjustable pullers is used for pulling off bearings, gears, washers etc. for narrow and poorly accessible gaps. The kit allows the assembly of 8 different puller models.</p> 		K-2030-10+S	20-10+S, 614250, 1-193-S, 1-253-S	8,5 kg	1	979,80 EUR

Pulling > External > Puller for VW-AUDI clutch





20-V	Ku-STA	Item number	 min. - max.	 max.		Price
<p>The 2-arm puller for transmission gears is used to pull off transmission gears for the VW/Audi clutch/ transmission combination from year of manufacture 2007. With strong, slim special hooks and subsequently fixable side clamp, the 20-V series is an ideal problem solver.</p> 		20-10-V	0 mm - 120 mm	100 mm	1	431,40 EUR

20-AV	Ku-STA	Item number	 min. - max.	 max.		Price
<p>The 2-arm universal puller with adjustable clamping depth is used to pull bearings, gears and discs in all common sizes. The 20-5 is the most powerful puller in the 20 series. It can be used to remove parts that sit on shafts and are freely accessible from the outside.</p> 		20-4-AV	0 mm - 520 mm	300 mm	1	1.442,20 EUR
		20-40-AV	0 mm - 650 mm	300 mm	1	2.004,20 EUR
		20-5-AV	0 mm - 750 mm	400 mm	1	4.024,00 EUR





20-H	Ku-STA	Item number	 min. - max.	 max.		Price
<p>The 2-arm universal puller with hydraulic spindle is used to remove bearings, gears and discs in all standard sizes. Thanks to the integrated grease hydraulics, no external pump is required. Depending on the thread size, the flexible connection thread on the spindle allows the mounting of numerous puller tools from the KUKKO range.</p> 		20-3-H NEW	0 mm - 250 mm	210 mm	1	1.057,28 EUR
		20-30-H NEW	0 mm - 350 mm	210 mm	1	1.924,00 EUR
		20-4-H NEW	15 mm - 520 mm	209 mm	1	2.604,00 EUR
		20-40-H NEW	15 mm - 650 mm	300 mm	1	3.355,80 EUR
		20-5-H	105 mm - 750 mm	400 mm	1	4.602,22 EUR

Storage / Presentation > Storage / Presentation > Sales displays

20-ST	Ku-STA	Item number				Price
<p>The Sales display for 2-jaw universal pullers is the ideal solution for presenting and storing different sized 2-jaw universal pullers. The 2-arm universal pullers are used to pull bearings, gears and discs in all common sizes.</p>		20-ST	20-1, 20-10, 20-2, 20-20, 20-3, 20-STL	20,16 kg	1	1.236,80 EUR
<p>The sales display for 2-arm universal pullers is the ideal solution for the presentation and storage of different sized 2-arm universal pullers. The 2-arm universal pullers with narrow puller hooks are used to safely pull off bearings, gears and pulleys.</p>		20-ST-S	20-1-S, 20-10-S, 20-2-S, 20-20-S, 20-3-S, 20-STL	19,67 kg	1	1.597,00 EUR
<p>The Sales display for 2-jaw universal pullers is the ideal solution for presenting and storing different sized 2-jaw universal pullers. The 2-arm universal pullers are used to pull bearings, gears and discs in all common sizes.</p>		20-ST+	20-STL, 20-1+, 20-10+, 20-2+, 20-20+, 20-3+	20,2 kg	1	1.423,00 EUR
<p>The sales display for 2-arm universal pullers is the ideal solution for the presentation and storage of different sized 2-arm universal pullers. The 2-arm universal pullers with narrow, quickly adjustable puller hooks are used for the safe and user-friendly pulling off of bearings, gears and washers in all common sizes.</p>		20-ST+S	20-1+S, 20-10+S, 20-2+S, 20-20+S, 20-3+S, 20-STL	19,87 kg	1	1.620,20 EUR





20+ST+S	Ku-STA	Item number				Price
<p>The sales display for 2-arm universal pullers is the ideal solution for the presentation and storage of different sized 2-arm universal pullers. The 2-arm universal pullers with narrow, quickly adjustable puller hooks are used for the safe and user-friendly pulling off of bearings, gears and washers in all common sizes.</p>		20+ST+S	20-1+, 20-10+S, 20-2+S, 20-10+2, 20-2+3, 20-STL	16,27 kg	1	1.324,20 EUR

Spare parts > Spare parts > Various



20-STL	KU-STA	Item number				Price
<p>The sales display for universal pullers is the ideal solution for the presentation and storage of various sized universal pullers. This version is not equipped and can be fitted with any pullers.</p>		20-STL	120-ST, 20-ST, 20-ST-S, 20-ST+	1 kg	1	160,00 EUR





Spare parts > Spare parts > Traverse





20-T KU-STA	Item number	 KOMBINIERBAR COMBINABLE			Price
<p>The crossbars are spare parts for 2-arm universal pullers of the 20 series. The pullers are continuously adjustable on the crossbar.</p> 	20-1-T	20-10+2, 20-1-S, 20-1, 20-10+, 20-1+, 20-1-S-T, 20-1+C, 20-1+S, 20-1-2, 20-1-25, 20-1-4, K-20-15, 20-1+S-T, 20-1+S-T-C	0,435 kg	1	60,00 EUR
	20-10-T	20-10+2, 20-10-P3, 20-10-S, 20-10, K-2030-10-S, 20-10-SP, 20-10-S-T, 20-10+, 20-10-SP-T, 20-10+C, 20-10+S, 20-10+SP, 20-10-2, 20-10-25, 20-10-4, K-2030-10, 20-10+S-T, 20-10+S-T-C, 20-10-V	0,58 kg	1	80,00 EUR
	20-2-T	20-2-3-B, 20-2+3, 20-2-S, 20-2, 20-2+, 20-2+C, 20-2+B, 20-2+S, K-20-15, 20-2-3, 20-2-B	1 kg	1	120,00 EUR







20-T	KU-STA	Item number	 		Price	
		20-20-T	20-20-3-B, 20-20-P2, 20-20-S, 20-20, 20-20-SP, 20-20+, 20-20+C, 20-20+B, 20-20+S, 20-20+SP, 20-20-3, 20-20-B	1,28 kg	1	168,00 EUR
		20-3-T	20-3-5, 20-3-B, 20-3-3-B, 20-3-4-B, 20-3-5-B, 20-3-S, 20-3, 20-3+, 20-3+C, 20-3+B, 20-3+S, 20-3-25, 20-3-3, 20-3-4	2,62 kg	1	320,00 EUR
		20-30-T	20-30-3, 20-30-B, 20-30-4, 20-30-5, 20-30-3-B, 20-30-4-B, 20-30-5-B, 20-30-P3, 20-30-S, 20-30, 20-30-SP, 20-30+, 20-30+B, 20-30+SP, 20-30+S	3,135 kg	1	256,90 EUR
		20-4-T	20-4-B, 20-4-3, 20-4-4, 20-4-5, 20-4-AV, 20-4-3-B, 20-4-4-B, 20-4-5-B, 20-4, 20-4-H, 20-5-H	8,64 kg	1	520,00 EUR
		20-40-T	20-40-B, 20-40-4, 20-40-5, 20-40-AV, 20-40-4-B, 20-40-5-B, 20-40, 20-40-H	10,2 kg	1	1.000,00 EUR

20-T	KU-STA	Item number				Price
		20-5-T	20-40-H, 20-5, 20-5- AV	18,92 kg	1	1.665,44 EUR







Optional extensions > Accessories > Clamping clamp













219	KU-STA	Item number				Price
<p>The clamp for 2-arm pullers is used to support stability during pull-off operations with extensions. This presses the puller hooks particularly firmly against the part to be pulled off</p> 		219-1	40 mm - 190 mm	20-1, 20-10	1	103,40 EUR















Spare parts > Spare parts > Clamping clamp





















219-V	KU-STA	Item number				Price
<p>The clamp is a spare part for 2-arm pullers for gearwheels for VW/Audi clutch-gearbox combination of the 20-V series. The clamp increases the contact pressure of the puller hooks many times over.</p> 		219-V	20-10-V	0,285 kg	1	120,00 EUR





















Pulling > Universal puller with sliding, always parallel Pulling hooks > 30

30-Classic	Ku-STA	Item number	 min. - max.	 max.		Price
<p>The 3-arm universal puller is used to remove bearings, gears and discs in all common sizes. Equipped with robust and adjustable standard hooks, the puller all-rounder ensures particularly safe, non-destructive removal of parts mounted on shafts.</p>		30-1	0 mm - 90 mm	100 mm	1	188,20 EUR
		30-10	0 mm - 130 mm	100 mm	1	207,00 EUR
		30-2	0 mm - 160 mm	150 mm	1	376,40 EUR
		30-20	0 mm - 200 mm	150 mm	1	414,20 EUR
		30-3	0 mm - 250 mm	200 mm	1	752,60 EUR
		30-30	105 mm - 375 mm	200 mm	1	918,20 EUR
		30-4	105 mm - 375 mm	200 mm	1	1.505,20 EUR
		30-40	125 mm - 520 mm	200 mm	1	1.806,40 EUR
		30-5	87 mm - 650 mm	300 mm	1	2.634,20 EUR
		30-1-2	0 mm - 90 mm	200 mm	1	259,60 EUR
		30-10-2	0 mm - 130 mm	200 mm	1	285,60 EUR
		30-2-3	5 mm - 160 mm	300 mm	1	511,60 EUR
		30-20-3	5 mm - 200 mm	300 mm	1	549,20 EUR
		30-3-25	0 mm - 250 mm	250 mm	1	765,20 EUR
		30-3-3	0 mm - 250 mm	300 mm	1	796,20 EUR
		30-3-4	0 mm - 250 mm	400 mm	1	838,00 EUR
		30-3-5	0 mm - 250 mm	500 mm	1	860,00 EUR
		K-2030-10	Ku-STA	Item number		
<p>The 2- and 3-arm universal puller kit of the 2030 series is used to pull off bearings, gears, washers, etc. The kit allows the assembly of 8 different puller models by combining pullers and extensions.</p>		K-2030-10	20-10-P3, 614250, 1-190-E	9,19 kg	1	889,40 EUR





30-Classic-B	Ku-STA	Item number	 min. - max.	 max.	 Price
<p>The 2-arm universal puller with adjustable pulling hooks and grease-hydraulic spindle is used for the particularly safe removal of extremely tight bearings, gears and discs. It can be used to remove any component that sits on a shaft and is freely accessible from the outside.</p> 		30-2-B	0 mm - 160 mm	150 mm	1 762,80 EUR
		30-20-B	0 mm - 200 mm	150 mm	1 800,60 EUR
		30-3-B	0 mm - 250 mm	200 mm	1 1.331,40 EUR
		30-30-B	0 mm - 375 mm	200 mm	1 1.811,40 EUR
		30-2-3-B	5 mm - 160 mm	300 mm	1 762,80 EUR
		30-20-3-B	5 mm - 200 mm	300 mm	1 935,60 EUR
		30-3-3-B	0 mm - 250 mm	300 mm	1 1.241,40 EUR
		30-3-4-B	0 mm - 250 mm	400 mm	1 1.283,20 EUR
		30-3-5-B	0 mm - 250 mm	500 mm	1 1.305,20 EUR
<p>K-2030-20-B</p> <p>The hydraulic 2- and 3-arm universal puller kit of the 2030 series is used for hydraulically pulling off large bearings, gears, pulleys, etc. The kit in a strong design for commercial vehicles allows the assembly of 14 different puller models.</p> 	Ku-STA	Item number			 Price
		K-2030-20-B	621220, 621355, 600-17, 8-0-621, 2-150-S, 2-300-S, 2-V-150-S, 30-20-T, 2-150-E	15,94 kg	1 1.551,00 EUR
<p>30-P</p> <p>The 3-arm universal puller with adjustable pulling hooks is used for the particularly safe removal of bearings, gears and discs in all common sizes. It can be used to remove any component that sits on a shaft and is freely accessible from the outside.</p> 	Ku-STA	Item number	 min. - max.	 max.	 Price
		30-10-P3	0 mm - 130 mm	100 mm	1 628,00 EUR
		30-20-P2	5 mm - 200 mm	150 mm	1 763,60 EUR
		30-3-P3	0 mm - 250 mm	200 mm	1 1.828,20 EUR

K-2030-10	Ku-STA	Item number				Price
<p>The 2- and 3-arm universal puller kit of the 2030 series is used to pull off bearings, gears, washers, etc. The kit allows the assembly of 8 different puller models by combining pullers and extensions.</p>		K-2030-10	20-10-P3, 614250, 1-190-E	9,19 kg	1	889,40 EUR
30-S	Ku-STA	Item number	 min. - max.	 max.		Price
<p>The 3-arm universal puller with narrow pulling hooks is used to safely remove bearings, gears and discs. It can be used to remove any component that sits on a shaft and is freely accessible from the outside. The narrow hooks ensure that narrow gaps can be reached.</p>		30-1-S	8 mm - 90 mm	100 mm	1	244,40 EUR
		30-10-S	8 mm - 130 mm	100 mm	1	250,40 EUR
		30-2-S	16 mm - 160 mm	150 mm	1	488,80 EUR
		30-20-S	16 mm - 200 mm	150 mm	1	488,80 EUR
		30-3-S	2 mm - 250 mm	200 mm	1	880,00 EUR
K-2030-10-S	Ku-STA	Item number				Price
<p>The 2- and 3-arm universal puller kit with narrow pullers of the 2030 series is used for pulling off bearings, gears, washers etc. for narrow and poorly accessible gaps. The kit allows the assembly of 8 different puller models.</p>		K-2030-10-S	20-10-SP, 30-10-SP, 614250	8,92 kg	1	1.012,20 EUR
30-SP	Ku-STA	Item number	 min. - max.	 max.		Price
<p>The 3-arm universal puller with narrow, adjustable pulling hooks is used to safely pull bearings, gears and discs. Three pairs of Pulling hooks (pair) enable universal application. It can be used to remove components that are mounted on shafts and are freely accessible from the outside.</p>		30-10-SP	8 mm - 130 mm	100 mm	1	751,00 EUR
		30-20-SP	11 mm - 200 mm	150 mm	1	997,60 EUR
		30-3-SP	2 mm - 250 mm	200 mm	1	2.122,20 EUR
K-2030-10-S	Ku-STA	Item number				Price
<p>The 2- and 3-arm universal puller kit with narrow pullers of the 2030 series is used for pulling off bearings, gears, washers etc. for narrow and poorly accessible gaps. The kit allows the assembly of 8 different puller models.</p>		K-2030-10-S	20-10-SP, 30-10-SP, 614250	8,92 kg	1	1.012,20 EUR





30-S-T	Ku-STA	Item number				Price
<p>The 3-arm universal puller with extremely narrow pulling hooks and trapezoidal contact surface on the claw is used to safely pull off transmission gears, bearings, pinions, synchroniser bodies and similar components. It can be used to remove components that are freely accessible from the outside.</p> 		30-1-S-T	13 mm - 90 mm	100 mm	1	244,40 EUR
		30-10-S-T	13 mm - 130 mm	100 mm	1	250,40 EUR
K-2030-10-S-T	Ku-STA	Item number				Price
<p>The 2- and 3-arm universal puller kit with extremely narrow pullers is used for pulling off gearwheels, bearings, pinions, synchroniser bodies etc. for extremely narrow and poorly accessible gaps. The kit allows the assembly of 8 different puller models.</p> 		K-2030-10-S-T	20-10-SP-T, 614250, 1-194-E	8,805 kg	1	1.012,20 EUR
30+	Ku-STA	Item number				Price
<p>The 3-arm universal puller with quick-adjustable pulling hooks is used to pull bearings, gears and discs in all common sizes. It can be used to remove any component that sits on a shaft and is freely accessible from the outside.</p> 		30-1+	0 mm - 90 mm	100 mm	1	197,60 EUR
		30-10+	0 mm - 130 mm	100 mm	1	227,60 EUR
		30-2+	0 mm - 160 mm	150 mm	1	397,40 EUR
		30-20+	0 mm - 200 mm	150 mm	1	421,20 EUR
		30-3+	0 mm - 250 mm	200 mm	1	812,20 EUR
		30-30+	105 mm - 375 mm	200 mm	1	964,00 EUR
K-2030-1+A	Ku-STA	Item number				Price
<p>The 2- and 3-arm universal puller set with narrow, quick-adjustable puller hooks of the 2030 series is used for pulling off bearings, gears, washers etc. for narrow and poorly accessible gaps. The series convinces with its versatile design possibilities.</p> 		K-2030-1+A	600-17, 1-V-100-S, 1-90-S, 20-1-T	4,755 kg	1	576,80 EUR
30+B	Ku-STA	Item number				Price
<p>The 3-arm universal puller with quick-adjustable pulling hooks and grease-hydraulic spindle is used for the particularly safe and user-friendly removal of extremely tight bearings, gears and discs. It can be used to loosen components that are freely accessible from the outside.</p> 		30-2+B	0 mm - 160 mm	150 mm	1	783,80 EUR
		30-20+B	0 mm - 200 mm	150 mm	1	800,60 EUR
		30-3+B	0 mm - 250 mm	200 mm	1	1.257,40 EUR
		30-30+B	0 mm - 375 mm	200 mm	1	1.857,20 EUR

30+S	Ku-STA	Item number	 min. - max.	 max.		Price
<p>The 3-arm universal puller with narrow, quickly adjustable pulling hooks is used for the safe and user-friendly removal of bearings, gears and discs in all common sizes. It can be used to remove components that sit on shafts and are freely accessible from the outside.</p> 	Ku-STA	30-1+S	8 mm - 90 mm	100 mm	1	282,20 EUR
		30-10+S	8 mm - 130 mm	100 mm	1	310,40 EUR
		30-2+S	16 mm - 160 mm	150 mm	1	463,60 EUR
		30-20+S	16 mm - 200 mm	150 mm	1	513,60 EUR
		30-3+S	2 mm - 250 mm	200 mm	1	949,60 EUR
K-2030-1+A	Ku-STA	Item number				Price
<p>The 2- and 3-arm universal puller set with narrow, quick-adjustable puller hooks of the 2030 series is used for pulling off bearings, gears, washers etc. for narrow and poorly accessible gaps. The series convinces with its versatile design possibilities.</p> 	Ku-STA	K-2030-1+A	600-17, 1-V-100-S, 1-90-S, 20-1-T	4,755 kg	1	576,80 EUR
30+S-T	Ku-STA	Item number	 min. - max.	 max.		Price
<p>The 3-arm universal puller with extremely narrow, quickly adjustable pulling hooks and trapezoidal contact surface on the claw is used for the safe and user-friendly removal of transmission gears, bearings, pinions, synchroniser bodies and similar components.</p> 	Ku-STA	30-1+S-T	13 mm - 90 mm	100 mm	1	282,20 EUR
		30-10+S-T	13 mm - 130 mm	100 mm	1	310,40 EUR
K-2030-10+S+T	Ku-STA	Item number				Price
<p>The 2- and 3-arm universal puller kit of the 2030 series is used to pull off bearings, gears, washers etc. for narrow and poorly accessible gaps. The kit allows the assembly of 24 different puller models.</p> 	Ku-STA	K-2030-10+S+T	614250, 1-93-S, 1-192-S, 1-255-S	9 kg	1	1.016,40 EUR
30-SP-T	Ku-STA	Item number	 min. - max.	 max.		Price
<p>The 3-arm universal puller with extremely narrow, adjustable pulling hooks and trapezoidal contact surface on the claw is used to safely pull off transmission gears, bearings, pinions, synchroniser bodies and similar components. It can be used to loosen parts that are freely accessible from the outside.</p> 	Ku-STA	30-10-SP-T	13 mm - 130 mm	100 mm	1	751,00 EUR



K-2030-10-S-T	Ku-STA	Item number				Price
<p>The 2- and 3-arm universal puller kit with extremely narrow pullers is used for pulling off gearwheels, bearings, pinions, synchroniser bodies etc. for extremely narrow and poorly accessible gaps. The kit allows the assembly of 8 different puller models.</p>		K-2030-10-S-T	20-10-SP-T, 614250, 1-194-E	8,805 kg	1	1.012,20 EUR



30-T KU-STA	Item number				Price
<p>The crossbars are spare parts for 3-arm universal pullers of the 30 series. The pullers are continuously adjustable on the crossbar.</p> 	30-1-T	30-1+C, 30-1+, 30-1-2, 30-1, 30-1+S, 30-1-S-T, 30-1-S, 30-1+S-T	0,36 kg	1	80,00 EUR
	30-10-T	30-10+S-T, 30-10+C, 30-10-SP, 30-10+, K-2030-10-S, 30-10-2, 30-10, 30-10-SP-T, 30-10-P3, 30-10+S, 30-10-S-T, K-2030-10, 30-10-S	0,515 kg	1	120,00 EUR
	30-2-T	30-2-S, 30-2-3-B, 30-2-B, 30-2+C, 30-2+, 30-2-3, 30-2, 30-2+S, 30-2+B	1 kg	1	200,00 EUR
	30-20-T3	30-20-S, 30-20-3-B, 30-20-B, 30-20-SP, 30-20+C, 30-20+, 30-20-3, 30-20-P2, 30-20, 30-20+S, 30-20+B	1,68 kg	1	200,00 EUR
	30-3-T	30-3-S, 30-3-3-B, 30-3-B, 30-3-4-B, 30-3-SP, 30-3-5-B, 30-3+C, 30-3+, 30-3-25, 30-3-P3, 30-3, 30-3-3, 30-3-4, 30-3+S, 30-3+B, 30-3-5	0,535 kg	1	336,00 EUR

30-T	KU-STA	Item number				Price
		30-30-T	30-30, 30-30-B, 30-30+, 30-30+B	4,645 kg	1	520,00 EUR

Storage / Presentation > Suitcase > K-Outside

K-20-1+S-T	Ku-STA	Item number				Price
<p>The 2-arm universal puller in a set with extensions is used for universal use when pulling off gearwheels, bearings, pinions and synchroniser bodies in all common sizes. It can be used to loosen any component that sits on a shaft and is freely accessible from the outside.</p>		K-20-1+S-T	20-1+S, 1-95-P, 1- V-100-P, 699915	2,64 kg	1	281,40 EUR









Storage / Presentation > K-Outside > K-2030

K-2030-1+A	Ku-NET	Item number				Price
<p>The 2- and 3-arm universal puller set with narrow, quick-adjustable puller hooks of the 2030 series is used for pulling off bearings, gears, washers etc. for narrow and poorly accessible gaps. The series convinces with its versatile design possibilities.</p>		K-2030-1+A	600-17, 1- V-100-S, 1-90-S, 20-1-T	4,755 kg	1	576,80 EUR

KS-2030-1-193+S	Ku-STA	Item number				Price
<p>The 2- and 3-arm universal puller kit with narrow puller hooks is used to pull off bearings, gears, washers etc. for narrow and poorly accessible spaces. The kit allows switching between 2- and 3-arm pullers and different hooks.</p>		KS-2030-1-193+S	20-1+S, 1-193-S, 30-1-T, 1-93-E	4,22 kg	1	589,20 EUR

K-2030-10	Ku-STA	Item number				Price
<p>The 2- and 3-arm universal puller kit of the 2030 series is used to pull off bearings, gears, washers, etc. The kit allows the assembly of 8 different puller models by combining pullers and extensions.</p>		K-2030-10	20-10-P3, 614250, 1-190-E	9,19 kg	1	889,40 EUR

K-2030-10-S	Ku-STA	Item number				Price
<p>The 2- and 3-arm universal puller kit with narrow pullers of the 2030 series is used for pulling off bearings, gears, washers etc. for narrow and poorly accessible gaps. The kit allows the assembly of 8 different puller models.</p>		K-2030-10-S	20-10-SP, 30-10-SP, 614250	8,92 kg	1	1.012,20 EUR

K-2030-10-S-T	Ku-STA	Item number				Price
<p>The 2- and 3-arm universal puller kit with extremely narrow pullers is used for pulling off gearwheels, bearings, pinions, synchroniser bodies etc. for extremely narrow and poorly accessible gaps. The kit allows the assembly of 8 different puller models.</p>		K-2030-10-S-T	20-10-SP-T, 614250, 1-194-E	8,805 kg	1	1.012,20 EUR
<p>The 2- and 3-arm universal puller kit with quick-adjustable pullers of the 2030 series is used for pulling off bearings, gears, washers etc. The kit allows the assembly of 8 different puller models by combining pullers and extensions.</p>		K-2030-10+	614250, 1-92-E, 1-192-S, 1-252-S, 20-10+	9,26 kg	1	922,60 EUR
<p>The 2- and 3-arm universal puller kit with narrow, quick-adjustable pullers is used for pulling off bearings, gears, washers etc. for narrow and poorly accessible gaps. The kit allows the assembly of 8 different puller models.</p>		K-2030-10+S	20-10+S, 614250, 1-193-S, 1-253-S	8,5 kg	1	979,80 EUR
<p>The 2- and 3-arm universal extractor set with extremely narrow, quick-adjustable extractor hooks of the 2030 series is used for extracting gearwheels, bearings, pinions, synchronous bodies etc. for extremely narrow and poorly accessible gaps.</p>		K-2030-10+S-T	20-10+S-T, 614250, 1-195-S, 1-255-S	8,91 kg	1	1.044,96 EUR
<p>The 2- and 3-arm universal puller kit of the 2030 series is used for pulling off large bearings, gears, discs etc. The kit in strong design for commercial vehicles enables the assembly of 7 different puller models by combining pullers and extensions.</p>		K-2030-20	621220, 621355, 600-17, 2-150-S, 2-300-S, 2-V-150-P, 30-20-T, 2-150-E	14,575 kg	1	1.162,20 EUR
<p>The hydraulic 2- and 3-arm universal puller kit of the 2030 series is used for hydraulically pulling off large bearings, gears, pulleys, etc. The kit in a strong design for commercial vehicles allows the assembly of 14 different puller models.</p>		K-2030-20-B	621220, 621355, 600-17, 8-0-621, 2-150-S, 2-300-S, 2-V-150-S, 30-20-T, 2-150-E	15,94 kg	1	1.551,00 EUR

K-2030-20-S	Ku-STA	Item number				Price
The 2- and 3-arm universal puller kit with narrow pullers of the 2030 series is used for pulling off large bearings, gears, washers etc. for narrow and poorly accessible gaps. The strong kit allows the assembly of 7 different puller models.		K-2030-20-S	621220, 621355, 600-17, 2-151-S, 2-301-S, 2-V-150-P, 30-20-T	14,5 kg	1	1.423,00 EUR
K-2030-20+S	Ku-STA	Item number				Price
The 2- and 3-arm universal puller set with two different types of pullers is used for universal work when pulling off gear wheels, bearings, pinions and synchronous bodies. This set contains the basic set of pullers needed for universal work.		K-2030-20+S	621220, 621355, 2-152-P, 2-153-P, 2-302-P, 2- V-150-P, 699915, 30-20-T, 600-17	14,76 kg	1	1.163,82 EUR
K-2030-20+S+B	Ku-STA	Item number				Price
The 2- and 3-arm universal puller set with two different types of puller hooks and hydraulic spindle of the 2030 series is used for universal application when pulling off gearwheels, bearings, pinions and synchronous bodies. This set contains the basic equipment of pullers.		K-2030-20+S+B		14,22 kg	1	1.963,22 EUR

Optional extensions > Accessories > Thrust pieces

K-600	Ku-STA	Item number				Price
The interchangeable thrust piece set is considered the optimal supplement for KUKKO thrust spindles with interchangeable tips and can be used for any installation position. For individual adaptation to the shaft, the pressure piece is inserted into the spindle. A choice can be made between different pressure pieces.		K-600-A NEW	612140	0,61 kg	1	202,80 EUR
		K-600-B NEW	616180	0,705 kg	1	202,80 EUR
		K-600-C NEW	620260	0 kg	1	265,80 EUR
		K-600-D NEW	633370	0 kg	1	296,66 EUR
600-17	Ku-STA	Item number		Stück pieces		Price
The pressure piece kit is used to support the pressure spindle with a hollow shaft. The kit contains a total of three pressure pieces that have different diameters and can be combined with each other. Thrust pieces sit perfectly on the hollow shaft thanks to the stepped silhouette.		600-17	20; 32; 41	3	1	36,20 EUR

K-20-15	Ku-STA	Item number				Price
The Universal Extractor and Separator Kit is used for hydraulic extraction and separation of ball bearings, roller bearings, inner rings and other flush-fitting parts. The kit allows the assembly of 7 different extractor models through various combinations.		K-20-15	600-17, 8-0-621, 15-2, 18-2, 20-1+, 20-2+, 1-192-P, 2-302-P	21,61 kg	1	1.966,80 EUR

Pulling > Universal puller with sliding, always parallel Pulling hooks > 11









11-A	Ku-STA	Item number				Price
The extra strong, 3-arm universal puller is used to remove heavy bearings, gears and discs in all standard sizes. It can be used to remove any component that sits on a shaft and is freely accessible from the outside. The robust hooks ensure safe removal.		11-0-A	105 mm - 375 mm	200 mm	1	1.505,20 EUR
		11-0-A3	105 mm - 375 mm	300 mm	1	1.472,60 EUR
		11-0-A4	105 mm - 375 mm	400 mm	1	1.520,60 EUR
		11-0-A5	105 mm - 375 mm	500 mm	1	2.415,00 EUR
		11-1-A	125 mm - 520 mm	200 mm	1	1.771,20 EUR
		11-1-A3	125 mm - 520 mm	300 mm	1	1.897,00 EUR
		11-1-A4	125 mm - 520 mm	400 mm	1	1.944,00 EUR
		11-1-A5	125 mm - 520 mm	500 mm	1	2.357,40 EUR
		11-2-A	155 mm - 650 mm	200 mm	1	1.988,60 EUR
		11-2-A3	155 mm - 650 mm	300 mm	1	2.124,80 EUR
		11-2-A4	155 mm - 650 mm	400 mm	1	2.172,80 EUR
		11-2-A5	155 mm - 650 mm	500 mm	1	2.233,80 EUR
11-AV	Ku-STA	Item number				Price
		11-0-AV	37 mm - 375 mm	300 mm	1	1.945,80 EUR
		11-1-AV	57 mm - 520 mm	300 mm	1	2.287,40 EUR
11-2-AV	87 mm - 650 mm	300 mm	1	2.796,80 EUR		
11-B	Ku-STA	Item number				Price
		11-0-B	105 mm - 375 mm	200 mm	1	2.278,60 EUR
		11-1-B	125 mm - 520 mm	200 mm	1	3.088,20 EUR
		11-2-B	155 mm - 650 mm	200 mm	1	2.657,80 EUR
11-3-B	155 mm - 650 mm	300 mm	1	2.877,00 EUR		

11-T	KU-STA	Item number				Price
<p>The 3-arm crossbar offers space for a total of three trigger hooks and thus ensures optimal load distribution. This guarantees a particularly secure hold of the trigger hooks on the part to be extracted. The hooks can be moved steplessly on the crossbar depending on the desired span.</p>		11-0-T	30-30+B, 11-0-A4, 11-0-A5, 11-0-B, 30-30-B, 30-30+, 11-0-BV, 30-30, 11-0-A, 30-4, 11-0-A3, 11-0-AV	6,765 kg	1	857,78 EUR
		11-520	30-40, 11-1-AV, 11-1-A, 11-1-A3, 11-1-B, 11-1-A4, 11-1-A5, 11-1-BV	12,565 kg	1	1.320,00 EUR
		11-650	11-2-A3, 30-5, 11-2-AV, 11-2-B, 11-3-B, 11-2-A, 11-2-A4, 11-2-A5, 11-2-BV	14,745 kg	1	1.320,00 EUR









Spare parts > Spare parts > Insert socket

11-20	KU-STA	Item number				Price
<p>The insert bushes are spare parts for 3-arm pullers with a strong design of series 11, which provide increased stability when fixed in the crosshead.</p>		11-0-20	11-0-A, 11-0-A3, 11-0-A4, 11-0-A5, 11-0-AV, 11-0-B, 11-0-BV	0,6 kg	1	160,00 EUR
		11-1-20	11-1-A, 11-1-A3, 11-1-A4, 11-1-A5, 11-2-A, 11-2-A3, 11-2-A4, 11-2-A5, 11-1-AV, 11-2-AV, 11-1-B, 11-2-B, 11-3-B, 11-1-BV, 11-2-BV	1,08 kg	1	200,00 EUR

Spare parts > Spare parts > Spindle

11-206	KU-STA	Item number				Price
<p>The crosshead inner bushings with spindle are spare parts for extra strong, 3-arm pullers of series 11. The collar of the spindle head prevents the key from slipping off.</p> 		11-0-206	11-0-A, 11-0-A3, 11-0-A4, 11-0-A5, 11-0-AV	3,315 kg	1	520,00 EUR
		11-1-206	11-1-A, 11-1-A3, 11-1-A4, 11-1-A5, 11-2-A, 11-2-A3, 11-2-A4, 11-2-A5, 11-1-AV, 11-2-AV	4,23 kg	1	760,00 EUR
11-BV	Ku-STA	Item number	 min. - max.	 max.		Price
<p>The extra powerful, 3-arm universal puller with adjustable clamping depth and grease-hydraulic spindle is used to pull off heavy, particularly tight bearings, gears and discs. It can be used to loosen components that sit on shafts and are freely accessible from the outside.</p> 		11-0-BV	37 mm - 375 mm	300 mm	1	2.516,60 EUR
		11-1-BV	57 mm - 520 mm	300 mm	1	3.024,40 EUR
		11-2-BV	87 mm - 650 mm	300 mm	1	3.358,60 EUR

Optional extensions > Accessories > Pulling hook

2-E	Ku-STA	Item number				Price
<p>The quick-adjustable standard puller hook is suitable for universal pullers. The robust design of the puller hook guarantees particularly safe and user-friendly extraction of bearings, gears and pulleys.</p> 		1-92-E	100 mm	0,28 kg	1	40,60 EUR
3-E	Ku-STA	Item number				Price
<p>The narrow, quickly adjustable trigger hook is suitable for universal pullers. Thanks to the narrow design of the puller hook, even narrow and poorly accessible spaces can be reached.</p> 		1-93-E	100 mm	0,255 kg	1	57,80 EUR
		1-193-E	200 mm	0,45 kg	1	74,40 EUR

0-E	Ku-STA	Item number	L			Price
<p>The standard puller hook is suitable for universal pullers. The robust design of the puller hook guarantees particularly safe pulling off of bearings, gears and discs</p>		1-190-E	200 mm	0,54 kg	1	71,40 EUR
		2-150-E	150 mm	0,6 kg	1	71,00 EUR
		3-200-E	200 mm	1,63 kg	1	150,80 EUR
1-E	Ku-STA	Item number	L			Price
<p>The narrow trigger hook is suitable for universal pullers. Thanks to the design of the puller hook, even narrow and poorly accessible gaps can be reached.</p>		1-191-E	200 mm	0,53 kg	1	84,60 EUR
4-E	Ku-STA	Item number	L			Price
<p>The extremely narrow trigger hook is suitable for universal pullers. The trapezoidal contact surface of the claw ensures that even very narrow and poorly accessible gaps can be reached.</p>		1-194-E	200 mm	0,45 kg	1	82,60 EUR
5-E	Ku-STA	Item number	L			Price
<p>The extremely narrow, quickly adjustable trigger hook is suitable for universal pullers. The trapezoidal contact surfaces of the claw ensure that even very narrow and poorly accessible gaps can be reached</p>		1-195-E	200 mm	0,45 kg	1	86,00 EUR

0-P

Ku-STA





The pair of two standard pullers is suitable for 2-arm universal pullers. The robust pullers guarantee particularly safe pulling of bearings, gears and pulleys.



Price

	Item number				Price
	1-90-P	20-10-P3, 20-1, 20-10, K-20-15, K-2030-10	0,555 kg	1	77,00 EUR
	1-190-P	20-10-P3, K-20-15, 20-1-2, 20-10-2, K-2030-10	1,12 kg	1	137,40 EUR
	1-250-P	20-10-P3, 20-1-25, 20-10-25, K-2030-10	1,36 kg	1	158,40 EUR
	1-400-P	20-1-4, 20-10-4	2,12 kg	1	200,80 EUR
	2-150-P	20-20-P2, 20-2-B, 20-20-B, 20-2, 20-20, K-20-15	1,24 kg	1	139,40 EUR
	2-300-P	20-20-P2, 20-2-3-B, 20-20-3-B, K-20-15, 20-2-3, 20-20-3	2,4 kg	1	252,20 EUR
	3-200-P	20-30-P3, 20-3-B, 20-30-B, 20-4-B, 20-3, 20-30, 20-4, 20-3- H, 20-30-H	3,27 kg	1	296,20 EUR
	3-250-P	20-3-25	3,725 kg	1	309,40 EUR
	3-300-P	20-30-3, 20-30-4, 20-4-3, 20-30-P3, 20-40-B, 20-40, 20-3-3-B, 20-30-3-B, 20-30-4-B, 20-4-3-B, 20-3-3	4,5 kg	1	359,20 EUR
	3-400-P	20-4-4, 20-40-4, 20-30-P3, 20-30-4, 20-30-4-B, 20-3-4-B, 20-4-4-B, 20-40-4-B, 20-3-4	5,33 kg	1	392,80 EUR



0-P	Ku-STA	Item number				Price
		3-500-P	20-3-5, 20-30-5, 20-4-5, 20-40-5, 20-3-5-B, 20-30-5-B, 20-4-5-B, 20-40-5-B	6,7 kg	1	432,60 EUR

0-S



Ku-STA



The set of three standard pullers is suitable for 3-arm universal pullers. The robust pullers guarantee particularly safe pulling of bearings, gears and discs.















Price

Item number					Price
1-90-S	30-1, 30-10, 30-10-P3, 30-1+, K-2030-10	0,835 kg	1		120,00 EUR
1-190-S	30-1-2, 30-10-2, 30-10-P3, K-2030-10	1,685 kg	1		206,20 EUR
1-250-S	30-10-P3, K-2030-10	2,04 kg	1		236,20 EUR
1-400-S		3,48 kg	1		302,80 EUR
2-150-S	30-2-B, 30-20-B, 30-2, 30-20-P2, 30-20	1,84 kg	1		208,40 EUR
2-300-S	30-2-3, 30-20-3, 30-2-3-B, 30-20-3-B, 30-20-P2	3,78 kg	1		377,60 EUR
3-200-S	30-40, 11-1-A, 11-0-B, 30-3-B, 11-1-B, 30-30-B, 11-2-B, 11-2-A, 30-3-P3, 30-3, 30-30, 11-0-A, 30-4	3,28 kg	1		443,40 EUR
3-250-S	30-3-25	5,695 kg	1		464,20 EUR
3-300-S	11-2-A3, 30-3-3, 30-3-3-B, 11-1-A3, 30-3-P3, 11-3-B, 11-0-A3	6,46 kg	1		540,00 EUR
3-400-S	11-0-A4, 30-3-4, 30-3-4-B, 11-1-A4, 30-3-P3, 11-2-A4	8,05 kg	1		588,00 EUR
3-500-S	11-0-A5, 30-3-5, 30-3-5-B, 11-1-A5, 11-2-A5	9,89 kg	1		648,20 EUR













1-P	Ku-STA	Item number				Price
<p>The pair of two narrow trigger hooks is suitable for 2-arm universal pullers. The narrow pullers ensure that even narrow and poorly accessible spaces can be reached.</p> 		1-91-P	20-1-S, 20-10-S, 20-10-SP, K-2030-10-S	0,515 kg	1	112,00 EUR
		1-191-P	20-10-SP, K-2030-10-S	1,075 kg	1	163,20 EUR
		1-251-P	20-10-SP, K-2030-10-S	1,305 kg	1	184,00 EUR
		1-401-P		2,075 kg	1	232,20 EUR
		2-151-P	20-2-S, 20-20-S, 20-20-SP	1,205 kg	1	232,20 EUR
		2-301-P	20-20-SP	2,535 kg	1	344,80 EUR
		3-201-P	20-3-S, 20-30-S, 20-30-SP	3,175 kg	1	337,60 EUR
		3-301-P	20-30-SP	4,28 kg	1	401,00 EUR
		3-401-P	20-30-SP	5,89 kg	1	465,60 EUR
		3-501-P		6,555 kg	1	675,80 EUR
1-S	Ku-STA	Item number				Price
<p>The set of three narrow pullers is suitable for 3-arm universal pullers. The narrow pullers ensure that even narrow and poorly accessible gaps can be reached.</p> 		1-91-S	30-10-SP, 30-1-S, 30-10-S	0,755 kg	1	160,00 EUR
		1-191-S	30-10-SP	1,605 kg	1	252,00 EUR
		1-251-S	30-10-SP	2,08 kg	1	275,60 EUR
		1-401-S		3,24 kg	1	351,80 EUR
		2-151-S	30-2-S, 30-20-S, 30-20-SP	1,78 kg	1	348,20 EUR
		2-301-S	30-20-SP	3,645 kg	1	517,80 EUR
		3-201-S	30-3-S, 30-3-SP	5,485 kg	1	507,00 EUR
		3-301-S	30-3-SP	6,39 kg	1	600,60 EUR
		3-401-S	30-3-SP	7,86 kg	1	698,60 EUR
		3-501-S		10,1 kg	1	1.013,60 EUR
4-P	Ku-STA	Item number				Price
<p>The pair of two extremely narrow pullers is suitable for 2-arm universal pullers. The trapezoidal contact surface of the claw ensures that even very narrow and poorly accessible gaps can be reached</p> 		1-94-P	20-1-S-T, 20-10-S-T, 20-10-SP-T	0,49 kg	1	100,20 EUR
		1-194-P	20-10-SP-T	1,06 kg	1	162,80 EUR
		1-254-P	20-10-SP-T	1,26 kg	1	184,00 EUR



4-S	KU-STA	Item number				Price
<p>The set of three extremely narrow pullers is suitable for 3-arm universal pullers. The trapezoidal contact surface of the claw ensures that even very narrow and poorly accessible gaps can be reached</p> 		1-94-S	30-10-SP-T, 30-1-S-T, 30-10-S-T	0,72 kg	1	160,00 EUR
		1-194-S	30-10-SP-T	1,56 kg	1	244,80 EUR
		1-254-S	30-10-SP-T	1,89 kg	1	275,60 EUR
2-P	Ku-STA	Item number				Price
<p>The pair of two quick-adjustable standard pullers is suitable for 2-arm universal pullers. The robust pullers guarantee particularly safe and user-friendly extraction of bearings, gears and pulleys.</p> 		1-92-P	20-10+2, 20-1+C, 20-10+, 20-10+C, 20-1+	0,58 kg	1	78,60 EUR
		1-192-P		1,17 kg	1	164,60 EUR
		1-252-P		1,41 kg	1	167,20 EUR
		2-152-P	20-2+3, 20-2+C, 20-20+C, 20-2+, 20-20+, 20-2+B, 20-20+B	1,26 kg	1	148,00 EUR
		2-302-P		2,59 kg	1	273,20 EUR
		3-202-P	20-3+C, 20-3+, 20-30+, 20-3+B, 20-30+B	3,33 kg	1	363,20 EUR
		3-302-P		4,505 kg	1	394,00 EUR
		3-402-P		5,505 kg	1	415,00 EUR
		3-502-P		6,35 kg	1	471,40 EUR
		2-S	Ku-STA	Item number		
<p>The set of three quick-adjustable standard pullers is suitable for 3-arm universal pullers. The robust pullers guarantee particularly safe and user-friendly extraction of bearings, gears and pulleys.</p> 		1-92-S	30-1+C, 30-10+C, 30-1+, 30-10+	0,92 kg	1	129,20 EUR
		1-192-S		1,86 kg	1	220,20 EUR
		1-252-S		2,305 kg	1	294,80 EUR
		2-152-S	30-2+C, 30-20+C, 30-2+, 30-20+, 30-2+B, 30-20+B	2,075 kg	1	239,00 EUR
		2-302-S		3,775 kg	1	426,80 EUR
		3-202-S	30-30+B, 30-3+C, 30-3+, 30-30+, 30-3+B	4,94 kg	1	458,40 EUR
		3-302-S		6,64 kg	1	590,20 EUR
		3-402-S		8,14 kg	1	621,60 EUR
		3-502-S		9,89 kg	1	675,40 EUR

3-P	Ku-STA	Item number				Price
<p>The pair of two narrow, quickly adjustable trigger hooks is suitable for 2-arm universal pullers. The narrow trigger hooks ensure that even narrow and poorly accessible gaps can be reached.</p> 		1-93-P	20-1+S, 20-10+S, 20-10+SP	0,53 kg	1	118,00 EUR
		1-193-P	20-10+SP	1,095 kg	1	148,80 EUR
		1-253-P	20-10+SP	1,34 kg	1	177,80 EUR
		2-153-P	20-2+S, 20-20+S, 20-20+SP	1,37 kg	1	216,20 EUR
		2-303-P	20-20+SP	2,58 kg	1	263,80 EUR
		3-203-P	20-3+S, 20-30-S, 20-30+SP, 20-30+S	3,16 kg	1	362,00 EUR
		3-303-P	20-30+SP	4,265 kg	1	454,40 EUR
		3-403-P	20-30+SP	6,155 kg	1	505,40 EUR
	3-503-P		6,51 kg	1	714,80 EUR	
3-S	Ku-STA	Item number				Price
<p>The set of three narrow, quickly adjustable trigger hooks is suitable for 3-arm universal pullers. The narrow pullers ensure that even narrow and poorly accessible gaps can be reached.</p> 		1-93-S	30-1+S, 30-10+S	0,85 kg	1	176,40 EUR
		1-193-S		1,62 kg	1	223,80 EUR
		1-253-S		2,18 kg	1	266,60 EUR
		2-153-S	30-2+S, 30-20+S	2,03 kg	1	329,20 EUR
		2-303-S		3,745 kg	1	396,40 EUR
		3-203-S	30-3+S	5,435 kg	1	543,60 EUR
		3-303-S		4,265 kg	1	681,80 EUR
		3-403-S		7,85 kg	1	759,80 EUR
			3-503-S		10,35 kg	1
5-P	Ku-STA	Item number				Price
<p>The pair of two extremely narrow, quickly adjustable trigger hooks is suitable for 2-arm universal pullers. The trapezoidal contact surfaces of the claw ensure that even very narrow and poorly accessible gaps can be reached.</p> 		1-95-P	20-1+S-T, 20-10+S-T, 20-1+S-T-C, 20-10+S-T-C	0,505 kg	1	118,00 EUR
		1-195-P		1,08 kg	1	172,40 EUR
		1-255-P		1,32 kg	1	177,80 EUR
5-S	Ku-STA	Item number				Price
<p>The set of three extremely narrow, quickly adjustable pullers is suitable for 3-arm universal pullers. The trapezoidal contact surface of the claw ensures that even very narrow and poorly accessible gaps can be reached.</p> 		1-95-S	30-10+S-T, 30-1+S-T	0,81 kg	1	176,40 EUR
		1-195-S		1,95 kg	1	258,40 EUR
		1-255-S		2,095 kg	1	266,60 EUR

6-P	KU-STA	Item number				Price
The pair of pullers is suitable for 2-arm pullers for gearwheels of the 20-10-V series. The robust puller hooks guarantee particularly safe pulling off of gearwheels.		1-96-P	20-10-V	0,46 kg	1	320,00 EUR
1-96/219-V	KU-STA	Item number				Price
The pair of pullers with clamp is suitable for 2-arm pullers for gearwheels of the 20-10-V series. The robust puller hooks guarantee a particularly safe pulling off of gear wheels.		1-96/219-V	20-10-V	0,75 kg	1	320,00 EUR

Optional extensions > Accessories > Pulling hook extensions



V-P	Ku-STA	Item number				Price
The pair of trigger hook extensions is used to extend the clamping depth. This allows components to be gripped that sit particularly deep on a shaft. The extensions can be combined with each other as desired and thus adapted to the required clamping depth		1-V-100-P	100 mm	20-1, 20-10	1	63,60 EUR
		1-V-150-P	150 mm	20-1, 20-10	1	84,00 EUR
		2-V-150-P	150 mm	20-2, 20-20	1	118,60 EUR
V-S	Ku-STA	Item number				Price
The set of trigger hook extensions is used to extend the clamping depth. This allows components to be gripped that sit particularly deep on a shaft. The extensions can be combined with each other as desired and thus adapted to the required clamping depth.		1-V-100-S	100 mm	30-1, 30-10	1	94,60 EUR
		1-V-150-S	150 mm	30-1, 30-10	1	125,20 EUR
		2-V-150-S	150 mm	30-2, 30-20	1	177,00 EUR
3-SV-S	KU-STA	Item number				Price
The quick adjuster in the set is a complete spare part for pullers with quick adjuster.		3-SV-S	30-3+S	0,185 kg	1	24,00 EUR

SP-E	KU-STA	Item number				Price
<p>The robust, height-adjustable extraction hook guarantees particularly safe extraction of bearings, gears and pulleys. The hook length can be individually adjusted in the range between 400-700 mm.</p> 		4-SP-E-1		1,32 kg	1	200,00 EUR
		4-SP-E	300 mm	4,34 kg	1	0,00
		5-SP-E	400 mm	10,5 kg	1	1.033,60 EUR
		5-SP-E-1		4,82 kg	1	520,00 EUR
SP-P	Ku-STA	Item number				Price
<p>The pair of two height-adjustable pullers is suitable for 2-arm pullers. The robust pullers guarantee particularly safe pulling of bearings, gears and pulleys.</p> 		4-SP-P	20-4-AV, 20-40-AV, 20-4-H, 20-40-H, 20-5-H	8,965 kg	1	740,80 EUR
		5-SP-P	20-40-H, 20-5-AV, 20-5	22,21 kg	1	1.384,80 EUR
SP-S	Ku-STA	Item number				Price
<p>The set of three height-adjustable pullers is suitable for 3-arm pullers. The robust pullers guarantee particularly safe pulling of bearings, gears and pulleys.</p> 		4-SP-S	11-1-AV, 30-5, 11-2-AV, Y28-11-1, Y28-11-2, 11-0-BV, 11-1-BV, 11-2-BV, 11-0-AV	13,65 kg	1	916,00 EUR



Pulling > External > Wheel hub puller

10-A	Ku-STA	Item number				Price
<p>The hydraulic wheel hub puller is used to pull off wheel hubs on cars and lorries. The grease-hydraulic spindle achieves a pulling force of 20 tonnes. Up to six Pulling hooks can be used on the dividing disc, making the puller universally applicable.</p> 		10-A	250 mm	6	1	1.693,60 EUR
		10-G	350 mm	7	1	2.222,80 EUR

























Spare parts > Spare parts > Dividing disc + hydraulic press

10-1	KU-STA	Item number				Price
<p>The spare parts for hydraulic wheel hub pullers of the 10-A and 10-G series ensure their perfect use. The hydraulic press provides the necessary force to pull off even stuck wheel hubs safely and without damage.</p> 		10-1	10-A, 10-G	5,86 kg	1	760,00 EUR
		10-3	10-A, 10-G	4,55 kg	1	520,00 EUR
		10-5	10-M, 10-A, 10-G	7,24 kg	1	760,00 EUR
10-6	KU-STA	Item number				Price
<p>The extractor hooks are suitable for extractors of the 10-A, 10-M and 10-G series. The robust extractor hooks guarantee particularly safe extraction of gearwheels.</p> 		10-6	10-M, 10-A, 10-G	0,72 kg	1	120,00 EUR















Spare parts > Spare parts > Thrust pieces

810-017	KU-STA	Item number				Price
<p>Pressure pieces are spare parts for various KUKKO tools, which are used for quick positioning and fixing of workpieces.</p> 		810-017	10-A, 10-G	0,135 kg	1	80,00 EUR
		810-117	10-A, 10-G	0,325 kg	1	70,70 EUR
10-M	KU-STA	Item number				Price
<p>The Wheel hub puller with disc-crossbeam is used to pull off wheel hubs on trucks. Up to six pulling hooks can be attached to the crossbar in different positions. The hooks can be adjusted to two different lengths for universal use.</p> 		10-M	350 mm	6	1	1.270,00 EUR
10-M-20	KU-STA	Item number				Price
<p>The bushing is a spare part for wheel hub pullers of the 10-M series. The bushing is adapted to the heavy mechanical design of the puller.</p> 		10-M-20	10-M	1,54 kg	1	120,00 EUR

Spare parts > Spare parts > Wear part

10-ERS	KU-STA	Item number				Price
The wearing parts kit for hydraulic wheel hub pullers is used to replace worn parts of the hydraulic wheel hub puller sets of the 10-A and 10-G series.		10-ERS	10-A, 10-G	1,215 kg	1	520,00 EUR
38	KU-STA	Item number				Price
The Wheel hub puller with disc-crossbeam is used to pull off wheel hubs on trucks. Up to five Pulling hooks can be attached to the disc crossbar and are freely movable on the crossbar. This means that the puller can also be used universally on different vehicle models.		38	250 mm	5	1	401,00 EUR
38-1	KU-STA	Item number				Price
The puller hook for wheel hub pullers of the 38 series is hooked onto the disc crossbar. The puller hooks are used to pull off wheel hubs on trucks.		38-1	38	0,495 kg	1	80,00 EUR
38-T	KU-STA	Item number				Price
The plate is a spare part for the universal wheel hub puller series 38.		38-T	38	1,655 kg	1	120,00 EUR
40	KU-STA	Item number				Price
The Wheel hub puller with disc-crossbeam is used to pull off wheel hubs on trucks. The spindle runs in an axially movable threaded bush if the spindle head needs to be struck to loosen the wheel hub. The free-moving T-handle guarantees use in confined spaces.		40-3	225 mm	3	1	421,40 EUR
		40-5	225 mm	5	1	527,00 EUR
40-1	KU-STA	Item number				Price
The pair of pullers is suitable for universal wheel hub pullers of the 40 series.		40-3-1	40-3, 40-5	1,39 kg	1	60,00 EUR

Optional extensions > Accessories > Impact crank

40-3-8	Ku-STA	Item number				Price
<p>The impact crank can be mounted on the spindle head for particularly tight wheel hubs to increase the extraction force. The wheel hub is loosened with strong blows on the crank.</p>		40-3-8	0,46 kg	38, 40-3, 40-5	1	46,40 EUR
<p>The plate complete with bush is a spare part for the universal wheel hub pullers, impact/shock model, of the series 40.</p>		04030005	40-3, 40-5	1,29 kg		120,00 EUR
<p>The Series 229 slide hammer with specially profiled shackle hook is used to release the wishbone from the suspension joint clamp and for work on the bodywork in the automotive and industrial sectors.</p>		229-1				Price
<p>The Series 229 slide hammer with specially profiled shackle hook is used to release the wishbone from the suspension joint clamp and for work on the bodywork in the automotive and industrial sectors.</p>		229-1	890 mm	12,095 kg	1	759,80 EUR
<p>The Series 229 wheel hub puller with slide hammer is used for removing all 4- and 5-hole wheel hubs on almost all types of cars in the automotive industry. The flange is designed with slots of different pitches to accommodate standard bolts.</p>		229-1-1				Price
		229-1-1	97 mm	435 mm	1	663,60 EUR

229-1-2	Ku-STA	Item number				Price
<p>The Series 229 wheel hub puller with slide hammer is used for removing all 4- and 5-hole wheel hubs on almost all types of cars in the automotive industry. The flange is designed with slots of different pitches to accommodate standard bolts.</p>		229-1-2	97 mm	800 mm	1	723,20 EUR





Optional extensions > Accessories > Hook with articulated joint

229-01	Ku-STA	Item number				Price
<p>The specially profiled U-hook with articulated joint is used together with the slide hammer 22-0-50 to release the wishbone from the suspension joint clamp and work on the car body in the automotive and industrial sectors.</p>		229-01	3,21 kg	229-1	1	143,60 EUR





229-100	KU-STA	Item number				Price
<p>The adapter is a spare part for hydraulic wheel hub pullers of the 229 series to convert them from hydraulic to slide hammer-based use. The adapter is needed to mount the slide hammer 22-0-2.</p>		229-100	229-2, 229-3	0,22 kg	1	80,00 EUR

229	Ku-STA	Item number		max.		Price
<p>The Series 229 hydraulic wheel hub puller is used for removing all 4- and 5-hole wheel hubs on almost all types of cars in the automotive and industrial sectors. The flange is designed with slots of different pitches to accommodate standard bolts.</p>		229-2	97 mm	10 t	1	546,80 EUR
		229-3	97 mm	15 t	1	728,60 EUR









229-03	KU-STA	Item number				Price
<p>The wheel hub puller is a spare part for hydraulic wheel hub pullers of the 229 series and wheel hub pullers with slide hammer of the 229-1-2 series. The wheel hub puller is used for pulling off all 4- and 5-hole wheel hubs on VW, Audi, Seat, Skoda, Opel, Volvo, Fiat, Renault etc. in trade, industry and workshops.</p>		229-03	229-1-1, 229-1-2, 229-2, 229-3	3,1 kg	1	520,00 EUR

229-3/20	KU-STA	Item number				Price
The Wheel Hub / Cardan Shaft Removal Supplement Kit is used together with the Series 229 Hydraulic Wheel Hub Pullers and complements the functions of the puller.		229-3/20	229-2, 229-3	2,545 kg	1	320,00 EUR





Grip / Hold > Grip / Hold > Clamping tools

100	DEAD	Item number				Price
The piston ring clamping bands of the 100 series are used for clamping the piston rings when installing the pistons in the cylinders in the automotive industry. The clamping bands in different sizes are ideal for a wide range of applications in the automotive industry.		100-1	57 mm - 125 mm	80 mm	1	80,60 EUR
		100-2	90 mm - 175 mm	80 mm	1	89,40 EUR
		100-3	90 mm - 175 mm	165 mm	1	122,00 EUR



Grip / Hold > Pliers > Piston ring fitting pliers

101-1	Ku-STA	Item number				Price
The piston ring pliers of the 101 series are used for expanding piston rings in trade, industry and workshops. The piston ring pliers are capable of expanding piston rings without destroying the original shape of the rings.		101-1	50 mm - 100 mm	200 mm	1	87,60 EUR
		101-2	90 mm - 150 mm	240 mm	1	114,40 EUR
101-3	Ku-STA	Item number				Price
The Universal Piston Ring Installation Pliers are used for efficient installation of piston rings. The pliers can fit piston rings gently and without problems without overstretching or other damage. The pliers are handy and can be used flexibly due to the easy adjustment.		101-3	0 mm - 140 mm	220 mm	1	749,00 EUR

Spare parts > Spare parts > Replacement tips

101-3-ES	KU-STA	Item number				Price
The pair of replacement tips with fastening material is a spare part for the universal piston ring application pliers 101-3. As a part affected by wear, it is worth replacing the tips of the application pliers when they are in poor condition.		101-3-ES	101-3	0,01 kg	1	80,00 EUR



Pulling > Removing > Piston pin pusher



102	Ku-STA	Item number	∅			Price
<p>The 102 series piston pin pushers are used to gently push in and push out piston pins in the automotive industry. The tool enables safe assembly and removal of piston pins using Thrust pieces without damaging the piston pin.</p> 		102-0	38 mm	0,17 kg	1	71,80 EUR
		102-1	100 mm	1,335 kg	1	223,00 EUR
103-1	Ku-STA	Item number	 max.			Price
<p>The valve spring tensioners of the 103 series are used for the damage-free installation and removal of valves for head-controlled engines in the automotive industry. The clamps allow safe removal of valves by tensioning the valve spring.</p> 		103-1	60 mm - 230 mm	1,21 kg	1	183,40 EUR

Spare parts > Spare parts > Claw





103-101	KU-STA	Item number				Price
<p>The spare jaw pairs are spare parts for the valve spring clamps 103. The jaws in straight or curved version are used for clamping different shaped workpieces.</p> 		103-101	103-1, 103-2	0,1 kg	1	60,00 EUR
		103-201	103-2	0,15 kg	1	60,00 EUR
		103-301	103-3	0,15 kg	1	60,00 EUR
		103-401	103-3	0,18 kg	1	60,00 EUR

Pulling > Removing > Chain / oil filter spanner

104	Ku-STA	Item number		∅		Price
<p>The strap spanner is a spare part used for dismantling oil filters in trade, industry and workshops. The strap can be tightened around the filter to dismantle it non-destructively by means of the handle.</p> 		104	0,26 kg	180	piece	63,00 EUR
104-32	Ku-STA	Item number		∅		Price
<p>The oil filter spanner with 32-link chain of the 104 series is a spare part used for oil filter disassembly in trade, industry and workshops. The chain can be reliably tensioned to dismantle the oil filter without destroying it.</p> 		104-32	0,36 kg	0-110	piece	114,60 EUR

105	Ku-STA	Item number		\emptyset		Price
<p>The oil filter spanners of the 105 series are spare parts used for loosening oil filters and other round screw connections in trade, industry and workshops.</p> 		105-0	0,33 kg	70-110	piece	107,60 EUR
		105-1	0,22 kg	70-110	piece	76,00 EUR
108	Ku-STA	Item number		\emptyset		Price
<p>The oil filter claw spanners are spare parts that are used to loosen oil filters and other round screw connections in trade, industry and workshops. The extremely strong and resilient oil filter claws are capable of removing even stuck oil filters safely and non-destructively.</p> 		108-1	0,38 kg	60-100	piece	62,00 EUR
		108-2	0,595 kg	65-120	piece	62,00 EUR
		108-3	1 kg	90-140	piece	328,80 EUR

Grip / Hold > Clamping clamp > Hand-held vices for a particularly firm grip

101	TU_FEI	Item number				Price
<p>The hand file blocks with wide jaws and wing nuts of the 101 series are used for flat clamping of workpieces. The inside of the jaw is grooved with a prismatic incision so that round and angular parts can be clamped.</p> 		101-100	100 mm	18 mm	1	67,20 EUR
		101-120	120 mm	22 mm	1	74,20 EUR
		101-130	130 mm	25 mm	1	79,80 EUR
		101-145	145 mm	28 mm	1	84,00 EUR
		101-160	160 mm	35 mm	1	88,20 EUR
		101-180	180 mm	40 mm	1	100,80 EUR
		101-200	200 mm	45 mm	1	126,00 EUR
101-101	TU_FEI	Item number				Price
<p>The spindles with wing nut and washer are spare parts for hand filing blocks of the 101 series. The wing nut is robust and resistant.</p> 		101-101	101-100	0,05 kg	1	18,62 EUR
		101-131	101-130	0,065 kg	1	29,68 EUR
		101-146	101-145	0,13 kg	1	29,68 EUR
		101-181	101-180	0,225 kg	1	29,68 EUR
		101-201	101-200	0,245 kg	1	54,04 EUR
102-120	TU_FEI	Item number				Price
<p>The 102 series pointed file vice with pointed jaw and wing nut is used for particularly firm gripping of workpieces on a small surface. The inside of the jaw is grooved with a prismatic incision so that round and angular parts can be clamped.</p> 		102-120	120 mm	20 mm	1	46,20 EUR
103	TU_FEI	Item number				Price
<p>The hand file blocks with wide jaws and spanners of the series 103 are used for flat clamping of workpieces. The inside of the jaw is grooved with a prismatic incision so that round and angular parts can be clamped.</p> 		103-160	160 mm	35 mm	1	88,20 EUR
		103-180	180 mm	40 mm	1	134,40 EUR
		103-200	200 mm	45 mm	1	168,00 EUR

103-000	TU_FEI	Item number				Price
<p>The spindles with nut are spare parts for manual chucks with key of the series 103. The very robust spindles are locked with the key.</p> 		103-161	103-160	0,1 kg	1	29,68 EUR
		103-181	103-180	0,185 kg	1	29,68 EUR
		103-211	103-200	0,25 kg	1	29,68 EUR





Spare parts > Spare parts > Key

103/109	TU_FEI	Item number				Price
<p>The keys for manual clamping vices are spare parts for the clamping vices of the series 103, 106 and 109, which are required for clamping workpieces.</p> 		103-162	103-160	0,076 kg	1	29,68 EUR
		103-182	103-180	0,15 kg	1	29,68 EUR
		103-202	103-200	0,26 kg	1	29,68 EUR
		106-202	106-200	0,32 kg	1	54,04 EUR
		109-162	109-160	0,26 kg	1	54,04 EUR
		109-182	109-180	0,205 kg	1	54,04 EUR
		109-252	109-250	5,555 kg	1	70,70 EUR

106	TU_FEI	Item number				Price
<p>The double strong hand file blocks with wide jaw, hexagon nut and spanner are used for clamping workpieces in medium-heavy work in iron construction. The inside of the jaw is grooved with a prismatic cut for clamping round and angular parts.</p> 		106-180	180 mm	40 mm	1	189,00 EUR
		106-200	200 mm	45 mm	1	228,20 EUR









106-201	TU_FEI	Item number				Price
<p>The spindles with nut are spare parts for manual vices of the 106, 107 and 109 series. The extra robust spindles are ideal for the extra strong and specialised vices.</p> 		106-201	106-200	0,315 kg	1	54,04 EUR
		107-201	107-200	0 kg	1	54,04 EUR

107	TU_FEI	Item number				Price
<p>The hand file clamps for plumbers with a wide jaw, hexagon nut and key are used for clamping workpieces when plumbers and plumbing technicians are working. The inside of the jaw is grooved with a prismatic cut for clamping round and angular parts.</p> 		107-200	200 mm	50 mm	1	250,60 EUR

109	TU_FEI	Item number				Price
<p>The machine blocks with wide jaws, hexagonal nuts and spanners of the 109 series are used for clamping workpieces under the highest loads. The inside of the jaw is grooved with a prismatic notch so that round and angular parts can be clamped.</p> 		109-160	160 mm	40 mm	1	184,80 EUR
		109-180	180 mm	40 mm	1	226,80 EUR
		109-200	200 mm	50 mm	1	273,00 EUR
		109-250	250 mm	60 mm	1	408,80 EUR
109-181	TU_FEI	Item number				Price
<p>The spindles with wing nut and washer are spare parts for machine clamping vices of the series 109.</p> 		109-181	109-180	0,47 kg	1	54,04 EUR
		109-251	109-250	0,685 kg	1	70,70 EUR
113-1	TU_FEI	Item number				Price
<p>The 113 series file clamps with fine jaws are used for clamping particularly fine workpieces. The 113 series is particularly suitable for fine work, e.g. on watches, and enables delicate and precise work on round and angular parts.</p> 		113-115	116 mm	6 mm	1	48,40 EUR
		113-116	116 mm	6 mm	1	48,40 EUR
		113-130	131 mm	7 mm	1	55,80 EUR
		113-131	131 mm	7 mm	1	55,80 EUR
113-117	TU_FEI	Item number				Price
<p>The spindle with wing nut is a spare part for 113 series stick file blocks and is made of high quality material for ideal application.</p> 		113-117	113-20, 113-3	0,06 kg	1	18,62 EUR

Pulling > External > Universal puller "Techno" with locking pin

110	Ku-STA	Item number				Price
<p>The 2-arm universal puller "Techno" with locking pin is used to remove bearings, gears and discs. The constant, always parallel and slim puller legs and the locking pin ensure particularly safe, non-destructive removal of parts seated on shafts.</p> 		110-01	22 mm - 50 mm	50 mm	1	100,20 EUR
		110-02	22 mm - 85 mm	50 mm	1	100,80 EUR
		110-1	28 mm - 100 mm	100 mm	1	100,20 EUR
		110-10	33 mm - 120 mm	100 mm	1	114,00 EUR
		110-2	42 mm - 165 mm	150 mm	1	179,80 EUR
		110-20	52 mm - 200 mm	150 mm	1	199,80 EUR
		110-3	62 mm - 250 mm	200 mm	1	351,60 EUR
		110-4	152 mm - 350 mm	250 mm	1	404,00 EUR

110-P	KU-STA	Item number				Price
<p>The pair of pullers is suitable for 2-arm universal pullers "Techno". The robust puller hooks guarantee particularly safe pulling off of bearings, gears and discs.</p> 		110-01-50-P	110-01, 110-02	0,094 kg	1	60,00 EUR
		110-1-100-P	110-1, 110-10	0,48 kg	1	80,00 EUR
		110-2-150-P	110-2, 110-20	0,96 kg	1	120,00 EUR
		110-3-200-P	110-3	1,65 kg	1	320,00 EUR
		110-4-250-P	110-4	2,09 kg	1	320,00 EUR
110-T	KU-STA	Item number				Price
<p>The traverses are spare parts for 2-arm universal pullers "Techno" of the series 110.</p> 		110-01-T	110-01	0,105 kg	1	60,00 EUR
		110-02-T	110-02	0,15 kg	1	60,00 EUR
		110-1-T	110-1	0,45 kg	1	80,00 EUR
		110-10-T	110-10	0,515 kg	1	80,00 EUR
		110-2-T	110-2	0,955 kg	1	120,00 EUR
		110-20-T	110-20	1,2 kg	1	160,00 EUR
		110-3-T	110-3	2,31 kg	1	200,00 EUR
		110-4-T	110-4	3,485 kg	1	320,00 EUR

Pulling > External > Puller for rolling bearings (Swedish model) with tapered wheel

112	Ku-STA	Item number				Price
			min. - max.	max.		
<p>The 2-arm puller with conical knurl has been developed for the proper removal of rolling bearings in co-operation with a Scandinavian ball bearing manufacturer. The consistently straight puller legs are specially designed for the centric removal of small and medium-sized bearings.</p> 		112-1	0 mm - 55 mm	45 mm	1	150,20 EUR
		112-10	0 mm - 65 mm	70 mm	1	154,20 EUR
		112-2	0 mm - 90 mm	70 mm	1	166,40 EUR
		112-20	0 mm - 100 mm	100 mm	1	194,20 EUR
		112-3	3 mm - 185 mm	165 mm	1	461,00 EUR

Pulling > External > Universal puller "VARIO" with spring-loaded safety catch

130	Ku-STA	Item number				Price
			min. - max.	max.		
<p>The 3-arm universal puller "VARIO" with spring-loaded drop protection is used to remove bearings, gears and discs in all standard sizes. It can be used to safely and non-destructively remove any component that sits on a shaft and is freely accessible from the outside.</p> 		130-10	20 mm - 150 mm	100 mm	1	141,80 EUR
		130-2	20 mm - 150 mm	150 mm	1	225,20 EUR
		130-20	20 mm - 260 mm	150 mm	1	283,60 EUR
		130-3	20 mm - 260 mm	200 mm	1	441,80 EUR

Spare parts > Spare parts > Clamping ring





















112-33	KU-STA	Item number				Price
<p>The clamping rings are spare parts for the 2- and 3-arm extractors for rolling bearings (Swedish model) of the 112 and 113 series. The clamping ring enables simplified adjustment of the clamping width.</p>		112-1-33	112-1, 112-10	0,025 kg	1	32,62 EUR
		112-2-33	112-2, 112-20	0,025 kg	1	54,32 EUR
		113-3-33	112-3	0,025 kg	1	54,32 EUR
112-P	KU-STA	Item number				Price
<p>The pair of pullers is suitable for 2-arm pullers for rolling bearings (Swedish model). The robust pullers guarantee particularly safe pulling of bearings, gears and discs.</p>		112-1-45-P	112-1	0,05 kg	1	119,28 EUR
		112-10-70-P	112-10	0,145 kg	1	119,28 EUR
		112-2-70-P	112-2	0,27 kg	1	120,00 EUR
		112-20-100-P	112-20	0,375 kg	1	120,00 EUR
		112-3-165-P	112-3	0,025 kg	1	336,42 EUR
112-T	KU-STA	Item number				Price
<p>The traverses are spare parts for 2-arm pullers for rolling bearings (Swedish model) of the 112 series.</p>		112-1-T	112-1, 112-10	0,096 kg	1	76,02 EUR
		112-2-T	112-2, 112-20	0,096 kg	1	76,02 EUR
		112-3-T	112-3	0,241 kg	1	119,28 EUR
112-100	TU_FEI	Item number				Price
<p>The 112-100 series tyre clamps with narrow jaws angled at 45 degrees are used for clamping tyres on drums, saw blades during sharpening, etc. The 112-100 series impresses with its application-oriented specialisation, which ensures optimum clamping.</p>		112-125	125 mm	32 mm	1	72,20 EUR
		112-150	150 mm	35 mm	1	93,60 EUR
112-2-060-P	KU-STA	Item number				Price
<p>The pair of springs and screws is a spare part for 2-arm pullers for rolling bearings (Swedish model) of the 112 series.</p>		112-2-060-P	112-2, 112-20	0,05 kg	1	40,00 EUR
113	Ku-STA	Item number				Price
<p>The 3-arm puller for rolling bearings with conical knurl is suitable for the non-destructive removal of bearings in limited environmental conditions. This prevents possible damage to the bearing and bearing seat during removal. Spring element and tightened clamping ring prevent slipping.</p>		113-20	1 mm - 125 mm	100 mm	1	294,00 EUR
		113-3	3 mm - 185 mm	165 mm	1	546,00 EUR





















113-T	KU-STA	Item number				Price
The crossheads are spare parts for 3-arm pullers for rolling bearings (Swedish model) of the 113 series.		113-20-T	113-20	0,025 kg	1	162,82 EUR
		113-3-T	113-3	0,025 kg	1	336,42 EUR
113-S	KU-STA	Item number				Price
The set of pullers is suitable for 3-arm pullers for rolling bearings (Swedish model). The robust pullers guarantee particularly safe pulling of bearings, gears and discs.		113-20-100-S		0,05 kg	1	160,00 EUR
		113-3-165-S		0,025 kg	1	450,38 EUR
113-206	KU-STA	Item number				Price
The spindle and bush is a spare part for 2- and 3-arm extractors for rolling bearings (Swedish model) of series 112 and 113.		113-3-206	112-3	0,025 kg	1	76,02 EUR

Pulling > External > Puller for camshaft sprockets

118	KU-STA	Item number				Price
The camshaft sprocket puller with sliding, always parallel puller legs is used to remove spoked camshaft sprockets in the vehicle workshop. Equipped with four special puller legs, the external removal tool guarantees particularly safe, non-destructive removal.		118-0	28 mm - 115 mm	43 mm	1	352,40 EUR
		118-1	42 mm - 115 mm	43 mm	1	281,60 EUR
118-01	KU-STA	Item number				Price
The claws are spare parts for camshaft sprocket pullers. The puller claws are specially designed for pulling off camshaft sprockets and enable the removal of stuck parts.		118-A-01	118-0	0,13 kg	1	80,00 EUR
		118-B-01	118-0	0,258 kg	1	52,00 EUR
		118-C-01	118-0	0,268 kg	1	72,80 EUR

Pulling > External > Alligator" puller with fixed puller legs and anti-slip protection

12	KU-STA	Item number	 min. - max.	 max.		Price
<p>The 3-armed "Alligator" puller with fixed puller legs and anti-slip protection is used to remove particularly tight bearings, gears and discs in all standard sizes. It can be used to loosen components that sit on shafts and are freely accessible from the outside.</p> 	12-1	12-1	0 mm - 100 mm	100 mm	1	209,40 EUR
		12-2	9 mm - 150 mm	125 mm	1	305,80 EUR
		12-3	16 mm - 200 mm	165 mm	1	448,20 EUR
12-S	KU-STA	Item number				Price
<p>The set of three standard pullers is suitable for 3-arm pullers "Alligator". The robust pullers guarantee a particularly safe pull-off of bearings, gears and pulleys.</p> 	12-1-100-S	12-1	0,425 kg	1	80,00 EUR	
	12-2-125-S	12-2	0,605 kg	1	80,00 EUR	
	12-3-180-S	12-3	1,425 kg	1	160,00 EUR	
12-206	KU-STA	Item number				Price
<p>The crosshead inner bushings with spindle are spare parts for 3-arm pullers "Alligator" with pre-adjustable puller hooks of series 12. The collar of the spindle head prevents the key from slipping off.</p> 	12-1-206	12-1	0,29 kg	1	120,00 EUR	
	12-2-206	12-2	0,58 kg	1	120,00 EUR	
	12-3-206	12-3	1,1 kg	1	200,00 EUR	
	12-4-206	12-4	2 kg	1	520,00 EUR	
	12-5-206	12-5	2,61 kg	1	520,00 EUR	
	12-6-206	12-6	6,3 kg	1	760,00 EUR	
	12-7-206	12-7	5,4 kg	1	760,00 EUR	
12-1-8	KU-STA	Item number				Price
<p>The keys are spare parts for the 3-arm pullers "Alligator" with pre-adjustable puller hooks of the series 12. The collar of the spindle head prevents the key from slipping off when locking.</p> 	12-1-8	12-1	0,13 kg	1	40,00 EUR	
	12-2-8	12-2	0,6 kg	1	40,00 EUR	
	12-3-8	12-3, 12-4, 12-5	0,235 kg	1	40,00 EUR	
	12-6-8	12-6, 12-7	0,247 kg	1	60,00 EUR	
12-T	KU-STA	Item number				Price
<p>The traverses are spare parts for 3-arm pullers with pre-adjustable puller hooks of series 12.</p> 	12-1-T	12-1	0,405 kg	1	60,00 EUR	
	12-2-T	12-2	0 kg	1	120,00 EUR	
	12-3-T	12-3	0,734 kg	1	120,00 EUR	
	12-4-52	12-4	1,34 kg	1	200,00 EUR	
	12-4-T	12-4, 12-5	2,975 kg	1	320,00 EUR	
	12-6-T	12-6	7,155 kg	1	1.000,00 EUR	
	12-7-T	12-7	11,5 kg	1	1.320,00 EUR	
	012500	12-5	1,375 kg	1	0,00	

12-A	Ku-STA	Item number	 min. - max.	 max.		Price
<p>The 3-arm puller with pre-adjustable pulling hooks for internal and external removal is used to remove bearings, gears, discs, etc. in all common sizes. It can be used to remove components that are either mounted on shafts and are freely accessible from the outside, or are located on the inside.</p> 		12-4	0 mm - 250 mm	225 mm	1	1.196,60 EUR
		12-5	0 mm - 350 mm	275 mm	1	2.677,00 EUR
		12-6	0 mm - 450 mm	300 mm	1	3.200,80 EUR
		12-7	0 mm - 650 mm	350 mm	1	3.816,60 EUR
12-E	KU-STA	Item number				Price
<p>The puller hook is suitable for 3-arm pullers of the 12 series. The robust puller hooks guarantee particularly safe pulling of bearings, gears and pulleys.</p> 		12-4-225-E	12-4	1,595 kg	1	320,00 EUR
		12-5-275-E	12-5	2,1 kg	1	520,00 EUR
		12-6-300-E	12-6	5,3 kg	1	520,00 EUR
		12-7-350-E	12-7	5 kg	1	760,00 EUR
120	Ku-STA	Item number	 min. - max.	 max.		Price
<p>The 2-arm universal puller "VARIO" with spring-loaded drop protection is used to remove bearings, gears and discs. Equipped with robust, always parallel puller legs, the puller ensures particularly safe, non-destructive removal of parts seated on shafts.</p> 		120-1	20 mm - 100 mm	100 mm	1	107,60 EUR
		120-10	20 mm - 150 mm	100 mm	1	118,40 EUR
		120-2	20 mm - 150 mm	150 mm	1	215,00 EUR
		120-20	10 mm - 250 mm	150 mm	1	236,60 EUR
		120-3	10 mm - 250 mm	200 mm	1	322,60 EUR
		120-30	10 mm - 350 mm	200 mm	1	384,40 EUR
120-T	KU-STA	Item number				Price
<p>The crossbars are spare parts for 2-arm universal pullers "Economy" of the 120 series. The pullers are continuously adjustable on the crossbar.</p> 		120-1-T	120-1	0,36 kg	1	60,00 EUR
		120-10-T	120-10	0,515 kg	1	80,00 EUR
		120-2-T	120-2	0,47 kg	1	80,00 EUR
		120-20-T	120-20	1,2 kg	1	120,00 EUR
		120-3-T	120-3	1,38 kg	1	160,00 EUR
		120-30-T	120-30	1,7 kg	1	320,00 EUR
130-P	KU-STA	Item number				Price
<p>The pair of two puller legs is suitable for the 2-arm universal puller "VARIO". The robust puller legs guarantee particularly safe, non-destructive dismantling.</p> 		0-100-P	120-1, 120-10	0,425 kg	1	60,00 EUR
		0-148-P	120-2	0,48 kg	1	80,00 EUR
		0-150-P	120-20	1,24 kg	1	80,00 EUR
		0-200-P	120-3, 120-30	1,54 kg	1	120,00 EUR

120-ST	KU-STA	Item number				Price
<p>The sales display for 2-arm universal pullers is the ideal solution for the presentation and storage of different sized 2-arm universal pullers. The 2-arm universal pullers "VARIO" with spring drop safety device are used for pulling off bearings, gears and washers in all common sizes.</p>		120-ST	120-1, 120-10, 120-2, 120-20, 120-3, 20-STL	14,79 kg	1	1.000,00 EUR





130-T	KU-STA	Item number				Price
<p>The crossbars are spare parts for 3-arm universal pullers "Economy" of the 130 series. The pullers are continuously adjustable on the crossbar.</p>		130-10-T	130-10	0,46 kg	1	80,00 EUR
		130-2-T	130-2	0,541 kg	1	160,00 EUR
		130-20-T	130-20	1,692 kg	1	200,00 EUR
		130-3-T	130-3	2,305 kg	1	320,00 EUR

130-S	KU-STA	Item number				Price
<p>The set of three puller legs is suitable for the 3-arm universal puller "VARIO". The robust puller legs guarantee particularly safe, non-destructive dismantling.</p>		0-100-S	130-10	0,561 kg	1	80,00 EUR
		0-148-S	130-2	0,72 kg	1	120,00 EUR
		0-150-S	130-20	1,89 kg	1	120,00 EUR
		0-200-S	130-3	2,12 kg	1	160,00 EUR

Cutting / loosening > Cutting / loosening > Screw punch

121	KU-STA	Item number	Ø	L		Price
<p>The screw punch is used for evenly punching plastic bumpers for distance sensors as well as for punching holes in thin-walled materials. Each screw punch consists of a punch, a die and a pressure screw in a particularly stable design.</p>		121-182	18,2	51,5 mm	1	142,80 EUR
		121-184	18,4	51,5 mm	1	142,80 EUR
		121-186	18,6	51,5 mm	1	142,80 EUR
		121-190	19	51,5 mm	1	142,80 EUR
		121-200	20	51,5 mm	1	142,80 EUR
		121-225	22,5	51,5 mm	1	142,80 EUR
		121-260	26	51,5 mm	1	142,80 EUR
		121-265	26,5	51,5 mm	1	142,80 EUR
		121-266	26,6	61,5 mm	1	142,80 EUR
		121-282	28,2	61,5 mm	1	142,80 EUR
		121-293	29,3	61,5 mm	1	142,80 EUR
		121-319	31,9	61,5 mm	1	142,80 EUR
		121-326	32,6	61,5 mm	1	142,80 EUR
		121-389	38,9	61,5 mm	1	142,80 EUR

Pulling > Removing > Tool for brakes

123	Ku-STA	Item number				Price
<p>The ejector levers for disc brake pads from the 123 series are used to remove jammed brake pads from the fixed calliper of the disc brakes in the automotive sector.</p> 	123	400 mm	0,595 kg	1	46,20 EUR	
	123-2	400 mm	0,505 kg	1	59,20 EUR	
124-K	Ku-STA	Item number				Price
<p>The car pulley puller set for all vehicle types is used for removing multi-groove pulleys up to a diameter of 195 mm in the automotive sector. The 2-arm design enables space-saving work that even works under full load.</p> 	124-K	195 mm	68 mm - 88 mm	1	410,60 EUR	
124-K-06	KU-STA	Item number				Price
<p>The mechanical spindle is a spare part for the 124-K series passenger car pulley puller set. The collar of the spindle head prevents the key from slipping off.</p> 	124-K-06	124-K	0,18 kg	1	80,00 EUR	
124-20-01-P	KU-STA	Item number				Price
<p>The pairs of puller claws are spare parts for special 2-arm pullers of the 124 series. Depending on the version, these are used to pull out vibration dampers or toothed belt pulleys.</p> 	124-20-11-P		1,06 kg	1	160,00 EUR	
	124-20-01-P		0,405 kg	1	120,00 EUR	
126	Ku-STA	Item number				Price
<p>The brake calliper tool range from the 126 series is used for quick and time-saving repairs to brake callipers in the automotive industry. The range provides all tools and accessories for general use in the maintenance of motor vehicles.</p> 	126-10	126-00, 126-01, 126-02, 126-03, 126-04, 127	2,46 kg	1	582,60 EUR	
	126-01		0,105 kg	1	23,00 EUR	
	126-02		0,06 kg	1	40,00 EUR	
	126-03		0,28 kg	1	195,20 EUR	
	126-04		0,096 kg	1	22,60 EUR	
	127		0,1 kg	1	92,40 EUR	

126-15	Ku-STA	Item number				Price
<p>The brake piston resetter from the 126-15 series is used to reset pistons on 6-piston brake callipers in the automotive industry. The heavy-duty version of the resetter also enables the resetting of high-performance brake callipers from heavy or very powerful brake callipers.</p> 		126-00	66 mm	1,845 kg	1	257,80 EUR
		126-15	290 mm	0 kg	1	323,00 EUR





Pulling > Removing > Direct pressure ball joint puller





127-0	Ku-STA	Item number				Price
<p>The bell-shaped direct pressure ball joint puller from the 127 series is used for pressing out the ball studs when removing ball joints as well as tie rod ends on tie rods in automotive and industrial applications. The puller enables damage-free work and is ideal when space is limited.</p> 		127-2	33,5 mm	58 mm	1	110,60 EUR
		127-3	34 mm	63 mm	1	115,20 EUR
		127-4	37 mm	58 mm	1	143,60 EUR
		127-55 NEW	32 mm	95 mm	1	159,60 EUR

128	Ku-STA	Item number				Price
<p>The bell-shaped ball joint puller from the 128 series is used to press out the ball studs when removing ball joints and tie rod ends on tie rods for all vehicle types. The puller enables damage-free work and is ideal when there is a lot of space available.</p> 		128-1	18 mm	40 mm	1	69,40 EUR
		128-2	23 mm	48 mm	1	94,60 EUR
		128-3	29 mm	63 mm	1	125,60 EUR
		128-4	40 mm	100 mm	1	168,20 EUR
		128-5	46 mm	100 mm	1	246,20 EUR
		128-6 NEW	55 mm	100 mm	1	609,00 EUR

Spare parts > Spare parts > Body





12820314	KU-STA	Item number				Price
<p>The replacement bodies are spare parts for the ball joint extractors of the 128-2 series. A damaged basic body can be replaced in this way.</p> 		12820314	128-2	0,41 kg	1	40,00 EUR





128-0	Ku-STA	Item number				Price
<p>The Series 128 ball joint puller is used for pressing out the ball studs when removing ball joints as well as tie rod ends on track rods in automotive and industrial applications. The puller enables damage-free work and is ideal when there is a lot of space available.</p> 		128-30 NEW	46 mm	85 mm	1	184,80 EUR
		128-40 NEW	39 mm	85 mm	1	226,80 EUR
		128-50 NEW	46 mm	85 mm	1	266,00 EUR
		128-60 NEW	55 mm	85 mm	1	672,00 EUR







128-H	Ku-STA	Item number				Price
<p>The hydraulic ball joint extractor of the 128-H series is used to press out the ball journals when removing ball joints and tie rod ends on tie rods in automotive and industrial applications. It enables damage-free work and is ideal when there is a lot of space available.</p> 		128-30-H NEW	46 mm	85 mm	1	639,80 EUR
		128-40-H NEW	39 mm	85 mm	1	681,80 EUR
		128-50-H NEW	46 mm	85 mm	1	1.159,20 EUR
		128-60-H NEW	55 mm	85 mm	1	1.062,60 EUR

Pulling > Removing > Windscreen wiper squeegee





128-F-60	Ku-STA	Item number	 min. - max.			Price
<p>The universal windscreen wiper pullers with adjustable clamping width of the 128-F-60 series are used to pull off stuck, rusted and recessed windscreen wiper arms in the automotive industry. The spring mechanism springs back to keep the pulling hooks under tension. Thanks to interchangeable hooks, the puller can also be used for deep-seated wiper arms.</p> 		128-F-60 NEW	16 mm - 38 mm	50 mm	1	344,40 EUR

128-DS	Ku-STA	Item number				Price
<p>The Thrust piece is a spare part for the KUKKO system for repair work on the VW T4 suspension joint.</p> 		128-DS-36 NEW	128-F-SW	0,018 kg	1	63,00 EUR
		128-DS-40 NEW	128-T-4	0,018 kg	1	63,00 EUR
		128-DS-52 NEW	128-T-4	0 kg	1	63,00 EUR





128-F	Ku-STA	Item number	 min. - max.	 max.		Price
<p>The 2-arm universal wiper puller is used to pull off stuck, rusted and recessed wiper arms on windshields and rear windows. The pressure piece on the spindle provides the perfect contact surface and guarantees gentle removal.</p> 		128-F-SW	25 mm - 60 mm	50 mm	1	116,80 EUR





K-142	Ku-STA	Item number				Price
<p>The universal windscreen wiper puller sets are universal sets for pulling off stuck, rusted and recessed windscreen wiper arms on all vehicle models. The sets are able to pull off parts gently and safely even in tricky pull-off situations.</p> 		K-142/4	128-F-SW, 142-1, 142-4, 43-1	1,35 kg	1	487,40 EUR
		K-142/6	43-1, 128-F-SW, 142-1, 142-2, 142-3, 142-4	2,61 kg	1	768,00 EUR
128-F-SW17	KU-STA	Item number				Price
<p>The Thrust piece is a spare part for universal windscreen wiper squeegees, which is used to hold the wipers in place during the squeegee removal process.</p> 		128-F-SW17	128-F-SW	0,02 kg	1	40,00 EUR
128-P	KU-STA	Item number				Price
<p>The set of three standard pullers is suitable for 3-arm universal pullers. The robust pullers guarantee particularly safe pulling of bearings, gears and discs.</p> 		128-FSW-50-P	128-F-60, 128-F-SW	0,1 kg	1	60,00 EUR
128-SW06	KU-STA	Item number				Price
<p>The pressure spindle is a spare part for universal wiper arm pullers of the 128-F-SW series.</p> 		128-SW06	128-F-SW	0,06 kg	1	80,00 EUR
128-T-4	Ku-STA	Item number				Price
<p>The KUKKO system for repair work on suspension joints in the 128 series is used for fitting and removing suspension joints on the T4 in automotive and industrial applications. The system enables damage-free work and is ideal when there is a lot of space available.</p> 		128-T-4	58 mm	100 mm	1	667,80 EUR
K-128-T-4	Ku-STA	Item number				Price
<p>The KUKKO system for repair work on the suspension joint of the 128-T-4 series is used for mounting and dismantling the suspension joints on the VW T4. The system enables damage-free work and is optimal when there is a lot of space. It was developed especially for the VW T4.</p> 		K-128-T-4	128-T-4	1,715 kg	1	0,00

Spare parts > Spare parts > Insert plate





128-EP-00	KU-STA	Item number				Price
<p>The insert plates are spare parts for ball joint extractors, which are used to position or fix the extractor to the workpiece.</p> 	128-EP-40	128-T-4	0,145 kg	1	84,00 EUR	
	128-EP-46	128-T-4	0,125 kg	1	80,00 EUR	
	128-EP-51	128-T-4	0,125 kg	1	80,00 EUR	
	128-EP-55	128-T-4	0 kg	1	70,70 EUR	

Pulling > Removing > Lever pressure ball joint puller





129	Ku-STA	Item number				Price
<p>The Series 129 ball joint extractor with lever transmission is used to press out ball studs when removing ball joints and track rod knobs on track rods for cars and light vans. Thanks to its lever transmission, it can apply a lot of force in all cases.</p> 	129-0	20 mm	50 mm	1	179,80 EUR	
	129-0-25	25 mm	50 mm	1	179,80 EUR	
	129-0-29	29,5 mm	50 mm	1	179,80 EUR	
	129-0-DC-1	20 mm	50 mm	1	256,20 EUR	
	129-0-DC-2	20 mm	50 mm	1	199,80 EUR	

129-K	Ku-ERS	Item number				Price
<p>The replacement bodies are spare parts for various ball joint ejectors of the 129 series. A damaged basic body can be replaced in this way.</p> 	129014	129-0, 129-0- DC-2	0,602 kg	1	160,00 EUR	
	1293614	129-36-H, 129-36	3,125 kg	1	760,00 EUR	
	1292514	129-25	0,74 kg	1	120,00 EUR	
	1295014	129-5-50, 129-5-50- H10, 129-5-50- H20	2,525 kg	1	520,00 EUR	
	1294514	129-5-45, 129-5-45- H10, 129-5-45- H20	2,525 kg	1	200,00 EUR	
	129414	129-4	1,345 kg	1	160,00 EUR	
	129025	129-0-25	0,602 kg	1	160,00 EUR	
	129114	129-1	0,3117 kg	1	80,00 EUR	
	129214	129-2	0,607 kg	1	160,00 EUR	
	129314	129-3	1,1 kg	1	120,00 EUR	
	1293A14		0,62 kg	1	80,00 EUR	
	1293A3414		0 kg	1	119,28 EUR	
	1293A3214		0,607 kg	1	119,28 EUR	
	129514	129-5	2,235 kg	1	320,00 EUR	
	1295H14		2,175 kg	1	520,00 EUR	
	129614	129-6	5,605 kg	1	760,00 EUR	
	129914	129-0-29	0,5 kg	1	160,00 EUR	
	129DC1	129-0- DC-1	0,57 kg	1	160,00 EUR	





Spare parts > Spare parts > Screws

























129-26	KU-STA	Item number				Price
<p>The adjusting screws are spare parts for lever pressure ball joint pullers of the 129 series. They are needed to adjust the pullers.</p> 	129026	129-0, 129-0-25, 129-0-29, 129-0-DC-1, 129-0-DC-2	0,135 kg	1	60,00 EUR	
	129126	129-1	0,06 kg	1	60,00 EUR	
	129226	129-2	0,08 kg	1	60,00 EUR	
	1292526	129-25	0,19 kg	1	60,00 EUR	
	1293A26		0,19 kg	1	54,32 EUR	
	129426		0,24 kg	1	80,00 EUR	
	129506	129-4, 129-3, 129-5	0,44 kg	1	80,00 EUR	













Spare parts > Spare parts > Lever

129031	KU-STA	Item number				Price
<p>The levers are spare parts for the ball joint extractors of the 129 series. The lever transmission makes it possible to carry out even heavy work with the extractors.</p> 	129031	129-0, 129-0-25, 129-0-DC-1	0,385 kg	1	120,00 EUR	
	1292531	129-25	0,505 kg	1	120,00 EUR	
	1293631	129-36-H, 129-36	1,88 kg	1	520,00 EUR	
	1293A31		0,9 kg	1	80,00 EUR	
	1294531	129-5-45, 129-5-50, 129-5-45-H10, 129-5-45-H20, 129-5-50-H10, 129-5-50-H20	2,525 kg	1	200,00 EUR	
	129DC2	129-0-DC-2	2,4 kg	1	80,00 EUR	





Spare parts > Spare parts > Pin

129057	KU-STA	Item number				Price
<p>The pins are spare parts for ball joint extractors with lever transmission of the 129 series and universal ball joint extractors of the 129-25 series.</p> 	129057	129-0, 129-0-25, 129-0-29, 129-0-DC-1, 129-0-DC-2	0,055 kg	1	60,00 EUR	
	1292557	129-25	0,075 kg	1	40,00 EUR	

129131	KU-STA	Item number				Price	
<p>The clamping levers are spare parts for ball joint extractors from the 129 series. The lever transmission makes it possible to carry out even heavy-duty work with the extractors (spare part is coloured green).</p> 		129131	129-1	0,24 kg	1	80,00 EUR	
		129231	129-2	0,345 kg	1	80,00 EUR	
		129331	129-3-H, 129-4-H, 129-4, 129-3	1,055 kg	1	60,00 EUR	
		129531	129-5	1,465 kg	1	320,00 EUR	
		129931	129-0-29	0,385 kg	1	80,00 EUR	
	<p>129-1</p> <p>Ku-STA</p>	Item number				Price	
<p>The Series 129 ball joint extractor with lever transmission is used to press out ball studs when removing ball joints and track rod knobs on track rods for cars and light vans. Thanks to its lever transmission, it can apply a lot of force in all cases.</p> 		129-1	22 mm	50 mm	1	139,40 EUR	
		129-1-B-1	31 mm	50 mm	1	174,80 EUR	
<p>129-2</p> <p>Ku-STA</p>	Item number				Price		
<p>The Series 129 ball joint extractor with lever transmission is used universally for cars, vans and medium trucks, universally for cars, vans and medium trucks, for pushing out ball pivots when removing ball joints and track rod knobs on track rods. Thanks to its lever transmission, it can apply a lot of force without taking up much space.</p> 		129-2	16 mm; 22 mm; 32 mm	70 mm	1	173,40 EUR	
	<p>129-25</p> <p>Ku-STA</p>	Item number				Price	
<p>The universal ball joint extractor from the 129 series is used to press out ball studs when removing ball joints from push rods and track rods on cars. Thanks to its lever transmission, the ball joint extractor can also apply a lot of force where there is hardly any access space.</p> 		129-25	19 mm	45 mm	1	179,80 EUR	
	<p>129-3-4</p> <p>Ku-STA</p>	Item number				Price	
<p>The Series 129 ball joint extractor with lever transmission is used to press out ball studs when removing ball joints and track rod knobs on track rods for medium and heavy trucks, buses and construction vehicles. Thanks to its lever transmission, the ball joint extractor can also apply a lot of force where there is hardly any access space. The 129 series impresses with its new layered design and variety of applications. Different versions enable optimum application in every situation.</p> 		129-3	NEW	31 mm	70 mm	1	233,80 EUR
		129-4	NEW	40 mm	85 mm	1	249,40 EUR
<p>129-3-A</p> <p>Ku-STA</p>	Item number				Price		
<p>The Series 129 ball joint extractor with lever transmission is used to press out the ball studs when removing ball joints and track rod knobs on track rods, especially for cars with aluminium chassis. Thanks to its lever transmission, it generates a lot of force even in tight spaces.</p> 		129-3-A	30 mm	65 mm	1	213,40 EUR	
		129-3-A-32	32 mm	65 mm	1	217,80 EUR	
		129-3-A-34	34 mm	65 mm	1	213,00 EUR	



129-06	KU-STA	Item number				Price
Spare parts for ball joint extractors replace components of ball joint extractors with and without hydraulics from the 129-3, 129-3-H, 129-5 and 129-5-H series (spare part is coloured green). 		129406	129-4-H, 129-4, 129-3	0,3 kg	1	120,00 EUR
		1293A06	129-3-A, 129-3-A-32	0,26 kg	1	80,00 EUR
		1294526L	129-5-45, 129-5-50, 129-5-45-H10, 129-5-45-H20, 129-5-50-H10, 129-5-50-H20	0,635 kg	1	80,00 EUR
		129456K	129-5-45, 129-5-45-H10, 129-5-45-H20	0,665 kg	1	120,00 EUR
		1294526K	129-5-45, 129-5-45-H10, 129-5-45-H20	0,445 kg	1	80,00 EUR
		129456L	129-5-45, 129-5-50, 129-5-45-H10, 129-5-45-H20, 129-5-50-H10, 129-5-50-H20	0,74 kg	1	120,00 EUR
129-H	Ku-STA	Item number				Price
The Series 129 Ball joint extractor with hydraulic spindle is used to remove particularly tight ball studs when removing ball joints and tie rod ends on track rods for medium-sized trucks, buses and construction vehicles. It is available in various sizes. 		129-3-H	31 mm	70 mm	1	480,00 EUR
		129-4-H	40 mm	85 mm	1	680,00 EUR
129-36	KU-STA	Item number				Price
The Series 129 track and push rod joint puller is used to hydraulically press out the ball studs when removing ball joints on push and track rods, especially for lorries and low-floor buses. 		129-36	36 mm	60 mm	1	934,60 EUR

129-36-ERS	KU-STA	Item number				Price
The bolt is a spare part for track and push rod joint pullers of the 129-36 series.		129-36-ERS	129-36-H, 129-36	0,43 kg	1	80,00 EUR
129-36-H	Ku-STA	Item number				Price
The Series 129 track and push rod joint puller with hydraulic lifting cylinder is used to press out the ball studs when removing ball joints on push and track rods, especially for lorries and low-floor buses. The extra heavy-duty version is suitable for hydraulic disassembly.		129-36-H	36 mm	60 mm	1	1.599,40 EUR
129-H-T	KU-STA	Item number				Price
The replacement bodies are spare parts for the ball joint ejectors with short hydraulic spindle of the 129-H series. A damaged basic body can be replaced in this way.		129-3H-T	129-3-H	0,925 kg	1	160,00 EUR
		129-4H-T	129-4-H	1,205 kg	1	200,00 EUR
129-4-30	Ku-STA	Item number				Price
The Series 129 ball joint extractor with lever transmission is used to press out the ball studs when removing ball joints and track rod knobs on track rods in cars. Thanks to its shape, the ball joint can be removed without touching other elements and without causing damage.		129-4-30	30 mm	70 mm	1	226,80 EUR
129-5	Ku-STA	Item number				Price
The ball joint ejector for heavy trucks in the 129 series is used to hydraulically eject the ball studs when removing ball joints on push and track rods, especially for medium and heavy trucks, buses and construction vehicles. Various versions allow for a wide range of applications.		129-5	36 mm	70 mm	1	453,00 EUR
129557	KU-STA	Item number				Price
The hinge shaft is a spare part for ball joint ejectors for heavy trucks of the 129-5 and 129-5-H series.		129557	129-5	0,16 kg	1	60,00 EUR

129-5-0	Ku-STA	Item number				Price
<p>The track and push rod joint puller for heavy trucks in the 129 series is used to mechanically press out the ball studs when removing ball joints on push and track rods. Different versions enable optimum application in every situation.</p> 		129-5-45	45 mm	120 mm	1	565,40 EUR
		129-5-50	55 mm	120 mm	1	632,60 EUR
1294557	KU-STA	Item number				Price
<p>The pressure pin is a spare part for track and push rod joint pullers with hydraulic lift cylinder of the 129-5-xx-H series.</p> 		1294557	129-5-45-H10, 129-5-45-H20, 129-5-50-H10, 129-5-50-H20	0,24 kg	1	40,00 EUR
129-5-45-ERS	KU-STA	Item number				Price
<p>The spare parts kit provides spare parts for track and push rod joint pullers for heavy trucks of the 129-5-xx and 129-5-xx-H series.</p> 		129-5-45-ERS	129-5-45, 129-5-50, 129-5-45-H10, 129-5-45-H20, 129-5-50-H10, 129-5-50-H20	7,53 kg	1	520,00 EUR
129-5-H-0	Ku-STA	Item number				Price
<p>The Series 129 track and push rod joint puller with hydraulic lifting cylinder is used to hydraulically press out the ball studs when removing ball joints on push and track rods, especially for lorries and low-floor buses. A hydraulic pump is required for the drive.</p> 		129-5-45-H10	45 mm	120 mm	1	1.140,60 EUR
		129-5-45-H20	45 mm	120 mm	1	1.307,00 EUR
		129-5-50-H10	55 mm	120 mm	1	1.206,20 EUR
		129-5-50-H20	55 mm	120 mm	1	1.372,40 EUR
129-5-H	Ku-STA	Item number				Price
<p>The Ball joint extractor with hydraulic spindle for heavy trucks in the 129 series is used to hydraulically eject the ball studs when removing ball joints on push and track rods, especially for medium and heavy trucks, buses and construction vehicles. It is available in various sizes.</p> 		129-5-H	36 mm	70 mm	1	886,40 EUR

129-6	Ku-STA	Item number		max.		Price
<p>The "Universal" series 129 truck ball joint extractor is used to extract particularly tight ball studs when removing ball joints from push and track rods on trucks, buses and construction vehicles. Different versions enable optimum application in every situation.</p> 		129-6	25 mm; 32 mm; 47 mm	10 t	1	1.496,60 EUR

Spare parts > Spare parts > Fork







129026	KU-STA	Item number				Price
<p>The forks are spare parts for ball joint ejectors of the 129 series and serve to support or fix the ejector to the ball joint.</p> 		1296026	129-6	0,625 kg	1	320,00 EUR
		1296126	129-6	0,99 kg	1	320,00 EUR
		1296226	129-6	1,045 kg	1	520,00 EUR
129617	KU-STA	Item number				Price
<p>The caps are spare parts for truck ball joint ejectors of the 129-6 series.</p> 		129617	129-6	0,465 kg	1	80,00 EUR

Pulling > Separating > For extracting ball bearings, roller bearings, inner races and other GASKET-seated parts





13	Ku-STA	Item number				Price
<p>The separator with 3 segments of the 13-TP series is used together with extractors of the 13 series for the gentle extraction of self-aligning and angular contact roller bearings in drive technology. The segments are attached to the inner ring and thus ensure uniform force transmission.</p> 		13-1 NEW	12 mm - 50 mm	30-10, 68-1	1	268,80 EUR
		13-2 NEW	25 mm - 100 mm	13-HP-180, 68-2	1	478,00 EUR
		13-3 NEW	50 mm - 160 mm	13-HP-180, 68-3	1	684,60 EUR

Storage / Presentation > Suitcase > K-Race





K-13	Ku-STA	Item number				Price
<p>The separator sets are used to pull off ball bearings, roller bearings, inner rings and other parts that lie flat when there is not enough space for pull-off hooks. The separator-puller process gently separates those parts before they can be pulled off from the outside.</p> 		13-A NEW	15-1, 18-1, 19-1-P	0 kg	1	568,00 EUR
		13-B NEW	15-2, 18-2, 19-2-P	0 kg	1	906,00 EUR
		13-C NEW	15-3, 18-3, 19-3-P	0 kg	1	1.398,00 EUR

13-T	KU-STA	Item number				Price
<p>The crossbars are spare parts for pullers of the 13-ME series.</p> 		13-T	13-1, 13-2, 13-3	4,26 kg	1	520,00 EUR
		68	Ku-STA	Item number		
<p>The Series 68 Pulling devices are used together with the Series 13 Separating devices for pulling flat or thin-walled parts when there is not enough space for Pulling hooks and these must first be separated.</p> 		68-1	NEW 160 mm	13-1	1	260,40 EUR
		68-2	NEW 280 mm	13-2	1	382,20 EUR
		68-3	NEW 330 mm	13-3	1	646,80 EUR









Screws / drive > Screws / drive > Impact spanner

133	KU-SCH	Item number	SW 	L 		Price
<p>The impact open-end spanners (DIN 133) of the 133 series are used for applications in the commercial vehicle, pipe industry, tank cleaning, petrochemical industry, steel and mining industry, etc. They can be used to operate hexagonal or square bolt heads or nuts without any problems.</p> 		133-24	24	160 mm	1	29,00 EUR
		133-75	75	400 mm	1	181,00 EUR
		133-80	80	405 mm	1	219,20 EUR
		133-85	85	405 mm	1	236,40 EUR
		133-90	90	455 mm	1	326,00 EUR
		133-95	95	455 mm	1	339,80 EUR
		133-100	100	500 mm	1	649,60 EUR
		133-105	105	500 mm	1	765,40 EUR
		133-110	110	500 mm	1	785,00 EUR
		133-115	115	525 mm	1	1.048,20 EUR
		133-70	70	370 mm	1	164,60 EUR
		133-65	65	350 mm	1	129,20 EUR
		133-60	60	320 mm	1	103,40 EUR
		133-27	27	180 mm	1	32,60 EUR
		133-30	30	190 mm	1	34,00 EUR
		133-32	32	195 mm	1	35,80 EUR
		133-34	34	195 mm	1	48,00 EUR
		133-36	36	210 mm	1	48,00 EUR
		133-41	41	225 mm	1	54,20 EUR
		133-46	46	255 mm	1	66,80 EUR
133-50	50	280 mm	1	76,60 EUR		
133-55	55	310 mm	1	95,40 EUR		
133-120	120	525 mm	1	1.090,00 EUR		











Pulling > Removing > Dividing forks









135	Ku-STA	Item number				Price
<p>The series 135 separating forks are used for loosening ball pin joints wedged in the cone seat, for loosening steering column levers, for removing shock absorbers and for other separating work of all kinds in the automotive and industrial sectors. They can be used universally.</p> 		135-1	18 mm	0,74 kg	1	92,40 EUR
		135-2	23 mm	0,8 kg	1	92,40 EUR
		135-3	29 mm	0,815 kg	1	92,40 EUR
		135-4	39 mm	1,465 kg	1	92,40 EUR
		135-5	45 mm	1,28 kg	1	92,40 EUR

Pulling > Removing > Wedge pulling pliers













139	KU-STA	Item number				Price		
<p>The key extraction pliers for keys in keyways are used for easy and damage-free extraction of stuck keys from the keyways of shafts. The pliers are able to remove even heavily fastened wedges from keyways and are designed for use on electric motors.</p> 	139-1	0 mm - 35 mm	144 mm	1	1.134,00 EUR			
		139-100	KU-STA	Item number				Price
		<p>The spare parts wedge extractor pliers for wedges in grooves guarantee the perfect use of the wedge extractor pliers. Available are handwheel, pulling spindle, adjusting spindle, base plate, a pair of clamping blocks as well as guide fork.</p> 	139-105	139-1	0,065 kg	1	60,00 EUR	
			139-106	139-1	0,285 kg	1	520,00 EUR	
			139-107	139-1	0,395 kg	1	320,00 EUR	
			139-108	139-1	0,223 kg	1	60,00 EUR	
139-112	139-1		0,37 kg	1	320,00 EUR			
139-126	139-1		0 kg	1	80,00 EUR			





Pulling > External > Puller with self-clamping, intersecting puller legs





14-S	KU-STA	Item number				Price
<p>The 2-arm puller with self-clamping, intersecting puller legs is used to pull pinions, pulleys, bearings and similar components for narrow gaps. Self-locking retaining pins guarantee quick and easy adjustment for variable clamping width ranges.</p> 	14-01	0 mm - 100 mm	85 mm	1	226,80 EUR	
	14-02	0 mm - 140 mm	125 mm	1	279,40 EUR	
	14-03	0 mm - 140 mm	160 mm	1	331,80 EUR	
14-P	KU-STA	Item number				Price
<p>The pair of cross hooks is suitable for 2-arm pullers of the 14 series. The cross hooks are ideal for narrow spaces when pulling off pinions, bearings and similar parts.</p> 	14-01-85-P	14-02, 14-01	0,185 kg	1	120,00 EUR	
	14-03-160-P	14-03	0,685 kg	1	200,00 EUR	
	14-1-85-P	14-1	0,22 kg	1	120,00 EUR	
	14-2-125-P	14-2	0,51 kg	1	120,00 EUR	
	14-3-160-P	14-3	0,68 kg	1	120,00 EUR	
14	KU-STA	Item number				Price
<p>The 2-arm puller with self-clamping, intersecting puller legs is used to pull pinions, pulleys, bearings and similar components for narrow gaps. Self-locking retaining pins guarantee quick and easy adjustment for variable clamping width ranges.</p> 	14-1	0 mm - 100 mm	85 mm	1	226,80 EUR	
	14-2	2 mm - 140 mm	125 mm	1	324,80 EUR	
	14-3	5 mm - 140 mm	160 mm	1	396,20 EUR	

060704	KU-STA	Item number				Price
<p>The pins are spare parts for 2-arm pullers with quick adjustment and cross hooks with claw feet of series 14.</p> 		060704	14-02, 14-01, 14-1	0,02 kg	1	40,00 EUR
		080804	14-03, 14-2, 14-3	0 kg	1	40,00 EUR
14-T	KU-STA	Item number				Price
<p>The crossbars are spare parts for 2-arm pullers with quick adjustment and cross hooks with claw feet of series 14.</p> 		14-1-T	14-02, 14-01, 14-1	0,072 kg	1	80,00 EUR
		14-2-T	14-03, 14-2, 14-3	0,155 kg	1	80,00 EUR





Pulling > External > Micro puller for small parts and modelling

Micro	KU-STA	Item number	 min. - max.	 max.		Price
<p>The micro puller is used to remove speedometer cables, pressure gauges, clocks and similar parts. The small parts puller is a helpful and reliable tool, especially for modelling. The space-saving model has narrow gripping jaws that are particularly suitable for tight spaces.</p> 		MICRO	2,5 mm - 10 mm	10 mm	1	108,00 EUR
140-S	KU-STA	Item number				Price
<p>The micro pullers are used to pull off speedometer shafts, pressure gauges, clocks and similar parts. Especially in model making, the handy and space-saving small parts puller is a helpful and reliable tool for narrow, hard-to-reach places.</p> 		140-S	140-1, 140-2, 140-3	0,625 kg	1	138,60 EUR
140	KU-STA	Item number	 min. - max.	 max.		Price
<p>The micro puller is used to remove speedometer cables, pressure gauges, clocks and similar parts. The small parts puller is a helpful and reliable tool, especially for modelling. The space-saving model has narrow gripping jaws that are particularly suitable for tight spaces.</p> 		140-1	2,5 mm - 10 mm	10 mm	1	46,20 EUR
		140-2	3,5 mm - 15 mm	15 mm	1	46,20 EUR
		140-3	5,5 mm - 18 mm	18 mm	1	46,20 EUR





140-S	KU-STA	Item number				Price		
<p>The micro pullers are used to pull off speedometer shafts, pressure gauges, clocks and similar parts. Especially in model making, the handy and space-saving small parts puller is a helpful and reliable tool for narrow, hard-to-reach places.</p> 	140-S	140-1,		0,625 kg	1	138,60 EUR		
		140-2, 140-3						
140-S-E	KU-STA	Item number				Price		
<p>The 5 replacement tips are spare parts for the micro extractor set and replace the tips enclosed there. As a precision tool, the tips must meet high standards.</p> 	140-S-E	140-1,		0,0005 kg	1	24,00 EUR		
		140-2, 140-3						
K-142	Ku-STA	Item number				Price		
<p>The universal windscreen wiper puller sets are universal sets for pulling off stuck, rusted and recessed windscreen wiper arms on all vehicle models. The sets are able to pull off parts gently and safely even in tricky pull-off situations.</p> 	K-142/4	128-F-SW, 142-1, 142-4, 43-1		1,35 kg	1	487,40 EUR		
	K-142/6	43-1, 128-F-SW, 142-1, 142-2, 142-3, 142-4					2,61 kg	1
142	Ku-STA	Item number				Price		
<p>The universal windscreen wiper pullers in the 142 series are used to pull off stuck, rusted and recessed windscreen wiper arms. The optimum bell shape and easy adjustability make the puller suitable for most models of standard windscreen wiper arms.</p> 	142-1	15 mm		45 mm	1	154,60 EUR		
	142-2	23,5 mm				45 mm	1	143,00 EUR
	142-3	15 mm				26,5 mm	1	148,00 EUR
	142-4	26,5 mm				16 mm	1	143,00 EUR
K-142	Ku-STA	Item number				Price		
<p>The universal windscreen wiper puller sets are universal sets for pulling off stuck, rusted and recessed windscreen wiper arms on all vehicle models. The sets are able to pull off parts gently and safely even in tricky pull-off situations.</p> 	K-142/4	128-F-SW, 142-1, 142-4, 43-1		1,35 kg	1	487,40 EUR		
	K-142/6	43-1, 128-F-SW, 142-1, 142-2, 142-3, 142-4					2,61 kg	1

142100	KU-STA	Item number				Price
<p>The complete spindle is a spare part for various universal windscreen wiper extractors of the 142 series. The spindle has a high load capacity.</p> 		142100	142-1, 142-2, 142-3	0,06 kg	1	60,00 EUR
		142400	142-4	0 kg	1	60,00 EUR
<p>The adjusting screw is a spare part for the universal windscreen wiper puller series 142-4. It is needed to adjust the puller.</p> 						

Grip / Hold > Grip / Hold > Spreader

145	Ku-STA	Item number				Price
<p>The spreaders for suspension strut and steering parts of the 145 series are used for safe and absolutely damage-free expansion of the mounts of suspension struts or steering parts from threads. They are especially suitable for gently expanding clamping fits on aluminium chassis.</p> 		145-2	95 mm	100 mm	1	79,80 EUR
		145-3	110 mm	115 mm	1	94,00 EUR

Storage / Presentation > Suitcase > K-Universal

K-20-15	Ku-STA	Item number				Price
<p>The Universal Extractor and Separator Kit is used for hydraulic extraction and separation of ball bearings, roller bearings, inner rings and other flush-fitting parts. The kit allows the assembly of 7 different extractor models through various combinations.</p> 		K-20-15	600-17, 8-0-621, 15-2, 18-2, 20-1+, 20-2+, 1-192-P, 2-302-P	21,61 kg	1	1.966,80 EUR





K-15	Ku-STA	Item number				Price
<p>The separator sets are used to pull off ball bearings, roller bearings, inner rings and other parts that lie flat when there is not enough space for pull-off hooks. The separator-puller process gently separates those parts before they can be pulled off from the outside.</p>		15-K	15-0, 18-0, 19-1-P	2,86 kg	1	379,40 EUR
		15-A	15-1, 18-1, 19-1-P	4,4 kg	1	530,80 EUR
		15-B	15-2, 18-2, 19-2-P	9,5 kg	1	645,20 EUR
		15-C	15-3, 18-3, 19-3-P	16,99 kg	1	1.021,00 EUR
		15-D	15-4, 18-4, 19-4-P	32,18 kg	1	2.443,60 EUR
		15-E	15-5, 18-5, 19-5-P	49 kg	1	3.102,20 EUR

15	Ku-STA	Item number				Price
<p>The Series 15 separating devices are used together with the Series 18 pulling devices to pull ball bearings, roller bearings, inner rings and other flat parts if there is not enough space for Pulling hooks and they have to be separated first.</p>		15-00	6 mm - 46 mm	18-00	1	104,20 EUR
		15-0	8 mm - 60 mm	18-0	1	113,80 EUR
		15-1	8 mm - 75 mm	18-1	1	146,60 EUR
		15-2	22 mm - 115 mm	18-2, 18-2-B	1	227,20 EUR
		15-3	30 mm - 150 mm	18-3, 18-3-B	1	367,60 EUR
		15-4	30 mm - 200 mm	18-4, 18-4-B	1	1.043,20 EUR
		15-5	30 mm - 250 mm	18-5, 18-5-B	1	1.487,00 EUR





29-A-69	Ku-STA	Item number				Price
<p>The universal separator, extractor and ball bearing extractor set series 29-A-69 is used for easy extraction of bearings, drums, pulleys, pole wheels and similar parts on motorbikes and other small engines. The set is suitable for separating and removing ball bearings.</p>		29-A-69	69-A, 225-150, 15-00	2,02 kg	1	532,60 EUR

Spare parts > Spare parts > Side bolt / draw bolt





015091	KU-STA	Item number				Price
<p>The side bolts with nut are spare parts for the cut-off devices of series 15. The side bolts are used to position and fix the cut-off jaws to the workpiece.</p>		015091	15-00, 15-1	0,025 kg	1	40,00 EUR
		015122	15-0, 15-K	0,12 kg	1	40,00 EUR





015145	KU-STA	Item number				Price
<p>The side bolts with nut are spare parts for the cut-off devices of series 15. The side bolts are used to position and fix the cut-off jaws to the workpiece.</p> 		015145	15-1, 15-A	0,14 kg	1	40,00 EUR
		015210	15-2, 15-B, K-20-15, 818-215, Y-215-2	0,375 kg	1	60,00 EUR
		015270	Y-215-3, 15-3, 15-C, 818-150, 818-215, 845-855, 845-858	0,72 kg	1	120,00 EUR
		015401	Y-215-4, Y-315-4, 15-4, 15-D	1,955 kg	1	160,00 EUR
		015450	Y-315-5, Y-515-5, 15-5, 15-E	2,885 kg	1	320,00 EUR
		015540	Y-515-6, Y-515-7	0 kg	1	760,00 EUR

Storage / Presentation > Suitcase > K-Innen

K-16	Ku-STA	Item number				Price
<p>The cylinder liner extractor set is used for extracting cylinder liners and similar parts. Three expanding bodies guarantee optimum adaptation of the internal extractor to the respective application and the POWER SCREW enables high force to be applied.</p> 		K-16-A NEW	16-21	11,76 kg	1	1.205,40 EUR
		K-16-B NEW	16-21	13,82 kg	1	1.642,20 EUR

Pulling > Internal > Internal extractor



16	Ku-STA	Item number				Price
<p>Series 16 cylinder liner extractors are used to extract cylinder liners and similar parts. Three expanding bodies guarantee optimum adaptation of the internal extractor to the respective application. The integrated POWER NUT enables a high level of force to be applied.</p> 		16-21	60 mm - 155 mm	-	1	600,60 EUR
		16-22	-	85 mm - 250 mm	1	437,60 EUR
		16-23 NEW	-	85 mm - 250 mm	1	873,60 EUR
		16	60 mm - 155 mm	85 mm - 250 mm	1	1.037,00 EUR
		16-2 NEW	60 mm - 155 mm	85 mm - 250 mm	1	1.570,80 EUR

K-16	Ku-STA	Item number				Price
<p>The cylinder liner extractor set is used for extracting cylinder liners and similar parts. Three expanding bodies guarantee optimum adaptation of the internal extractor to the respective application and the POWER SCREW enables high force to be applied.</p> 		K-16-A NEW	16-21	11,76 kg	1	1.205,40 EUR
		K-16-B NEW	16-21	13,82 kg	1	1.642,20 EUR





21-33	KU-STA	Item number				Price
<p>The spreader body sets are spare parts for the internal extractors 16-21, 21-89 or 21-90. Matching the respective internal extractors, the sets contain either two or three spreader bodies to replace the original ones.</p>		16-21-33		0,465 kg	1	160,00 EUR
		21-90-33	21-90	0,88 kg	1	120,00 EUR
		21-89-33	21-89	0,195 kg	1	80,00 EUR
16-21-6	KU-STA	Item number				Price
<p>The spreading spindle is a spare part for the large internal extractor of the 16-21 series. The spindle is available either with or without additional accessories, and is used to spread the spreading jaws during internal extraction.</p>		16-21-6	16-21	0,565 kg	1	160,00 EUR
		16-22-6	16-22	1,215 kg	1	120,00 EUR
16-22-T	KU-STA	Item number				Price
<p>The crossbar is a spare part for counter supports of the series 16-22.</p>		16-22-T	16-22	1,255 kg	1	200,00 EUR
16-22-V	KU-STA	Item number				Price
<p>The spindle extension is a spare part for the cylinder liner extractor set of the K-16 series. The extension simplifies the adaptation to different extracting situations.</p>		16-22-V	K-16-A, K-16-B	0 kg	1	80,00 EUR





















Grip / Hold > Grip / Hold > Flange driver

160-1	Ku-STA	Item number				Price
<p>The 160 series flange drivers are used in pairs for safe and accident-free disconnection of flange connections of pipelines. They enable the disconnection of large and heavy-duty flanges and thus make it easy to carry out maintenance work.</p>		160-1-E	80 - 250 mm	2,905 kg	1	343,00 EUR
		160-1-P	80 - 250 mm	5,87 kg	2	685,80 EUR
160-2	Ku-STA	Item number				Price
<p>The 160 series flange drivers are used in pairs for safe and accident-free disconnection of flange connections of pipelines. They enable the disconnection of large and heavy-duty flanges and thus make it easy to carry out maintenance work.</p>		160-2-E	250 - 1200 mm	8,95 kg	1	704,40 EUR
		160-2-P	250 - 1200 mm	17,65 kg	2	1.408,40 EUR

165	KU-STA	Item number		max.		Price
<p>The Series 165 universal spreader is used to quickly and safely spread flanges and similar parts of all types and sizes. It is a universal tool for a wide range of applications that has been designed for use in pairs.</p> 		165-E	10 mm - 75 mm	2 t	1	2.249,40 EUR
	165-E-01	KU-STA	Item number			
<p>The spindle is a spare part for universal spreaders of the 165-E series.</p> 		165-E-01	165-E	0,815 kg	1	320,00 EUR

Spare parts > Spare parts > Support foot / ring

165-E-06	KU-STA	Item number				Price
<p>The support feet are spare parts for universal spreaders. The interchangeable feet are attached with the screws included in the scope of delivery and provide a secure hold when spreading.</p> 		165-E-06	165-E	0,335 kg	1	320,00 EUR
165-E-10	KU-STA	Item number				Price
<p>The articulated ratchet is a spare part for universal spreaders of the 165 series. The smooth operation of the spreader is effected via the built-in reversible ratchet.</p> 		165-E-10	165-E	5,8 kg	1	200,00 EUR
165-E-31	KU-STA	Item number				Price
<p>The spreader lever is a spare part for the universal spreaders of the 165 series. The spreader lever increases the tension when spreading and makes the work easier.</p> 		165-E-31	165-E	0,25 kg	1	320,00 EUR
K-17	KU-STA	Item number				Price
<p>The separator sets are used to pull off ball bearings, roller bearings, inner rings and other parts that lie flat when there is not enough space for pull-off hooks. The separator-puller process is capable of gently separating those parts before external pull-off.</p> 		17-K	17-0, 18-0, 19-1-P	3,11 kg	1	457,40 EUR
		17-A	17-1, 18-1, 19-1-P	4,83 kg	1	546,80 EUR
		17-B	17-2, 18-2, 19-2-P	10,395 kg	1	786,20 EUR
		17-C	17-3, 18-3, 19-3-P	19 kg	1	1.100,40 EUR

17	KU-STA	Item number				Price
<p>The Series 17 separating devices are used together with the Series 18 pulling devices to pull ball bearings, roller bearings, inner rings and other flat parts if there is not enough space for Pulling hooks and they have to be separated first.</p>		17-0	8 mm - 60 mm	18-0	1	169,60 EUR
		17-1	8 mm - 75 mm	18-1	1	221,00 EUR
		17-2	22 mm - 115 mm	18-2, 18-2-B	1	321,80 EUR
		17-3	30 mm - 150 mm	18-3, 18-3-B	1	519,20 EUR
K-17	KU-STA	Item number				Price
<p>The separator sets are used to pull off ball bearings, roller bearings, inner rings and other parts that lie flat when there is not enough space for pull-off hooks. The separator-puller process is capable of gently separating those parts before external pull-off.</p>		17-K	17-0, 18-0, 19-1-P	3,11 kg	1	457,40 EUR
		17-A	17-1, 18-1, 19-1-P	4,83 kg	1	546,80 EUR
		17-B	17-2, 18-2, 19-2-P	10,395 kg	1	786,20 EUR
		17-C	17-3, 18-3, 19-3-P	19 kg	1	1.100,40 EUR
17-06	KU-STA	Item number				Price
<p>The pressure spindles are spare parts for separating devices with quick-clamping pressure spindles of series 17. The separating jaws can be clamped quickly and centrally with just one pressure spindle (spare part is coloured green).</p>		17-0-06	17-0, 17-K	0,1 kg	1	60,00 EUR
		17-1-06	17-1, 17-A	0,15 kg	1	60,00 EUR
		17-2-06	17-2, 17-B	0,235 kg	1	60,00 EUR
		17-3-06	17-3, 17-C	0,5 kg	1	80,00 EUR
17-T	KU-STA	Item number				Price
<p>The crossbars are spare parts for separators with quick-clamping pressure spindle of series 17 (spare part is coloured green).</p>		17-0-T	17-0, 17-K	0,16 kg	1	60,00 EUR
		17-1-T	17-1, 17-A	0,266 kg	1	60,00 EUR
		17-2-T	17-2, 17-B	0,62 kg	1	80,00 EUR
		17-3-T	17-3, 17-C	1,12 kg	1	120,00 EUR
017140	KU-STA	Item number				Price
<p>The side bolts with nut are spare parts for series 17 cut-off devices. The side bolts are used to position and fix the cut-off jaws on the workpiece (spare part is coloured green).</p>		017140	17-0, 17-K	0,1 kg	1	60,00 EUR
		017167	17-1, 17-A	0,16 kg	1	60,00 EUR
		017235	17-2, 17-B	0,395 kg	1	60,00 EUR
		017322	17-3, 17-C	0,82 kg	1	120,00 EUR

The Series 18 Pulling devices are used together with the Series 15 and 17 Separating devices for pulling flat or thin-walled parts if there is not enough space for Pulling hooks and these must first be separated.



	Item number				Price
<p>The Series 18 Pulling devices are used together with the Series 15 and 17 Separating devices for pulling flat or thin-walled parts if there is not enough space for Pulling hooks and these must first be separated.</p> 	18-00	61 mm	15-00; 19-00-P	1	96,20 EUR
	18-0	150 mm	15-0; 17-0; 19-1-P; 18-003A; 18-004A; 18-005A; 18-006A; 18-008A; 18-010A; 18-012A; 18-016A; 18-0-AS	1	96,60 EUR
	18-1	200 mm	15-1; 17-1; 19-1-P; 18-003A; 18-004A; 18-005A; 18-006A; 18-008A; 18-010A; 18-012A; 18-016A; 18-0-AS	1	172,20 EUR
	18-2	260 mm	8-0-621; 15-2; 17-2; 8-01; 19-2-P; 18-208A; 18-210A; 18-212A; 18-214A; 18-216A; 18-218A; 18-2-AS	1	255,40 EUR
	18-3	300 mm	15-3; 8-02; 17-3; 8-0-626; 19-3-P; 18-314A; 18-316A; 18-318A; 18-320A; 18-322A; 18-324A; 18-3-AS	1	431,60 EUR
	18-4	335 mm	15-4; 8-1-B; 19-4-P	1	1.037,40 EUR
	18-5	380 mm	15-5; 8-2-M; 19-5-P	1	1.509,00 EUR

K-15	KU-STA	Item number				Price
<p>The separator sets are used to pull off ball bearings, roller bearings, inner rings and other parts that lie flat when there is not enough space for pull-off hooks. The separator-puller process gently separates those parts before they can be pulled off from the outside.</p> 	15-K	15-0, 18-0, 19-1-P	2,86 kg	1	379,40 EUR	
	15-A	15-1, 18-1, 19-1-P	4,4 kg	1	530,80 EUR	
	15-B	15-2, 18-2, 19-2-P	9,5 kg	1	645,20 EUR	
	15-C	15-3, 18-3, 19-3-P	16,99 kg	1	1.021,00 EUR	
	15-D	15-4, 18-4, 19-4-P	32,18 kg	1	2.443,60 EUR	
	15-E	15-5, 18-5, 19-5-P	49 kg	1	3.102,20 EUR	

18-T	KU-STA	Item number				Price
<p>The crossbars are spare parts for pullers of the 18 series.</p> 	18-0-T	15-K, 17-K, 18-0	0,34 kg	1	80,00 EUR	
	18-1-T	15-A, 17-A, 18-1	0,92 kg	1	120,00 EUR	
	18-2-T	15-B, 17-B, 18-2, 18-2-B	1,48 kg	1	160,00 EUR	
	18-3-T	15-C, 17-C, 18-3, 18-3-B	3,25 kg	1	320,00 EUR	
	18-4-T	15-D, 18-4, 18-4-B	7,93 kg	1	760,00 EUR	
	18-5-T	15-E, 18-5, 18-5-B	13,935 kg	1	1.000,00 EUR	

Spare parts > Spare parts > Tension bolt

18-P	KU-STA	Item number				Price
<p>The pulling bolts are spare parts for pullers of the 18 series. The pullers allow the highest stability during pulling, as the separator and puller are firmly screwed together.</p> 	018175	15-K, 17-K, 18-0	0,165 kg	1	60,00 EUR	
	018265	15-A, 17-A, 18-1	0,345 kg	1	60,00 EUR	
	018275	15-B, 17-B, 18-2, 18-2-B	0,575 kg	1	80,00 EUR	
	018355	15-C, 17-C, 18-3, 18-3-B	1,03 kg	1	160,00 EUR	
	018450	18-4, 18-4-B	1,685 kg	1	160,00 EUR	
	018530	15-E, 18-5, 18-5-B	2,58 kg	1	200,00 EUR	

Spare parts > Spare parts > Nuts

672152	KU-STA	Item number				Price
The insert nut with fastening pin G1/2 - SW32 is a spare part for the extractor 18-2.		672152	18-2	0,07 kg	1	40,00 EUR
18-20	KU-STA	Item number				Price
The insert bushes are spare parts for the large puller 18-5, which provide increased stability when fixed in the crossbar.		18-5-20	18-5, 18-5-B	0,46 kg	1	200,00 EUR
18-4SAF	Ku-STA	Item number				Price
Puller set in metal box for SAF axles for SAF axles of types SK9030 / 9037 / 9042 / 11030 / 11242.		18-4SAF	18-4	24,43 kg	1	1.514,60 EUR
18-B	Ku-STA	Item number				Price
The Series 18 Pulling devices are used together with the Series 15 and 17 Separating devices for pulling flat or thin-walled parts if there is not enough space for Pulling hooks and these must first be separated.		18-2-B	260 mm	17-2; 15-2	1	637,20 EUR
		18-3-B	300 mm	17-3; 19-3-P; 15-3	1	877,80 EUR
		18-4-B	335 mm	19-4-P; 15-4	1	1.767,00 EUR
		18-5-B	380 mm	19-5-P; 15-5	1	2.486,60 EUR

Optional extensions > Accessories > Thread adapter

18-AS	Ku-STA	Item number				Price
The thread adapter set of the 18-AS series is used together with the pullers of the 18 series for pulling off and extracting components with threads. The separating-pulling process is capable of gently separating those parts first before they can be pulled off from the outside.		18-0-AS	M4-M5-M6-M8-M10-M12	18-0, 18-1	1	187,60 EUR
		18-2-AS	M8-M10-M12-M14-M16-M18	18-2	1	289,40 EUR
		18-3-AS	M14-M16-M18-M20-M22-M24	18-3	1	407,00 EUR

18-A	Ku-STA	Item number				Price
<p>The thread adapters of the 18-A series are used together with the pullers of the 18 series for pulling off and extracting components with threads. The separator-puller process is capable of gently separating those parts first before they can be pulled off from the outside.</p> 		18-003A	M3	18-0, 18-1	1	41,20 EUR
		18-214A	M14	18-2	1	85,60 EUR
		18-216A	M16	18-2	1	87,00 EUR
		18-218A	M18	18-2	1	89,00 EUR
		18-314A	M14	18-3	1	116,80 EUR
		18-316A	M16	18-3	1	119,20 EUR
		18-318A	M18x1,5	18-3	1	120,60 EUR
		18-320A	M20	18-3	1	122,00 EUR
		18-322A	M22	18-3	1	123,40 EUR
		18-212A	M12	18-2	1	84,00 EUR
		18-210A	M10	18-2	1	82,20 EUR
		18-004A	M4	18-0, 18-1	1	40,80 EUR
		18-005A	M5	18-0, 18-1	1	40,80 EUR
		18-006A	M6	18-0, 18-1	1	55,00 EUR
		18-008A	M8	18-0, 18-1	1	44,00 EUR
		18-010A	M10	18-0, 18-1	1	43,00 EUR
		18-012A	M12	18-0, 18-1	1	44,60 EUR
		18-016A	M16	18-0, 18-1	1	52,60 EUR
		18-208A	M8	18-2	1	81,60 EUR
		18-324A	M24	18-3	1	124,60 EUR

Optional extensions > Accessories > Extensions for pullers

19	Ku-STA	Item number				Price
<p>The extensions for pullers are used together with the pullers of series 18 in handicraft, industry and workshop to increase the clamping depth of the puller. The extensions are available in pairs in various lengths.</p> 		19-00-P	95 mm	18-00	1	29,00 EUR
		19-1-P	100 mm	18-0, 18-1	1	33,60 EUR
		19-2-P	100 mm	18-2	1	42,80 EUR
		19-3-P	100 mm	18-3, 18-3-B	1	64,00 EUR
		19-4-P	200 mm	18-4, 18-4-B	1	92,40 EUR
		19-5-P	200 mm	18-5, 18-5-B	1	117,20 EUR

Pulling > Removing > Picks and hooks

177-004	TU_SDR	Item number				Price
		177-004			1	41,58 EUR
177-H	TU_SDR	Item number				Price
<p>The hooks with 2-component comfort grip are used for loosening stuck sealing discs, Separating cables in a wiring harness and other work. The hooks enable sensitive and powerful work thanks to their two-component handle and high-quality workmanship.</p> 		177-H000	155 mm	3,5 mm	12	12,60 EUR

177-HP	TU_SDR	Item number				Price
<p>The picks & hooks with 2K comfort grip in the set are used for loosening stuck sealing discs, Separating cables in a wiring harness and other work. The picks & hooks enable sensitive and powerful work thanks to their handle and high-quality workmanship.</p>		177-HP04	155 mm	3,5 mm	1	50,40 EUR
		177-P000	155 mm	3,5 mm	1	12,60 EUR
		177-P045	155 mm	3,5 mm	12	12,60 EUR
		177-P090	155 mm	3,5 mm	12	12,60 EUR

Screws / drive > Screws / drive > Europeans











1900	KU-STA	Item number				Price
<p>The 1900 series European is used for pressing together and holding several workpieces. The adjustable spanner with double-sided jaws makes it easy to fix, clamp, tighten or loosen metallic as well as round or multi-edged bodies.</p>		1900-30	30 mm	150 mm	1	134,40 EUR
		1900-50	50 mm	175 mm	1	155,40 EUR
		1900-75	88 mm	260 mm	1	226,80 EUR

Spare parts > Spare parts > Protective caps







19030010-GR	KU-STA	Item number				Price
<p>The sets of 2 pairs of replacement protective caps are spare parts for Europeans of the 1900 series. The soft plastic protective caps improve the grip on metallic objects.</p>		19030010-GR	1900-30	0,01 kg	1	24,00 EUR
		19050010-GR	1900-50	0,015 kg	1	24,00 EUR
		19075010-GR	1900-75	0,04 kg	1	40,00 EUR





Pulling > External > Universal "Economy" puller for agriculture and workshops with versatile hook set

200-UM	KU-STA	Item number				Price
<p>The 2-arm universal puller "Economy" with a versatile puller leg set is used to remove bearings, gears and discs in all common sizes. It can be used to remove any component that sits on a shaft and is freely accessible from the outside.</p>		200-UM	0 mm - 250 mm	80 mm	1	617,80 EUR









200-U	KU-STA	Item number	 min. - max.	 max.		Price
<p>The 2-arm universal puller "Economy" with a versatile puller leg set is used to remove bearings, gears and discs in all common sizes. It can be used to remove any component that sits on a shaft and is freely accessible from the outside.</p> 		200-U	0 mm - 250 mm	80 mm	1	533,40 EUR
		200-U-P	KU-STA	Item number		
<p>The pair of puller hooks is suitable for farm and workshop pullers of the 200-U series. Four different pairs of puller hooks for different applications.</p> 		200-U-120B-P	200-U, 200-UM	1,265 kg	1	160,00 EUR
		200-U-180C-P	200-U, 200-UM	1,6 kg	1	160,00 EUR
		200-U-180D-P	200-U, 200-UM	1,235 kg	1	160,00 EUR
		200-U-80A-P	200-U, 200-UM	1,015 kg	1	160,00 EUR
200-T	KU-STA	Item number				Price
<p>The traverse is a spare part for farm and workshop pullers of the 200-U and 200-UM series.</p> 		200-U-T	200-U, 200-UM	1,17 kg	1	120,00 EUR

















Pulling > External > Tab puller with oscillating and 180° reversible puller legs













201	KU-STA	Item number	 min. - max.	 max.		Price
<p>The 2-jaw puller with adjustable reach with oscillating and reversible puller legs is used for the centric removal of bearings, gears and discs in all common sizes. It can be used to remove any component that sits on a shaft and is freely accessible from the outside.</p> 		201-0	0 mm - 100 mm	75 mm	1	66,20 EUR
		201-1	0 mm - 150 mm	85 mm	1	118,20 EUR
		201-2	0 mm - 220 mm	130 mm	1	179,80 EUR
		201-3	0 mm - 300 mm	260 mm	1	353,40 EUR
		201-4	0 mm - 380 mm	300 mm	1	416,40 EUR
		201-P	KU-STA	Item number		
<p>The pair of extractors is suitable for 2-arm universal extractors of the 201 series. The robust extractors guarantee particularly safe extraction of bearings, gears and pulleys.</p> 		201-0-75-P	201-0	0,23 kg	1	60,00 EUR
		201-1-85-P	201-1	0,445 kg	1	80,00 EUR
		201-2-130-P	201-2	1,135 kg	1	120,00 EUR
		201-3-260-P	201-3	2,64 kg	1	200,00 EUR
		201-4-300-P	201-4	0,926 kg	1	320,00 EUR

201-T	KU-STA	Item number				Price
<p>The crossbars are spare parts for 2-arm universal pullers with reversible puller hooks of the 201 series.</p> 		201-0-T	201-0, 41-3, 205-00	0,1 kg	1	40,00 EUR
		201-1-T	201-1, 201-S, 41-4, 208-01, 205-01	0,23 kg	1	40,00 EUR
		201-2-T	205-02-B, 205-1-B, 206-02-B, 201-2, 41-5, 208-02, 41-5-B, 205-02	0,455 kg	1	60,00 EUR
		201-3-T	205-3, 205-1-B, 205-2-B, 205-3-B, 201-3, 201-4, 208-2-B, 205-1, 205-2	1,14 kg	1	120,00 EUR



Pulling > External > Puller for fan wheels with oscillating and height-adjustable puller legs

201-S	KU-STA	Item number				Price
<p>The 2-jaw puller with adjustable reach is used to pull fan wheels in all common sizes. The oscillating puller legs adapt to any installation situation and can be used universally thanks to the adjustable clamping depth.</p> 		201-S	11 mm - 200 mm	200 mm	1	163,80 EUR
201-S-P	KU-STA	Item number				Price
<p>The pair of extractors is suitable for 2-arm universal extractors of the 201 series. The robust extractors guarantee particularly safe extraction of bearings, gears and pulleys.</p> 		201-S-P	201-S	0,625 kg	1	120,00 EUR



202-S	Ku-STA	Item number	 min. - max.	 max.		Price
<p>The 3-jaw puller with adjustable reach and adjustable height is used to pull fan wheels in all common sizes. Thanks to the particularly slim design, the puller legs reach through the two slots and grip the collar of the fan.</p> 		202-S	11 mm - 200 mm	200 mm	1	210,60 EUR
202-S-S	KU-STA	Item number	 KOMBINIERBAR KOMBINIERBAR			Price
<p>The set of pullers is suitable for 3-arm universal pullers of the 202 series. The robust pullers guarantee particularly safe pulling of bearings, gears and washers.</p> 		202-S-S	202-S	0,92 kg	1	120,00 EUR
202	Ku-STA	Item number	 min. - max.	 max.		Price
<p>The 3-arm puller with oscillating and reversible puller arms is used for the centric removal of bearings, gears and discs in all standard sizes. It can be used to remove any component that sits on a shaft and is freely accessible from the outside.</p> 		202-0	0 mm - 100 mm	75 mm	1	85,20 EUR
		202-1	18 mm - 150 mm	85 mm	1	132,80 EUR
		202-2	0 mm - 220 mm	130 mm	1	229,80 EUR
		202-3	0 mm - 300 mm	260 mm	1	455,20 EUR
		202-4	0 mm - 380 mm	300 mm	1	521,40 EUR
202-0-S	KU-STA	Item number	 KOMBINIERBAR KOMBINIERBAR			Price
<p>The set of pullers is suitable for 3-arm universal pullers of the 202 series. The robust pullers guarantee particularly safe pulling of bearings, gears and washers.</p> 		202-0-75-S	202-0, 203-0	0,34 kg	1	80,00 EUR
		202-1-85-S	202-1, 203-1	0,66 kg	1	120,00 EUR
		202-2-130-S	202-2, 203-2	1,69 kg	1	160,00 EUR
		202-3-260-S	202-3, 203-3	3,905 kg	1	320,00 EUR
		202-4-300-S	202-4, 203-4	0,926 kg	1	520,00 EUR





















202-T	KU-STA	Item number				Price
<p>The crossbars are spare parts for 3-arm universal pullers with reversible puller hooks of the 202 series.</p> 	202-0-T	206-00, 202-0, 42-3	0,115 kg	1	60,00 EUR	
	202-1-T	202-S, 206-01, 202-1, 209-01, 42-4	0,24 kg	1	60,00 EUR	
	202-2-T	206-02, 202-2, 206-02-B, 209-02, 42-5, 42-5-B	0,55 kg	1	80,00 EUR	
	202-3-T	206-1, 206-2, 202-3, 206-3, 202-4, 206-1-B, 206-2-B, 206-3-B	1,345 kg	1	160,00 EUR	
203	Ku-STA	Item number				Price
<p>The 3-arm puller with combination crosshead has oscillating and reversible puller legs and is used for centric removal of bearings, gears and discs. It can be used to remove any component that sits on a shaft and is freely accessible from the outside.</p> 	203-0	0 mm - 120 mm	75 mm	1	92,40 EUR	
	203-1	0 mm - 180 mm	85 mm	1	141,00 EUR	
	203-2	0 mm - 280 mm	130 mm	1	239,60 EUR	
	203-3	0 mm - 350 mm	260 mm	1	532,00 EUR	
	203-4	0 mm - 400 mm	300 mm	1	597,00 EUR	
203-T	KU-STA	Item number				Price
<p>The crossbars are spare parts for 3-arm combination pullers with reversible puller hooks of the 203 series.</p> 	203-0-T	203-0, 207-00	0,14 kg	1	60,00 EUR	
	203-1-T	203-1, 207-01	0,31 kg	1	60,00 EUR	
	203-2-T	207-02-B, 203-2, 207-02	0,665 kg	1	80,00 EUR	
	203-3-T	207-1-B, 207-2-B, 207-3-B, 203-3, 203-4, 207-1, 207-2, 207-3	1,5 kg	1	320,00 EUR	



Screws / drive > Screws / drive > Pin spanner

203-100	TU_WIN	Item number	SW 	Profil		Price
<p>The 203 series offset screwdriver sets are used for operating screw heads that are difficult to access. Hardness and torque comply with the ISO standard. The sets are inexpensive and compact, and in the practical plastic case they are ideal for presentation in the shop.</p> 		203-080	2,0; 2,5; 3,0; 4,0; 5,0; 6,0; 8,0; 10,0	Sechskant	10	14,56 EUR
		203-100	2; 2,5; 3; 4; 5; 6; 8; 10; 12; 14	Sechskant	10	30,00 EUR
		203-208	2,0; 2,5; 3,0; 4,0; 5,0; 6,0; 8,0; 10,0	Sechskant	10	14,98 EUR
203-110	TU_WIN	Item number	SW 		Profil	Price
<p>The 203 series offset screwdriver sets are used for operating screw heads that are difficult to access. Hardness and torque comply with the ISO standard. The series is inexpensive and compact, and in the practical plastic case it is ideal for presentation in the shop.</p> 		203-110	3/64; 1/16; 5/64; 3/32; 1/8; 5/32; 3/16; 1/4; 5/16; 3/8	10	Sechskant	15,40 EUR
		203-280	5/64; 3/32; 1/8; 5/32; 3/16; 1/4; 5/16; 3/8	10	Sechskant	14,98 EUR

Pulling > External > Bearing puller with fixed legs and lateral clamping clamp

204-0	Ku-STA	Item number	 min. - max.	 max.		Price
<p>The 2-armed "Cobra" bearing puller with lateral clamping clamp and separating claw is used to pull off flush-fitting ball bearings, bearing rings and workpieces. The special claw shape of the puller legs grips under the part to be extracted and releases it before the actual extraction process.</p> 		204-0	12 mm - 50 mm	70 mm	1	172,20 EUR
		204-02	26 mm - 90 mm	100 mm	1	266,20 EUR
27-A	Ku-STA	Item number				Price
<p>The universal extractor set of series 27-A is used for extracting, separating and internally extracting bearings, gears, washers, etc.. The set is versatile for external extraction, internal extraction and internal extraction with engagement in the ball bearing.</p> 		27-A	204-0, 21-0-E, 21-00-E, 21-01-E, 21-1-E, 21-2-E, 21-3-E, 21-4-E, 21-5-E, 43-001, 22-0-09	7,255 kg	1	1.587,20 EUR

204-0-P	KU-STA	Item number				Price
The pair of pullers is suitable for 2-arm bearing pullers "Cobra" of the series 204-0.		204-0-70-P	27-A, 204-0	0,17 kg	1	120,00 EUR
		204-02-100-P	204-02, 204-V	0,39 kg	1	120,00 EUR
204-T	KU-STA	Item number				Price
The cross bars are spare parts for 2-arm universal pullers with side clamp of series 204.		204-0-T	27-A, 204-0	0,116 kg	1	80,00 EUR
		204-1-T	204-1	0,375 kg	1	80,00 EUR
		204-2-T	204-V, 210-1, 204-2, 204-02	0,445 kg	1	120,00 EUR
		204-3-T	210-2, 210-3, 204-3	0,83 kg	1	120,00 EUR
204001	KU-STA	Item number				Price
The clamps are spare parts for 2-arm universal pullers with side clamp of the 204 series and 2-arm separating pullers "Cobra" with adjustable clamping depth of the 210 series. The clamp increases the contact pressure of the pullers many times over.		204001	27-A, 204-0	0,22 kg	1	60,00 EUR
		204101	204-1	0,345 kg	1	80,00 EUR
		204201	204-02, 204-V, 210-1, 210-2, 204-1, 204-2	0,55 kg	1	120,00 EUR
		204301	204-3	0,58 kg	1	160,00 EUR
		210201	210-3, 210-2	0,62 kg	1	160,00 EUR
204	Ku-STA	Item number				Price
The 2-armed "Cobra" bearing puller with lateral clamping clamp is used to remove particularly tight ball bearings, bearing rings and workpieces. It can be used to remove any component that sits on a shaft and is freely accessible from the outside.		204-1	6 mm - 80 mm	90 mm	1	194,20 EUR
		204-2	16 mm - 100 mm	100 mm	1	222,20 EUR
		204-3	6 mm - 150 mm	140 mm	1	361,20 EUR
204-P	KU-STA	Item number				Price
The pair of pullers is suitable for 2-arm universal pullers with side clamp of the 204 series.		204-1-90-P	204-1	0,34 kg	1	120,00 EUR
		204-2-100-P	204-2	0,485 kg	1	120,00 EUR
		204-3-140-P	204-3	0,855 kg	1	160,00 EUR

K-204-V-210-1	Ku-STA	Item number				Price
<p>The universal puller set with side clamp is used for separating and pulling off flush or flat bearings, gear wheels etc. and front axles of VW. The puller legs of the pullers are partly reversible, adjustable in height and have standard and separating puller hooks.</p> 	K-204-V-210-1	204-V, 210-1, 225-150	5,305 kg	1	568,60 EUR	
204-V	Ku-STA	Item number				Price
<p>The 2-arm bearing puller with lateral clamping clamp is used to remove particularly tight ball bearings, bearing rings and workpieces. It can be used to loosen any component that sits on a shaft and is freely accessible from the outside. The contact pressure of the legs is increased.</p> 	204-V	26 mm - 90 mm	100 mm	1	246,20 EUR	
204-V-06	KU-STA	Item number				Price
<p>The mechanical pressure spindle with adapter is a spare part for 2-arm puller for bearing inner rings "Cobra" with lateral clamp. The adapter fits all common axle bores, e.g. on VAG and other models.</p> 	204-V-06	204-V	0,495 kg	1	160,00 EUR	



Pulling > Removing > Steering column lever puller



204-44	Ku-STA	Item number				Price
<p>The mechanical universal steering column lever puller from the 204-44 series is used to pull off steering column levers on medium and heavy commercial vehicles. Thanks to its solid and stable design, it offers a variable solution for the robust but safe removal of steering column levers.</p> 	204-44	60 mm - 90 mm	70 mm	1	213,40 EUR	

201-000	TU_WIN	Item number	SW 	Profil		Price
<p>The angled screwdrivers ISO 2936 of the 201 series are used for operating screw heads that are difficult to access. Hardness and torque correspond to the ISO standard. The 201 series is inexpensive and compact and is available in a wide range of sizes to suit different hexagon heads.</p> 		201-105	1,5	Sechskant	50	0,56 EUR
		201-014	14,0	Sechskant	20	10,00 EUR
		201-015	15,0	Sechskant	20	13,72 EUR
		201-016	16,0	Sechskant	10	18,40 EUR
		201-017	17,0	Sechskant	10	16,40 EUR
		201-018	18,0	Sechskant	10	23,60 EUR
		201-019	19,0	Sechskant	10	23,60 EUR
		201-020	20,0	Sechskant	5	30,40 EUR
		201-021	21,0	Sechskant	5	40,40 EUR
		201-022	22,0	Sechskant	5	37,20 EUR
		201-024	24,0	Sechskant	1	45,40 EUR
		201-027	27,0	Sechskant	1	64,60 EUR
		201-030	30,0	Sechskant	1	91,00 EUR
		201-032	32,0	Sechskant	1	114,60 EUR
		201-013	13,0	Sechskant	20	8,26 EUR
		201-012	12,0	Sechskant	25	6,40 EUR
		201-011	11,0	Sechskant	25	5,04 EUR
		201-002	2,0	Sechskant	50	0,56 EUR
		201-205	2,5	Sechskant	50	0,56 EUR
		201-003	3,0	Sechskant	50	0,56 EUR
		201-305	3,5	Sechskant	50	0,56 EUR
		201-004	4,0	Sechskant	50	0,70 EUR
		201-405	4,5	Sechskant	50	0,98 EUR
		201-005	5,0	Sechskant	50	0,98 EUR
		201-505	5,5	Sechskant	50	0,98 EUR
		201-006	6,0	Sechskant	50	1,40 EUR
		201-007	7,0	Sechskant	50	2,20 EUR
		201-008	8,0	Sechskant	50	2,60 EUR
		201-009	9,0	Sechskant	25	3,00 EUR
		201-010	10,0	Sechskant	25	4,20 EUR
		201-036	36,0	Sechskant	1	161,80 EUR

Screws / drive > Screws / drive > Workshop stand

201/202	TU_WIN	Item number	SW 			Price
<p>The ISO 2936 sales and workshop stands are used for the tidy storage of offset screwdrivers. Hardness and torque comply with the ISO standard. The 201/202 series is inexpensive and compact and comes in numerous sizes suitable for various hexagon.</p> 		201-909	2,5; 3,0; 4,0; 5,0; 6,0; 8,0; 10,0; 12,0; 14,0 mm -	1,11 kg	1	47,00 EUR

204-000	TU_WIN	Item number	SW 	Profil		Price		
<p>The long offset screwdrivers of the 204 series are used for operating screw heads that are difficult to access. Hardness and torque comply with the ISO standard. The 204 series is inexpensive and compact.</p> 		204-105	1,5	Sechskant	50	0,70 EUR		
		204-010	10	Sechskant	50	7,28 EUR		
		204-011	11	Sechskant	20	10,00 EUR		
		204-012	12	Sechskant	20	10,92 EUR		
		204-013	13	Sechskant	20	14,56 EUR		
		204-014	14	Sechskant	20	18,00 EUR		
		204-017	17	Sechskant	5	28,60 EUR		
		204-019	19	Sechskant	5	42,80 EUR		
		204-022	22	Sechskant	5	63,80 EUR		
		204-024	24	Sechskant	1	92,40 EUR		
		204-009	9	Sechskant	50	5,80 EUR		
		204-008	8	Sechskant	50	4,20 EUR		
		204-007	7	Sechskant	50	3,00 EUR		
		204-002	2	Sechskant	50	0,70 EUR		
		204-205	2,5	Sechskant	50	0,98 EUR		
		204-003	3	Sechskant	50	0,98 EUR		
		204-305	3,5	Sechskant	50	1,40 EUR		
		204-004	4	Sechskant	50	1,60 EUR		
		204-405	4,5	Sechskant	50	2,20 EUR		
		204-005	5	Sechskant	50	2,20 EUR		
		204-505	5,5	Sechskant	50	2,60 EUR		
		204-006	6	Sechskant	50	2,60 EUR		
		204-027	27	Sechskant	1	145,00 EUR		
		204-808	TU_WIN	Item number	SW 	Profil		Price
		<p>The angled screwdriver sets of the 204 series are used for operating screw heads that are difficult to access in the workshop, industry and trade. Hardness and torque comply with the ISO standard. The 204 series is inexpensive and compact.</p> 		204-808	2,0; 3,0; 4,0; 5,0; 6,0; 8,0; 10,0	Sechskant	10	22,60 EUR
		204-809	TU_WIN	Item number	SW 		Profil	Price
		<p>The angled screwdriver sets of the 204 series are used for operating screw heads that are difficult to access in the workshop, industry and trade. Hardness and torque comply with the ISO standard. The 204 series is inexpensive and compact.</p> 		204-809	5/64; 3/32; 1/8; 5/32; 3/16; 1/4; 5/16; 3/8	10	Sechskant	22,60 EUR

204-900	TU_WIN	Item number	SW 			Price
<p>The sales and workshop stands ISO 2936 long of the series 204 are used for the tidy storage of offset screwdrivers in workshops, industry and trade. Hardness and torque correspond to the ISO standard. The 204 series is inexpensive and compact.</p> 		204-909	2,5; 3,0; 4,0; 5,0; 6,0; 8,0; 10,0; 12,0; 14,0 mm -	1,59 kg	1	68,00 EUR
		204-990	- 3/32; 1/8; 5/32; 3/16; 1/4; 5/16; 3/8; 1/2; 9/16 inch	1,19 kg	1	71,80 EUR
205-000	TU_WIN	Item number	SW 	Profil		Price
<p>The offset screwdrivers with ISO 6911 tang of the 205 series are used for operating special screw heads that are difficult to access. Hardness and torque comply with the ISO standard. The 205 series is inexpensive and compact and is available in a wide range of sizes to suit different hexagon heads.</p> 		205-003	3	Sechskant	100	1,40 EUR
		205-004	4	Sechskant	100	1,40 EUR
		205-005	5	Sechskant	100	1,40 EUR
		205-006	6	Sechskant	100	2,38 EUR
		205-007	7	Sechskant	50	3,00 EUR
		205-008	8	Sechskant	50	3,00 EUR
		205-010	10	Sechskant	25	4,62 EUR
		205-012	12	Sechskant	25	8,26 EUR
		205-014	14	Sechskant	20	13,72 EUR
		205-017	17	Sechskant	10	22,00 EUR
		205-019	19	Sechskant	10	32,40 EUR
		205-022	22	Sechskant	1	49,00 EUR
205-100	TU_WIN	Item number	SW 	Profil		Price
<p>The manual folding holders of the 205 series are used for operating screw heads that are difficult to access in the workshop, industry and trade. Hardness and torque comply with the ISO standard. The 205 series is inexpensive and compact and is available in numerous sizes suitable for different hexagon.</p> 		205-101	1,5; 2,0; 2,5; 3,0; 4,0; 5,0; 6,0	Sechskant	10	21,60 EUR
		205-102	2,5; 3,0; 4,0; 5,0; 6,0; 8,0	Sechskant	10	24,80 EUR
		205-103	3,0; 4,0; 5,0; 6,0; 8,0; 10,0	Sechskant	10	28,60 EUR
		205-104	2,5; 3,0; 4,0; 5,0; 6,0; 8,0; 10,0	Sechskant	10	30,00 EUR
		205-202	2,5; 3,0; 4,0; 5,0; 6,0; 8,0	Sechskant	10	26,40 EUR
		205-204	2,5; 3,0; 4,0; 5,0; 6,0; 8,0; 10,0	Sechskant	10	32,40 EUR













205-109	TU_WIN	Item number	SW 	Profil		Price
<p>The manual folding holders of the 205 series are used for operating screw heads that are difficult to access in the workshop, industry and trade. Hardness and torque comply with the ISO standard. The 205 series is inexpensive and compact and is available in numerous sizes suitable for different hexagon.</p>		205-109	2,5; 3; 4; 5; 6; 8; 10	Sechskant	10	32,40 EUR

Pulling > External > Heavy-duty fishplate puller with oscillating and height-adjustable puller legs

205	Ku-STA	Item number	 min. - max.	 max.		Price
<p>The heavy, 2-jaw puller with adjustable reach with oscillating and height-adjustable puller legs is used for the centric removal of large bearings, gears and discs in all common sizes. It can be used to remove components that sit on shafts and are freely accessible from the outside.</p>		205-00	0 mm - 100 mm	100 mm	1	70,60 EUR
		205-01	0 mm - 150 mm	150 mm	1	98,00 EUR
		205-02	0 mm - 250 mm	220 mm	1	162,80 EUR
		205-1	1 mm - 300 mm	280 mm	1	324,60 EUR
		205-2	0 mm - 400 mm	400 mm	1	439,40 EUR
		205-3	0 mm - 500 mm	540 mm	1	553,20 EUR





















205-P	KU-STA	Item number				Price
<p>The pair of puller legs with adjustable clamping depth is suitable for 2-arm universal pullers with swivelling puller hooks and adjustable clamping depth of the 205 series. The robust puller hooks guarantee particularly safe pulling off of bearings, gears and pulleys.</p>		205-00-100-P	205-00	0,24 kg	1	60,00 EUR
		205-01-150-P	205-01	0,6 kg	1	80,00 EUR
		205-02-220-P	205-02-B, 205-1-B, 205-02	1,38 kg	1	120,00 EUR
		205-1-280-P	205-1-B, 205-1	2,915 kg	1	200,00 EUR
		205-2-400-P	205-2-B, 208-2-B, 205-2	3,475 kg	1	320,00 EUR
		205-3-540-P	205-3, 205-3-B	5,85 kg	1	336,42 EUR



205-B	Ku-STA	Item number	 min. - max.	 max.		Price
<p>The heavy, 2-jaw puller with adjustable reach with oscillating, height-adjustable puller legs and grease-hydraulic spindle is used for the centric removal of large, particularly tight-fitting bearings, gears and discs. It can be used to remove components that are freely accessible from the outside.</p>		205-02-B	0 mm - 250 mm	220 mm	1	538,00 EUR
		205-1-B	1 mm - 300 mm	280 mm	1	751,40 EUR
		205-2-B	0 mm - 400 mm	400 mm	1	872,80 EUR
		205-3-B	0 mm - 500 mm	540 mm	1	1.077,40 EUR

















206	Ku-STA	Item number	 min. - max.	 max.		Price
<p>The heavy-duty, 3-arm puller with oscillating and height-adjustable puller legs is used for the centric removal of large bearings, gears and discs in all standard sizes. It can be used to remove components that sit on shafts and are freely accessible from the outside.</p>		206-00	0 mm - 100 mm	100 mm	1	95,00 EUR
		206-01	0 mm - 150 mm	150 mm	1	126,20 EUR
		206-02	0 mm - 250 mm	220 mm	1	211,80 EUR
		206-1	1 mm - 300 mm	280 mm	1	401,00 EUR
		206-2	0 mm - 450 mm	400 mm	1	538,00 EUR
		206-3	0 mm - 500 mm	540 mm	1	691,80 EUR
206-S	KU-STA	Item number				Price
<p>The set of puller legs with adjustable clamping depth is suitable for 3-arm universal pullers with swivelling puller hooks and adjustable clamping depth of series 205. The robust puller hooks guarantee particularly safe pulling off of bearings, gears and pulleys.</p>		206-00-100-S	206-00, 207-00	0,36 kg	1	60,00 EUR
		206-01-150-S	206-01, 207-01	0,88 kg	1	120,00 EUR
		206-02-220-S	Y08-208, 207-02-B, Y05-208, 206-02, 206-02-B, 207-02	2,205 kg	1	160,00 EUR
		206-1-280-S	207-1-B, 206-1, 206-1-B, 207-1	4,745 kg	1	320,00 EUR
		206-2-400-S	207-2-B, 209-2-B, 206-2, 206-2-B, 207-2	5,635 kg	1	520,00 EUR
		206-3-540-S	Y18-208, 207-3-B, Y10-208, 206-3, 206-3-B, 207-3	8,48 kg	1	760,00 EUR
206-B	Ku-STA	Item number	 min. - max.	 max.		Price
<p>The heavy-duty, 3-arm puller with oscillating, height-adjustable puller legs and grease-hydraulic spindle is used for the centric removal of large, particularly tight-fitting bearings, gears and discs. It can be used to remove components that are freely accessible from the outside.</p>		206-02-B	0 mm - 250 mm	220 mm	1	585,00 EUR
		206-1-B	1 mm - 300 mm	280 mm	1	827,40 EUR
		206-2-B	0 mm - 450 mm	400 mm	1	952,00 EUR
		206-3-B	0 mm - 500 mm	540 mm	1	1.216,00 EUR

207	Ku-STA	Item number	 min. - max.	 max.		Price
<p>The heavy-duty, 3-arm puller with oscillating, height-adjustable puller legs and combination crosshead is used for the centric removal of large bearings, gears and discs. It can be used to remove any component that sits on a shaft and is freely accessible from the outside.</p>		207-00	0 mm - 120 mm	100 mm	1	99,00 EUR
		207-01	0 mm - 200 mm	150 mm	1	133,60 EUR
		207-02	0 mm - 300 mm	220 mm	1	222,20 EUR
		207-1	1 mm - 400 mm	280 mm	1	473,00 EUR
		207-2	0 mm - 450 mm	400 mm	1	574,80 EUR
		207-3	0 mm - 550 mm	540 mm	1	770,40 EUR
207-B	Ku-STA	Item number	 min. - max.	 max.		Price
<p>The heavy-duty, 3-arm puller with oscillating, height-adjustable puller legs, combination crosshead and grease-hydraulic spindle is used for the centric removal of large, particularly tight bearings and discs. It can be used to loosen components that are freely accessible from the outside.</p>		207-02-B	0 mm - 300 mm	170 mm	1	595,80 EUR
		207-1-B	1 mm - 400 mm	230 mm	1	896,20 EUR
		207-2-B	0 mm - 450 mm	350 mm	1	995,60 EUR
		207-3-B	0 mm - 550 mm	490 mm	1	1.237,20 EUR
207-000	TU_WIN	Item number	 SW	Profil		Price
<p>The offset screwdriver sets ISO 2936 of series 207 are used for operating screw heads that are difficult to access. Hardness and torque comply with the ISO standard. The 207 series is inexpensive and compact, and housed in a lockable, impact-resistant plastic case.</p>		207-008	2,0; 2,5; 3,0; 4,0; 5,0; 6,0; 8,0; 10,0	Sechskant	10	19,60 EUR
		207-010	5/64; 3/32; 1/8; 5/32; 3/16; 1/4; 5/16; 3/8 inch	Sechskant	10	19,60 EUR
		207-011	2; 2,5; 3; 4; 5; 6; 8; 10	Sechskant	1	41,60 EUR
		207-012	5/64; 3/32; 1/8; 5/32; 3/16; 1/4; 5/16; 3/8 inch	Sechskant	10	41,60 EUR



Pulling > External > Economy" puller with oscillating and height-adjustable puller legs

208	Ku-STA	Item number	 min. - max.	 max.		Price
<p>The 2-armed lug puller "Economy" with oscillating and height-adjustable puller legs is used for pulling off bearings, gears and washers in all common sizes. The puller legs can be used universally due to the possibility of adjusting the clamping depth as well as the clamping width.</p> 		208-01	0 mm - 170 mm	95 mm	1	116,40 EUR
		208-02	0 mm - 230 mm	150 mm	1	156,60 EUR
		208-0	12 mm - 100 mm	50 mm	1	57,60 EUR
		208-2-B	64 mm - 400 mm	225 mm	1	789,80 EUR
208-P	KU-STA	Item number				Price
<p>The pair of pullers is suitable for 2-arm universal pullers of the 208 series. The robust pullers guarantee particularly safe pulling of bearings, gears and pulleys.</p> 		208-0-100-P	208-0	0,077 kg	1	60,00 EUR
		208-01-125-P	208-01	0,525 kg	1	80,00 EUR
		208-02-190-P	208-02	0,12 kg	1	80,00 EUR
209	Ku-STA	Item number	 min. - max.	 max.		Price
<p>The 3-armed lug puller "Economy" with oscillating and height-adjustable puller legs is used for pulling off bearings, gears and washers in all common sizes. The puller legs can be used universally due to the possibility of adjusting the clamping depth as well as the clamping width.</p> 		209-01	0 mm - 170 mm	95 mm	1	137,40 EUR
		209-02	160 mm - 230 mm	150 mm	1	204,20 EUR
		209-0	12 mm - 100 mm	50 mm	1	78,60 EUR
		209-2-B	64 mm - 450 mm	400 mm	1	1.273,80 EUR
209-S	KU-STA	Item number				Price
<p>The set of three standard pullers is suitable for 3-arm universal pullers. The robust pullers guarantee particularly safe pulling of bearings, gears and discs.</p> 		209-0-100-S	209-0	0,305 kg	1	80,00 EUR
		209-01-125-S	209-01	4 kg	1	120,00 EUR
		209-02-190-S	209-02	1,79 kg	1	120,00 EUR
209-T	KU-STA	Item number				Price
<p>The crosshead is a spare part for the 3-arm universal puller "Economy" with swivelling puller hook, adjustable clamping depth and long hydraulic spindle of the 209-2-B series.</p> 		209-2B-T	209-2-B	1,26 kg	1	160,00 EUR



24	Ku-STA	Item number				Price
<p>The Series 24 ball bearing puller and extractor sets are used for extracting bearings, gears, discs and internal bearings, bearing outer rings and bushes during repairs and maintenance. The set includes internal extractors, counter stays, extractor chucks and external extractors.</p> 	24-A	20-1, 43-1, 22-1, 22-2, 21-1, 21-2, 21-3, 21-4, 21-5, 21-6, 23	17,5 kg	1	1.613,80 EUR	
	24-B	20-1, 20-2, 22-1, 22-2, 21-1, 21-2, 21-3, 21-4, 21-5, 21-6, 21-7, 21-8, 23, 43-1	18 kg	1	2.360,00 EUR	
	24-C	20-1, 20-2, 43-1, 22-1, 22-2, 22-4, 21-1, 21-2, 21-3, 21-4, 21-5, 21-6, 21-7, 21-89, 23	23,98 kg	1	3.077,40 EUR	
25	Ku-STA	Item number				Price
<p>The ball bearing extractor sets of series 25 are used for extracting internal bearings, bearing outer rings and bushes. The multi-shell design of the internal extractors with their extra large gripping edges and the counter supports allow the safe extraction of internal parts.</p> 	25-A	22-1, 22-2, 21-1, 21-2, 21-3, 21-4, 21-5, 21-6	6,5 kg	1	1.007,20 EUR	
	25-B	22-1, 22-2, 21-1, 21-2, 21-3, 21-4, 21-5, 21-6, 21-7, 21-8	9,94 kg	1	1.418,40 EUR	
	25-C	22-1, 22-2, 22-4, 21-1, 21-2, 21-3, 21-4, 21-5, 21-6, 21-7, 21-89	17,5 kg	1	2.085,80 EUR	
	25-D	22-4, 21-89	9,275 kg	1	955,00 EUR	
	25-K	22-1, 21-00, 21-02, 21-2	2,165 kg	1	507,40 EUR	
K-26	Ku-STA	Item number				Price
<p>The ball bearing extractor sets of the K-26 series are used for extracting internal bearings, bearing outer rings and bushes. The 2-shell design of the internal extractors with their extra large gripping edges allows safe extraction of internal parts.</p> 	K-26-A	21-00, 21-02, 21-2, 21-4, 22-0-05, G-22, 699915	2,83 kg	1	490,00 EUR	
	K-26-B	22-0-09, 21-5, 21-6, 21-7, 21-8, 699915, G-22	8,435 kg	1	747,20 EUR	









26-B	Ku-STA	Item number				Price
<p>The internal extractor sets for impact actuation of series 26-B are used for extracting internal bearings, bearing outer rings and bushes. The 2-shell design of the internal extractors with their extra large gripping edges allows safe extraction of internal parts.</p>		26-B NEW	22-0-17, GA10-151 6, GA7-10, 21-1, 21-2, 21-3, 21-4, 21-5, 699915	4,74 kg	1	907,80 EUR
27-A	Ku-STA	Item number				Price
<p>The universal extractor set of series 27-A is used for extracting, separating and internally extracting bearings, gears, washers, etc.. The set is versatile for external extraction, internal extraction and internal extraction with engagement in the ball bearing.</p>		27-A	204-0, 21-0-E, 21-00-E, 21-01-E, 21-1-E, 21-2-E, 21-3-E, 21-4-E, 21-5-E, 43-001, 22-0-09	7,255 kg	1	1.587,20 EUR
28-A/B	Ku-STA	Item number				Price
<p>The slide hammer sets for extracting ball bearings and dowel pins of the 28 series are used for non-contact extraction of internal bearings, bearing outer rings and bushes as well as components with threads. Sliding hammer and thread inserts are included in the set for the application.</p>		28-A	21-00, 21-01, 21-02, 21-1, 21-2, 22-0-09	3,395 kg	1	673,20 EUR
		28-B	22-0-17, 21-1, 21-2, 21-3, 21-4, 21-5	6,145 kg	1	832,60 EUR
28-C/D	Ku-STA	Item number				Price
<p>The slide hammer sets for extracting ball bearings and dowel pins of the 28 series are used for non-contact extraction of internal bearings, bearing outer rings and bushes as well as components with threads. For the application, counter support, slide hammer and thread inserts are included in the set.</p>		28-C	25-A, 21-1, 21-2, 21-3, 21-4, 21-5, 21-6, 22-1, 22-2, 22-0-09	11,995 kg	1	1.395,60 EUR
		28-D	25-B, 21-1, 21-2, 21-3, 21-4, 21-5, 21-6, 21-7, 21-8, 22-1, 22-2	14,57 kg	1	1.766,80 EUR

K-22	KU-STA	Item number				Price	
<p>The ball bearing extractor sets with counter support and slide hammer are used for extracting internal bearings, bearing outer rings and bushes. The multi-shell design of the internal extractors with their extra large gripping edges allows safe extraction of internal parts.</p>		K-22-A		21-00, 21-02, 21-2, 21-4, 22-0-05, G-22, 22-1	4,1 kg	1	589,82 EUR
		K-22-B		21-5, 21-6, 21-7, 21-8, 22-0-09, 22-2, G-22	10,14 kg	1	903,00 EUR
K-22-A-M	Ku-STA	Item number				Price	
<p>The ball bearing extraction set with counter support and slide hammer are used for extracting internal bearings, bearing outer rings and bushes. The five sizes of the K-22-A-M series are specially adapted to the dismantling of common bearings, bearing outer rings and bushes in the automotive sector.</p>		K-22-A-M		22-0-10, 22-1, 21-01, 21-1, 21-2, 21-4, 21-5, 699915	4,1 kg	1	625,24 EUR
21	Ku-STA	Item number				Price	
<p>Series 21 internal extractors are used for extracting internal bearings, bearing outer rings and bushes. The multi-shell design of the internal extractors enables the safe extraction of internal parts. Depending on requirements, there are numerous variants of the 2- or 3-shell internal extractors.</p>	<p>21-0 21-1 21-7 21-89 21-00 21-2 21-8 21-90 21-01 21-3 21-9 21-02 21-4 21-5 21-6</p>	21-0		12 mm	22-0-05, 22-1	1	105,60 EUR
		21-00		12 mm	22-0-05, 22-1	1	105,60 EUR
		21-01		13 mm	22-0-05, 22-1	1	105,60 EUR
		21-02		15 mm	22-0-05, 22-1	1	105,60 EUR
		21-1		25 mm	22-0-05, 22-1	1	105,60 EUR
		21-2		27 mm	22-0-05, 22-1	1	105,60 EUR
		21-3		35 mm	22-0-05, 22-0-17, 22-1, 22-2	1	105,60 EUR
		21-4		40 mm	22-0-05, 22-0-17, 22-1, 22-2	1	105,60 EUR
		21-5		28 mm	22-0-05, 22-0-17, 22-1, 22-2	1	118,40 EUR
		21-6		48 mm	22-0-17, 22-2, 22-3	1	132,40 EUR
		21-7		100 mm	22-0-17, 22-2, 22-3	1	177,20 EUR
		21-8		100 mm	22-0-17, 22-2, 22-3	1	223,40 EUR
		21-89		120 mm	22-0-50, 22-4	1	513,20 EUR
		21-9		130 mm	22-0-17, 22-3	1	354,40 EUR
21-90		175 mm	22-0-50, 22-5	1	670,80 EUR		

28-A/B	KU-STA	Item number				Price
<p>The slide hammer sets for extracting ball bearings and dowel pins of the 28 series are used for non-contact extraction of internal bearings, bearing outer rings and bushes as well as components with threads. Sliding hammer and thread inserts are included in the set for the application.</p> 		28-A	21-00, 21-01, 21-02, 21-1, 21-2, 22-0-09	3,395 kg	1	673,20 EUR
		28-B	22-0-17, 21-1, 21-2, 21-3, 21-4, 21-5	6,145 kg	1	832,60 EUR
21-6	KU-STA	Item number				Price
<p>The spreading spindles are spare parts for the large internal extractors 21-89 and 21-90. The spindle is used to spread the spreading jaws during internal extraction.</p> 		21-89-6	21-89	0,49 kg	1	160,00 EUR
		21-90-6	21-90	1,145 kg	1	120,00 EUR



Spare parts > Spare parts > Pull-out trays

021089	KU-STA	Item number				Price
<p>The set of three extractor trays is a spare part of the internal extractor 21-89. The extractor trays are capable of safely extracting internal parts.</p> 		021089	21-89	1,38 kg	1	320,00 EUR
021090	KU-STA	Item number				Price
<p>The set of three extractor trays is a spare part of the internal extractor 21-90. The extractor trays are capable of safely extracting internal parts.</p> 		021090	21-90	3,19 kg	1	520,00 EUR

K-22-E	Ku-STA	Item number	  	Price		
<p>The ball bearing extraction sets with counter support and slide hammer of the K-22 series are used for extracting bearings, bearing outer rings and bushes that lie flat. The segmented design with extra fine gripping edges allows the safe extraction of flat lying parts.</p> 		K-22-A-E	22-0-05, 22-1, 21-0-E, 21-00-E, 21-01-E, 21-1-E	2,8 kg	1	586,20 EUR
		K-22-B-E	22-0-05, 22-1, 21-1-E, 21-2-E, 21-3-E, 21-4-E	3,255 kg	1	595,20 EUR
		K-22-C-E	22-0-05, 22-1, 21-0-E, 21-00-E, 21-01-E, 21-1-E, 21-2-E, 21-3-E, 21-4-E	3,405 kg	1	881,00 EUR
21-E	Ku-STA	Item number	  	Price		
<p>The segmented internal extractors are used to extract flat bearings, bearing outer rings, bushes and seals. The segmented design with extra-fine gripping edges enables safe extraction. Depending on the application, there are numerous variants of the segmented internal extractors.</p>  <p>21-0-E 21-1-E 21-5-E 21-00-E 21-2-E 21-6-E 21-01-E 21-3-E 21-7-E 21-4-E</p>		21-0-E	30 mm	22-0-05, 22-0-17, 22-1, 22-2	1	105,60 EUR
		21-00-E	30 mm	22-0-05, 22-0-17, 22-1, 22-2	1	105,60 EUR
		21-01-E	30 mm	22-0-05, 22-0-17, 22-1, 22-2	1	105,60 EUR
		21-1-E	35 mm	22-0-05, 22-0-17, 22-1, 22-2	1	105,60 EUR
		21-2-E	38 mm	22-0-05, 22-0-17, 22-1, 22-2	1	105,60 EUR
		21-3-E	45 mm	22-0-05, 22-0-17, 22-1, 22-2	1	105,60 EUR
		21-4-E	55 mm	22-0-05, 22-0-17, 22-1, 22-2	1	105,60 EUR
		21-44-E	45 mm	22-0-05, 22-0-17, 22-1, 22-2	1	138,60 EUR
		21-5-E	73 mm	22-0-17, 22-2	1	118,20 EUR
		21-6-E	80 mm	22-0-17, 22-2	1	132,40 EUR
		21-7-E	82 mm	22-0-17, 22-2	1	177,20 EUR

27-A	Ku-STA	Item number				Price
<p>The universal extractor set of series 27-A is used for extracting, separating and internally extracting bearings, gears, washers, etc.. The set is versatile for external extraction, internal extraction and internal extraction with engagement in the ball bearing.</p> 	27-A	204-0, 21-0-E, 21-00-E, 21-01-E, 21-1-E, 21-2-E, 21-3-E, 21-4-E, 21-5-E, 43-001, 22-0-09	7,255 kg	1	1.587,20 EUR	

Optional extensions > Accessories > Accessories for internal extractors

21-V-0	Ku-STA	Item number				Price
<p>The set of extensions for internal extractors of series 21 is used for loosening and extracting deep-seated bearings, bearing outer rings and bushes. The extensions, available in various lengths, allow variable use of the internal extractors even in extreme cases.</p> 	21-V-0	40; 60; 80; 100 mm	21-V-040, 21-V-060, 21-V-080, 21-V-310	1	211,80 EUR	
21-V	Ku-STA	Item number				Price
<p>The extensions for internal extractors of series 21 are used for loosening and extracting deep-seated bearings, bearing outer rings and bushes. The extensions, available in different lengths from 40 to 280 mm, allow variable use of the internal extractors even in extreme cases</p> 	21-V-040	40 mm	21-0, 21-00, 21-01, 21-02, 21-2	1	45,00 EUR	
	21-V-060	60 mm	21-0, 21-00, 21-01, 21-02, 21-2	1	64,68 EUR	
	21-V-080	80 mm	21-0, 21-00, 21-01, 21-02, 21-2	1	60,40 EUR	
	21-V-310	100 mm	21-3, 21-4, 21-5	1	73,00 EUR	

Pulling > Internal > Slide hammers





22-0	Ku-STA	Item number				Price
<p>The slide hammer devices of the 22-0 series are used together with internal extractors of the 21 series. The use of a slide hammer is recommended if no support surface is available or if it is too sensitive. The ergonomic sliding piece achieves a strong shock effect.</p> 	22-0-05	NEW	200 mm	0.5	1	106,60 EUR
	22-0-10	NEW	250 mm	0.9	1	145,40 EUR
	22-0-17	NEW	250 mm	1.7	1	292,00 EUR
	22-0-50	NEW	340 mm	5	1	421,96 EUR

K-22-E	Ku-STA	Item number				Price
<p>The ball bearing extraction sets with counter support and slide hammer of the K-22 series are used for extracting bearings, bearing outer rings and bushes that lie flat. The segmented design with extra fine gripping edges allows the safe extraction of flat lying parts.</p>		K-22-A-E	22-0-05, 22-1, 21-0-E, 21-00-E, 21-01-E, 21-1-E	2,8 kg	1	586,20 EUR
		K-22-B-E	22-0-05, 22-1, 21-1-E, 21-2-E, 21-3-E, 21-4-E	3,255 kg	1	595,20 EUR
		K-22-C-E	22-0-05, 22-1, 21-0-E, 21-00-E, 21-01-E, 21-1-E, 21-2-E, 21-3-E, 21-4-E	3,405 kg	1	881,00 EUR
22-0-2-100	Ku-STA	Item number				Price
<p>The additional weights of the 22-0-2-100 series are used together with slide hammers of the 22-0-500 series. Each additional weight module increases the impact weight of the slide hammer by 3 kg, which means that even particularly stuck parts can be removed safely and gently.</p>		22-0-2-100 NEW	3,225 kg	22-0-50	1	209,60 EUR
22-0-2-52	KU-STA	Item number				Price
<p>The nut is a spare part for the slide hammer device of the 22-0-2 series and is used to secure and fasten the adapter.</p>		22-0-2-52	229-1-2, 229-1	0,08 kg	1	40,00 EUR



Spare parts > Spare parts > Slide hammer





















22-01-G27-A	KU-STA	Item number				Price
<p>The slide hammer device is a spare part for the universal extractor set 27-A and enables internal extraction without existing support surfaces.</p>		22-01-G27-A	27-A	1,43 kg	1	160,00 EUR



G-22	Ku-STA	Item number				Price
<p>The 3-component handle as an accessory for slide hammers of the 22 series serves to provide better guidance during the extraction process when using slide hammers. The ergonomic handle design ensures a good feel and maximum power transmission even with wet and oily hands.</p>		G-22	155 mm	22-0-05, 22-0-17, 22-0-50	1	58,80 EUR

Pulling > Internal > Counter stays





22	Ku-STA	Item number			Price
<p>Counter stays from series 22 are used together with internal extractors from series 21. Counter stays are particularly suitable for large cylinder liners and ball bearings etc. thanks to the ribbed shape of the support feet and ensure a firm stand when extracting.</p> 	22-1	15 mm - 60 mm	21-3-E-C; 21-4-E-C; 21-0; 21-00; 21-01; 21-02; 21-1; 21-2; 21-3; 21-4; 21-5; 21-44-E; 21-0-E; 21-00-E; 21-01-E; 21-1-E; 21-2-E; 21-3-E; 21-4-E; 21-0-E-C; 21-00-E-C; 22-1-AS; 21-01-E-C; 21-1-E-C; 21-2-E-C	1	106,60 EUR
	22-2	25 mm - 100 mm	21-3-E-C; 21-4-E-C; 21-5-E-C; 21-6-E-C; 21-7-E-C; 21-3; 21-4; 21-5; 21-6; 21-7; 21-8; 21-44-E; 21-0-E; 21-00-E; 21-01-E; 21-1-E; 21-2-E; 21-3-E; 21-4-E; 21-5-E; 21-6-E; 21-7-E; 21-0-E-C; 21-00-E-C; 22-1-AS; 21-01-E-C; 21-1-E-C; 21-2-E-C	1	145,40 EUR
	22-3	0 mm - 180 mm	21-6; 21-7; 21-8; 21-9; 22-1-AS	1	292,00 EUR
	22-4	70 mm - 240 mm	21-89	1	350,80 EUR
	22-5	100 mm - 310 mm	21-90	1	394,80 EUR













25	Ku-STA	Item number				Price
<p>The ball bearing extractor sets of series 25 are used for extracting internal bearings, bearing outer rings and bushes. The multi-shell design of the internal extractors with their extra large gripping edges and the counter supports allow the safe extraction of internal parts.</p> 	25-A	22-1, 22-2, 21-1, 21-2, 21-3, 21-4, 21-5, 21-6	6,5 kg	1	1.007,20 EUR	
	25-B	22-1, 22-2, 21-1, 21-2, 21-3, 21-4, 21-5, 21-6, 21-7, 21-8	9,94 kg	1	1.418,40 EUR	
	25-C	22-1, 22-2, 22-4, 21-1, 21-2, 21-3, 21-4, 21-5, 21-6, 21-7, 21-89	17,5 kg	1	2.085,80 EUR	
	25-D	22-4, 21-89	9,275 kg	1	955,00 EUR	
	25-K	22-1, 21-00, 21-02, 21-2	2,165 kg	1	507,40 EUR	
	22-P	KU-STA	Item number			
<p>The pair of replacement hooks with fixing material is suitable for series 22 counter supports.</p> 	22-1-1-P	22-1	0,265 kg	1	60,00 EUR	
	22-2-1-P	22-2	0,54 kg	1	80,00 EUR	
	22-3-1-P	22-3	1,51 kg	1	120,00 EUR	
22-T	KU-STA	Item number				Price
<p>The crossbars are spare parts for series 22 counter supports.</p> 	22-1-T	22-1	0,19 kg	1	40,00 EUR	
	22-2-T	22-2	0,52 kg	1	60,00 EUR	
	22-3-T	22-3	1,155 kg	1	160,00 EUR	
	22-4-T	22-4	1,255 kg	1	200,00 EUR	
	22-5-T	22-5	3,27 kg	1	320,00 EUR	
022-006	KU-STA	Item number				Price
<p>The spindles are spare parts for series 22 counter-props. They are used to mount internal extractors on the prop.</p> 	022-106	22-1	0,205 kg	1	60,00 EUR	
	022-206	22-2	0,685 kg	1	80,00 EUR	
	022-306	22-3	1,085 kg	1	120,00 EUR	
	022506	22-5	1,81 kg	1	120,00 EUR	
	022406	22-4	0,89 kg	1	120,00 EUR	
022401	KU-STA	Item number				Price
<p>The support feet are spare parts for counter supports. Attached to the crossbar, the sturdy support feet provide a secure hold when pulling out inside.</p> 	022401	22-4	0,855 kg	1	80,00 EUR	
	022501	22-5	1,325 kg	1	120,00 EUR	













22-1-AS	Ku-STA	Item number				Price
The thread insert set for slide hammer or counter supports of the 22 series is used for extracting parts with centric threaded holes in crafts, industry and workshops. Six different threads for different situations and sizes are available in the set		22-1-AS	M4; M5; M6; M8; M10; M12	18-004A, 18-005A, 18-006A, 18-008A, 18-010A, 18-012A	1	86,20 EUR
29-A-69	Ku-STA	Item number				Price
The universal separator, extractor and ball bearing extractor set series 29-A-69 is used for easy extraction of bearings, drums, pulleys, pole wheels and similar parts on motorbikes and other small engines. The set is suitable for separating and removing ball bearings.		29-A-69	69-A, 225-150, 15-00	2,02 kg	1	532,60 EUR





Pulling > External > Cobra" puller with adjustable clamping depth and lateral clamping clamp

210	Ku-STA	Item number				Price
The 2-armed "Cobra" separating puller with adjustable clamping depth and lateral clamping clamp is used for removing flat bearings, gear rims and discs in all standard sizes. It can be used to remove any component that sits on a shaft and is freely accessible from the outside.		210-1	20 mm - 95 mm	170 mm	1	325,80 EUR
		210-2	20 mm - 135 mm	270 mm	1	405,80 EUR
		210-3	20 mm - 150 mm	325 mm	1	465,60 EUR
K-204-V-210-1	Ku-STA	Item number				Price
The universal puller set with side clamp is used for separating and pulling off flush or flat bearings, gear wheels etc. and front axles of VW. The puller legs of the pullers are partly reversible, adjustable in height and have standard and separating puller hooks.		K-204-V-210-1	204-V, 210-1, 225-150	5,305 kg	1	568,60 EUR
210-P	KU-STA	Item number				Price
The pair of puller hooks is suitable for 2-arm separator pullers "Cobra" of the 210 series. The puller hooks are reversible and can be used on both sides.		210-1-170-P	210-1	0,805 kg	1	200,00 EUR
		210-2-270-P	210-2	1,7 kg	1	200,00 EUR
		210-3-325-P	210-3	1,63 kg	1	320,00 EUR

210-000	TU_WIN	Item number	SW 	Profil		Price
<p>The multi-tooth offset screwdrivers for XZN DIN 65253 of the 210 series are used for operating special screw heads that are difficult to access. Hardness and torque correspond to the ISO standard. The series is inexpensive and compact and is available in numerous sizes suitable for various hexagon.</p> 		210-004	M 4	XZN Vielzahn	10	11,80 EUR
		210-005	M 5	XZN Vielzahn	10	8,68 EUR
		210-006	M 6	XZN Vielzahn	10	10,40 EUR
		210-008	M 8	XZN Vielzahn	10	14,00 EUR
		210-010	M10	XZN Vielzahn	10	18,60 EUR
		210-012	M 12	XZN Vielzahn	10	20,60 EUR
		210-014	M 14	XZN Vielzahn	10	30,00 EUR
		210-016	M 16	XZN Vielzahn	10	43,00 EUR
211-500	TU_WIN	Item number	SW 	Profil		Price
<p>The TX offset screwdrivers in the 211 series set are used for operating screw heads that are difficult to access. Unlike Allen keys, the Torx profile grips centrally, making work easier and reducing wear. The 211 series is inexpensive and compact.</p> 		211-504	9; 10; 15; 20; 25; 27; 30; 40	TORX®	10	39,40 EUR
		211-505	9; 10; 15; 20; 25; 27; 30; 40	TORX®	10	47,40 EUR
		211T505	9; 10; 15; 20; 25; 27; 30; 40	TORX®	10	63,60 EUR
211-TX	TU_WIN	Item number	SW 	Profil		Price
<p>The TX angled screwdrivers of the 211 series are used for operating screw heads that are difficult to access. Unlike Allen keys, the Torx profile grips in the centre, making work easier and reducing wear. The 211 series is inexpensive and compact.</p> 		211-506	TX 6	TORX®	10	4,40 EUR
		211-555	TX 55	TORX®	10	9,40 EUR
		211-550	TX 50	TORX®	10	6,80 EUR
		211-545	TX 45	TORX®	10	5,80 EUR
		211-540	TX 40	TORX®	10	5,80 EUR
		211-530	TX 30	TORX®	10	5,04 EUR
		211-527	TX 27	TORX®	10	4,62 EUR
		211-525	TX 25	TORX®	10	4,62 EUR
		211-520	TX 20	TORX®	10	4,62 EUR
		211-515	TX 15	TORX®	10	4,62 EUR
		211-510	TX 10	TORX®	10	4,40 EUR
		211-509	TX 9	TORX®	10	4,40 EUR
		211-508	TX 8	TORX®	10	4,40 EUR
		211-507	TX 7	TORX®	10	4,40 EUR
		211-560	TX 60	TORX®	10	12,60 EUR
211-TX-L	TU_WIN	Item number	SW 	Profil		Price
<p>The long TX angled screwdrivers of the 211 series are used for operating screw heads that are difficult to access. Unlike Allen keys, the Torx profile grips centrally, making work easier and reducing wear. The 211 series is inexpensive and compact.</p> 		211-609	TX 9	TORX®	10	5,80 EUR
		211-610	TX 10	TORX®	10	5,80 EUR
		211-615	TX 15	TORX®	10	5,80 EUR
		211-620	TX 20	TORX®	10	5,80 EUR
		211-625	TX 25	TORX®	10	6,40 EUR
		211-627	TX 27	TORX®	10	6,40 EUR
		211-630	TX 30	TORX®	10	6,80 EUR
		211-640	TX 40	TORX®	10	7,28 EUR

211	TU_WIN	Item number	SW 	Profil		Price
<p>The Tamper TX angled screwdrivers of the 211 series are used for operating screw heads that are difficult to access. Unlike Allen keys, the Torx profile grips centrally, making work easier and reducing wear. The 211 series is inexpensive and compact.</p> 		211T509	TX 9	TORX®	10	10,00 EUR
		211T510	TX 10	TORX®	10	10,00 EUR
		211T515	TX 15	TORX®	10	10,00 EUR
		211T520	TX 20	TORX®	10	10,00 EUR
		211T525	TX 25	TORX®	10	10,40 EUR
		211T527	TX 27	TORX®	10	10,40 EUR
		211T530	TX 30	TORX®	10	10,40 EUR
		211T540	TX 40	TORX®	10	11,80 EUR
212-TX	TU_WIN	Item number	SW 	Profil		Price
<p>The TX screwdrivers with T-handle of the 212 series are used for operating screw heads. Unlike hex keys, the Torx profile grips in the centre, making work easier and reducing wear. The 212 series is inexpensive and compact.</p> 		212-108	TX 8	TORX®	10	11,80 EUR
		212-245	TX 45	TORX®	10	24,80 EUR
		212-240	TX 40	TORX®	10	20,00 EUR
		212-230	TX 30	TORX®	10	18,60 EUR
		212-227	TX 27	TORX®	10	18,00 EUR
		212-225	TX 25	TORX®	10	17,00 EUR
		212-220	TX 20	TORX®	10	16,40 EUR
		212-215	TX 15	TORX®	10	14,56 EUR
		212-150	TX 50	TORX®	10	20,60 EUR
		212-145	TX 45	TORX®	10	18,00 EUR
		212-140	TX 40	TORX®	10	14,98 EUR
		212-130	TX 30	TORX®	10	14,00 EUR
		212-127	TX 27	TORX®	10	14,00 EUR
		212-125	TX 25	TORX®	10	14,00 EUR
		212-120	TX 20	TORX®	10	14,00 EUR
		212-115	TX 15	TORX®	10	13,00 EUR
		212-110	TX 10	TORX®	10	11,80 EUR
		212-109	TX 9	TORX®	10	11,80 EUR
212-250	TX 50	TORX®	10	29,00 EUR		
212	TU_WIN	Item number	SW 	Profil		Price
<p>The TX manual folding holders of the 212 series are used for operating screw heads that are difficult to access. Unlike Allen spanners, the Torx profile grips centrally and thus ensures easier working and less wear. The 212 series is inexpensive and compact.</p> 		212-258	9; 10; 15; 20; 25; 27; 30; 40	TORX®	10	49,60 EUR
		212-259	9; 10; 15; 20; 25; 27; 30; 40	TORX®	10	51,60 EUR
212-260	TU_WIN	Item number	SW 	Profil		Price
<p>The TX offset screwdrivers in the 212 series set are used for operating screw heads that are difficult to access. Unlike Allen keys, the Torx profile grips centrally, making work easier and reducing wear. The 212 series is inexpensive and compact.</p> 		212-260	9; 10; 15; 20; 25; 27; 30; 40	TORX®	5	82,60 EUR
		212-265	9; 10; 15; 20; 25; 27; 30; 40	TORX®	10	86,20 EUR
		212BT260	9; 10; 15; 20; 25; 27; 30; 40	TORX®	5	118,60 EUR

212-300	TU_WIN	Item number	SW 	Profil		Price
<p>The TX offset screwdrivers with ball end of the 212 series are used for operating screw heads that are difficult to access. Unlike Allen keys, the Torx profile grips centrally, making work easier and reducing wear. The 212 series is inexpensive and compact.</p> 		212-309	TX 9	TORX®	10	8,26 EUR
		212-310	TX 10	TORX®	10	9,40 EUR
		212-315	TX 15	TORX®	10	10,00 EUR
		212-320	TX 20	TORX®	10	10,00 EUR
		212-325	TX 25	TORX®	10	10,40 EUR
		212-327	TX 27	TORX®	10	10,92 EUR
		212-330	TX 30	TORX®	10	10,92 EUR
		212-340	TX 40	TORX®	10	13,60 EUR
		212-345	TX 45	TORX®	10	15,40 EUR
		212-350	TX 50	TORX®	10	16,40 EUR
		212-355	TX 55	TORX®	10	22,20 EUR
		212-360	TX 60	TORX®	10	28,00 EUR
212BT	TU_WIN	Item number	SW 	Profil		Price
<p>The colour-coded TX offset screwdrivers with ball end of the 212 series are used for operating screw heads that are difficult to access. Unlike Allen keys, the Torx profile grips in the centre, making work easier and reducing wear.</p> 		212BT309	TX 9	TORX®	10	13,60 EUR
		212BT310	TX 10	TORX®	10	14,00 EUR
		212BT315	TX 15	TORX®	10	14,56 EUR
		212BT320	TX 20	TORX®	10	14,98 EUR
		212BT325	TX 25	TORX®	10	15,40 EUR
		212BT327	TX 27	TORX®	10	16,00 EUR
		212BT330	TX 30	TORX®	10	16,00 EUR
		212BT340	TX 40	TORX®	10	18,00 EUR
213-000	TU_WIN	Item number	SW 	Profil		Price
<p>The long offset screwdrivers with ball head of the 213 series are used for operating screw heads that are difficult to access. Hardness and torque comply with the ISO standard. The 213 series is inexpensive and compact, and housed in a lockable, impact-resistant plastic case.</p> 		213-015	1,5	Sechskant	25	2,20 EUR
		213-002	2	Sechskant	25	2,20 EUR
		213-025	2,5	Sechskant	25	2,20 EUR
		213-003	3	Sechskant	25	2,20 EUR
		213-004	4	Sechskant	25	3,00 EUR
		213-005	5	Sechskant	25	3,00 EUR
		213-006	6	Sechskant	25	4,40 EUR
		213-007	7	Sechskant	10	7,28 EUR
		213-008	8	Sechskant	10	7,28 EUR
		213-010	10	Sechskant	10	10,00 EUR
		213-012	12	Sechskant	5	13,72 EUR
		213	TU_WIN	Item number	SW 	
<p>The long offset screwdrivers with ball head of the 213 series are used for operating screw heads that are difficult to access. Hardness and torque comply with the ISO standard. The 213 series is inexpensive and compact, and housed in a lockable, impact-resistant plastic case.</p> 		213-127	0,05	25	Sechskant	2,20 EUR
		213-953	3/8	10	Sechskant	10,00 EUR
		213-794	5/16	10	Sechskant	6,80 EUR
		213-635	1/4	25	Sechskant	4,20 EUR
		213-556	7/32	25	Sechskant	3,00 EUR
		213-476	3/16	25	Sechskant	3,00 EUR
		213-397	5/32	25	Sechskant	3,00 EUR
		213-357	9/64	25	Sechskant	2,20 EUR
		213-318	1/8	25	Sechskant	2,20 EUR
		213-277	7/64	25	Sechskant	2,20 EUR
		213-238	3/32	25	Sechskant	2,20 EUR
		213-198	5/64	25	Sechskant	2,20 EUR
		213-159	1/16	25	Sechskant	2,20 EUR
		213-960	1/2	10	Sechskant	19,60 EUR

213-990	TU_WIN	Item number	SW 	Profil		Price
<p>The long offset screwdrivers with ball end in the 213 series set are used for operating screw heads that are difficult to access. Hardness and torque comply with the ISO standard. They are inexpensive and compact, and housed in a lockable, impact-resistant plastic case.</p> 		213-990	2; 3; 4; 5; 6; 8; 10	Sechskant	10	56,80 EUR
213BT	TU_WIN	Item number	SW 	Profil		Price
<p>The long, colour-coded offset screwdrivers with ball head of the 213 series are used for operating screw heads that are difficult to access. Hardness and torque comply with the ISO standard. They are inexpensive and compact, and housed in an impact-resistant plastic case.</p> 		213BT015	1,5	Sechskant	25	5,80 EUR
		213BT002	2	Sechskant	25	5,80 EUR
		213BT025	2,5	Sechskant	25	5,80 EUR
		213BT003	3	Sechskant	25	5,80 EUR
		213BT004	4	Sechskant	25	6,60 EUR
		213BT005	5	Sechskant	25	7,60 EUR
		213BT006	6	Sechskant	25	10,40 EUR
		213BT008	8	Sechskant	10	14,00 EUR
		213BT010	10	Sechskant	10	17,60 EUR
214	TU_WIN	Item number	SW 	Profil		Price
<p>The short offset screwdrivers with ball end of the 214 series are used for operating screw heads that are difficult to access. Hardness and torque comply with the ISO standard. The 214 series is inexpensive and compact, and is housed in a lockable, impact-resistant plastic casing.</p> 		214-105	1,5	Sechskant	50	2,60 EUR
		214-002	2,0	Sechskant	50	2,20 EUR
		214-025	2,5	Sechskant	50	2,20 EUR
		214-003	3,0	Sechskant	50	2,20 EUR
		214-004	4,0	Sechskant	50	2,60 EUR
		214-005	5,0	Sechskant	50	3,00 EUR
		214-006	6,0	Sechskant	50	3,64 EUR
		214-007	7,0	Sechskant	25	5,80 EUR
		214-008	8,0	Sechskant	25	6,40 EUR
		214-010	10,0	Sechskant	25	7,60 EUR
		214-012	12,0	Sechskant	50	13,40 EUR
		214-200	TU_WIN	Item number	SW 	Profil
<p>The short offset screwdrivers with ball end in the set of series 214 are used for operating screw heads that are difficult to access. Hardness and torque comply with the ISO standard. They are inexpensive and compact, and housed in a lockable, impact-resistant plastic case.</p> 		214-200	2; 2,5; 3; 4; 5; 6; 8; 10	Sechskant	10	36,20 EUR

214-T	TU_WIN	Item number	SW 	Profil		Price
<p>The screwdrivers with ball head and T-handle of the 214 series are used for operating screw heads in workshops, industry and trade. Hardness and torque correspond to the ISO standard. The 214 series is inexpensive and compact.</p> 		214-310	3	Sechskant	10	5,80 EUR
		214-410	4	Sechskant	10	6,40 EUR
		214-415	4	Sechskant	10	6,80 EUR
		214-510	5	Sechskant	10	6,80 EUR
		214-515	5	Sechskant	10	7,60 EUR
		214-615	6	Sechskant	10	8,26 EUR
		214-620	6	Sechskant	10	8,40 EUR
		214-815	8	Sechskant	10	10,92 EUR
		214-820	8	Sechskant	10	11,80 EUR
	214-910	10	Sechskant	10	19,00 EUR	

215	TU_WIN	Item number	SW 	Profil		Price
<p>The right-angle screwdrivers with ball head in the KUKKO clip from the 215 series are used to operate screw heads that are difficult to access. Hardness and torque comply with the ISO standard. They are inexpensive and compact, and are housed in a lockable, impact-resistant plastic casing.</p> 		215-000	1,5; 2,0; 2,5; 3,0; 4,0; 5,0; 6,0; 8,0; 10,0	Sechskant	10	47,40 EUR
		215-001	0,05; 1/16; 5/64; 3/32; 1/8; 5/32; 3/16; 7/32; 1/4; 5/16 inch	Sechskant	10	58,20 EUR
		215-002	1,5; 2,0; 2,5; 3,0; 4,0; 5,0; 6,0; 8,0; 10,0	Sechskant	10	51,60 EUR
		215-003	1,5; 2,0; 2,5; 3,0; 4,0; 5,0; 6,0; 8,0; 10,0	Sechskant	20	36,60 EUR
		215BT004	1,5; 2,0; 2,5; 3,0; 4,0; 5,0; 6,0; 8,0; 10,0	Sechskant	10	79,80 EUR

Pulling > Internal > Universal ball bearing extractors





220	Ku-STA	Item number	 min. - max.	 max.		Price
<p>The universal puller with slide hammer is used to remove gears, ball bearings, bearing rings, sealing rings and other parts. The universal puller can be used not only for external extraction, but also for internal extraction and for removing parts with threaded holes.</p> 		220	0 mm - 130 mm	165 mm	1	721,20 EUR
		220-K	0 mm - 200 mm	165 mm	1	846,20 EUR

Storage / Presentation > Storage / Presentation > Blackboards





220-T	Ku-STA	Item number				Price
<p>The universal puller assortment is a wall panel equipped with matching tools for application and storage. With tools that can be used over a wide area, it is ideal for use in external stripping, stripping parts with threaded holes and internal stripping.</p>		220-T	220, 220-02, 220-03, 207-2, WT-000	21,18 kg	1	1.474,40 EUR





Pulling > External > Puller with conical self-clamping





220-02	Ku-STA	Item number				Price
<p>The 2- and 3-arm pullers with conical self-clamping are used to remove bearings, gears and discs in all standard sizes. They can be used to remove components that sit on shafts and are freely accessible from the outside. The clamping width is adjusted using the conical knurl.</p>		220-02	10 mm - 200 mm	165 mm	1	335,60 EUR
<p>The pair of pullers is suitable for 2-arm pullers with conical self-clamping of the 220 series.</p>		220-02-165-P				Price
			220, 220-K, 220-02	0,565 kg	1	120,00 EUR
<p>The 3-arm puller with conical self-clamping is used to remove bearings, gears and discs in all standard sizes. It can be used to remove any component that sits on a shaft and is freely accessible from the outside. The clamping width is adjusted using the conical knurl.</p>		220-03	10 mm - 200 mm	165 mm		Price
						389,80 EUR

220-S	KU-STA	Item number				Price
The set of puller legs is suitable for 3-arm pullers with conical self-clamping of the 220 series.		220-03-165-S	220, 220-K, 220-03	0 kg	1	160,00 EUR





Cutting / loosening > Cutting / loosening > Soft scraper

2200-ST	Ku-STA	Item number				Price
The soft scraper set is used to gently remove adhesive weights and seal residues, glued protective strips, badges as well as vignettes. Thanks to the polished scraper blade, even hard-to-remove adhesive residues disappear, while the polyoxymethylene manufacturing prevents surface damage.		2200	60; 80; 150; 150 mm	190; 210; 280; 280 mm	1	50,40 EUR





2200	KU-STA	Item number				Price
The soft scraper is used to gently remove adhesive weights and seal residues, glued protective strips, badges as well as vignettes. Thanks to the polished scraper blade, even hard-to-remove adhesive residues disappear, while the manufacture from polyoxymethylene prevents surface damage.		2200-1	22 - 60 mm	190 mm	1	12,60 EUR
		2200-2	22 - 80 mm	210 mm	1	12,60 EUR
		2200-3	22 - 150 mm	280 mm	1	12,60 EUR
		2200-4	28 - 150 mm	280 mm	1	12,60 EUR

221-G	Ku-STA	Item number				Price
The Series 221 internal extractors with slide hammer are used for removing and internally extracting ball bearings, roller bearings, inner rings and other flush-fitting parts. The internal extractor is a purpose-orientated model with a large clamping range.		221-G	490 mm	135 mm	1	525,60 EUR





Storage / Presentation > Suitcase > K-disassembly





K-222	Ku-STA	Item number				Price
The seal extraction set is used to extract Simmerrings®, radial shaft seals, sealing collars, gaskets, bearing seals and shaft seals. In addition to dismantling tools, a pick and a special screw set, the set also includes extensions and handles.		K-222-1/7	222-1, 222-U, 222-S, 222-1-100, 222-1-250, 222-1-50S, 222-E, 222-P	2,895 kg	1	407,80 EUR





Pulling > Removing > Seal ring disassembly





222-1	Ku-STA	Item number				Price
<p>The 222 series sealing ring removal tools are used to remove radial shaft seals, axial shaft seals, sealing collars and other bearing seals. The 222 series impresses with its wide range of applications for use in various problem situations.</p> 		222-1	430 mm	0,82 kg	1	85,00 EUR













Spare parts > Spare parts > Spare parts for K-222





















222-ET	KU-STA	Item number				Price
<p>The spare parts for the sealing ring extractor K-222 help with the universal use of the set. Extensions in various sizes, a set of 50 special screws, replacement blades and picks with 2K handles are available.</p> 		222-1-100	K-222-1/7	0,055 kg	1	40,00 EUR
		222-1-250	K-222-1/7	0,15 kg	1	40,00 EUR
		222-1-50S	K-222-1/7	0,155 kg	1	80,00 EUR
		222-E	K-222-1/7	0,045 kg	1	40,00 EUR
		222-P			0,04 kg	1





222	Ku-STA	Item number				Price
<p>The seal ring removal tools of the 222 series are used to remove radial shaft seals, axial shaft seals, sealing collars and other bearing seals. The extraction process can be carried out using the 222-U extraction lever or the 222-S slide hammer device.</p> 		222-U	300 mm	0,565 kg	1	82,60 EUR
		222-S	650 mm	1,265 kg	1	170,00 EUR

K-222	Ku-STA	Item number				Price
<p>The seal extraction set is used to extract Simmerrings®, radial shaft seals, sealing collars, gaskets, bearing seals and shaft seals. In addition to dismantling tools, a pick and a special screw set, the set also includes extensions and handles.</p> 		K-222-1/7	222-1, 222-U, 222-S, 222-1-100, 222-1-250, 222-1-50S , 222-E, 222-P	2,895 kg	1	407,80 EUR



KS-22	Ku-STA	Item number				Price
<p>The slide hammer sets in the KS-22 series case are used for extracting bushings as well as components with threads (dowel pins, keys, bolts, etc.). The use of a slide hammer is recommended especially when no support surface is available or when this is too sensitive.</p> 		KS-22-01	22-0-09	2,12 kg	1	226,80 EUR
		KS-22-02	22-0-09	2 kg	1	227,20 EUR
		KS-22-01-UNC	22-0-09		2,17 kg	1

K-22-UNC	Ku-STA	Item number				Price
<p>The slide hammer set in the case of the K-22 series is used for extracting parts with threaded holes (dowel pins, feather keys, etc.) with American thread dimensions. The threads included in the set can be screwed in using the corresponding Allen key, which is also included.</p>		K-22-01-UNC	22-0-09, G-22, 238-318, 238-397, 238-476, 238-556, 238-635	2,98 kg	1	370,40 EUR
<p>223-K</p>	Ku-STA	Item number				Price
<p>The feather key and dowel pin extractor set is used to extract bushings as well as components with threads (dowel pins, feather keys, bolts, etc.). In addition to a slide hammer device, various thread inserts are included to extract parts in different sizes.</p>		223-K	GE4-10, GE5-10, GE6-10, GE8-10, GE10-10, GE12-10, GE3-10, GE14-10, GE16-10, GE18-10	2,94 kg	1	348,20 EUR
		223-G	22-0-10, GA12-181 5, GE10-181 5, GE12-181 5, GE14-181 5, GE16-181 5, GE18-181 5, GE20-181 5, GE22-181 5, GE24-181 5, GE8-1815	5,085 kg	1	569,60 EUR
<p>223</p>	Ku-STA	Item number				Price
<p>The pullers in the 223 series are used to pull parts with centred threaded holes. The ergonomic sliding piece allows the force to be optimally transmitted and a strong shock effect to be achieved. This also ensures non-contact and gentle extraction.</p>		223	0.9	250 mm	1	218,00 EUR





28-A/B	Ku-STA	Item number				Price
<p>The slide hammer sets for extracting ball bearings and dowel pins of the 28 series are used for non-contact extraction of internal bearings, bearing outer rings and bushes as well as components with threads. Sliding hammer and thread inserts are included in the set for the application.</p>		28-A	21-00, 21-01, 21-02, 21-1, 21-2, 22-0-09	3,395 kg	1	673,20 EUR
		28-B	22-0-17, 21-1, 21-2, 21-3, 21-4, 21-5	6,145 kg	1	832,60 EUR
223-2	Ku-STA	Item number				Price
<p>The dowel pin extractor series 223-2 is used for dismantling dowel pins and dowel pins. The three jaws mounted in the chuck can be adjusted to the respective application in the range of 1-13 mm.</p>		223-2	0.9	265 mm	1	365,40 EUR
223-GH	Ku-STA	Item number				Price
<p>The slide hammer device is a spare part for the extractor for parts with threaded holes and enables internal extraction without existing support surfaces.</p>		223-GH	223	0,65 kg	1	50,40 EUR
224	Ku-STA	Item number				Price
<p>The 224 series internal extractors with slide hammer are used for extracting small spur and guide bearings, bearing rings and similar parts. The internal extractor is a purpose-orientated model with a large clamping range that enables bearings to be extracted gently and without contact.</p>		224-1	400 mm	38 mm	1	285,60 EUR
		224-2	400 mm	50 mm	1	267,20 EUR
224-121	Ku-STA	Item number				Price
<p>The internal extractors are spare parts for internal extractors with slide hammer of the 224 series. They are specially designed for them and intended for extracting small end and guide bearings, bearing rings and similar parts in crafts, industry and workshops.</p>		224-121	224-1	0,285 kg	1	200,00 EUR
		224-221	224-2	0,265 kg	1	200,00 EUR





224-GH	KU-STA	Item number				Price
The slide hammer device is a spare part for the internal extractor with slide hammer 224 and enables internal extraction without existing support surfaces.		224-GH	224-1, 224-2	1,5 kg	1	120,00 EUR





Pulling > External > Puller with self-centring puller legs, connected with a spring





















225-S	Ku-STA	Item number	max.			Price
The bolt extractor set with thread adapters of the 225 series is used for extracting bolts, e.g. brake shoe bolts or spring bolts on commercial vehicles. Included is a 7 kg impact hammer and a set of 7 different thread inserts to be prepared for any extraction situation.		225		11,02 kg	1	1.021,00 EUR









Spare parts > Spare parts > Thread adapter, /inserts, connecting nut

225-GA	KU-STA	Item number				Price
Thread adapters are spare parts that allow flexible connections between different threads and thus provide more flexible application possibilities.		225-3-A	225-3	0,035 kg	1	24,00 EUR
		225-2-A	225-2	0,035 kg	1	24,00 EUR









225-57-S	KU-STA	Item number				Price
The pins are spare parts for 3-arm pullers with self-centring puller hooks of the 225 and 225-SK series.		225-57-S	225-1, 225-2, 225-3, 225-SK	0,003 kg	1	60,00 EUR















225-0	Ku-STA	Item number	 min. - max.	 max.		Price
The 3-arm puller with self-centring puller legs is used to pull bearings, gears and discs. It can be used to remove components that sit on shafts and are freely accessible from the outside. Slipping is prevented thanks to the spring-loaded puller legs.		225-1	18,4 mm - 50 mm	35 mm	1	495,60 EUR
		225-2	58 mm - 90 mm	35 mm	1	495,60 EUR
		225-3	38 mm - 70 mm	35 mm	1	495,60 EUR











225-G	Ku-STA	Item number	 min. - max.	 max.		Price
<p>The 3-arm puller with self-centring puller legs and slide hammer is used to pull bearings, gears and discs. The slide hammer guarantees space-saving and gentle extraction. It can be used to remove components that are mounted on shafts and are freely accessible from the outside. Thanks to the spring-loaded puller legs, slipping is prevented.</p>		225-1-G	18,4 mm - 50 mm	35 mm	1	590,80 EUR
		225-2-G	58 mm - 90 mm	35 mm	1	590,80 EUR
		225-3-G	38 mm - 70 mm	35 mm	1	602,28 EUR
225-GE	KU-STA	Item number	 KOMBINIERBAR KOMBINABLE			Price
<p>The 7-piece thread insert set is used to produce internal threads for screwed connections. The inserts in different sizes expand the application in handicraft, industry and workshop.</p>		225-GE	225	0 kg	1	200,00 EUR
225-SK	Ku-STA	Item number	 min. - max.	 max.		Price
<p>The 3-arm puller with self-centring puller legs is used for the safe and damage-free removal of plugged hub caps, hubcaps and dust and grease caps. The puller legs are connected with a spring and thus prevent slipping during the removal process.</p>		225-SK	- 65 mm	24 mm	1	690,40 EUR
225-SK-G	Ku-STA	Item number	 min. - max.	 max.		Price
<p>The 3-arm puller with self-centring puller legs and slide hammer is used for the safe and damage-free removal of plugged hub caps, hub caps and dust and grease caps. The slide hammer guarantees space-saving and material-friendly extraction. The puller legs are connected with a spring and thus prevent slipping during the removal process.</p>		225-SK-G	- 65 mm	24 mm	1	781,56 EUR
K-226	Ku-STA	Item number				Price
<p>The puller for truck axles in the K-226 series case is used to pull off wheel hubs on SAF and BPW axles for trucks and commercial vehicles. In addition to pullers, an additional hydraulic press and several adapters are included, which enable use on most common models.</p>		K-226-4/12	9-2, 18-4	25,14 kg	1	1.765,60 EUR

226	Ku-STA	Item number				Price
<p>The puller for truck axles in the K-226 series case is used to pull off wheel hubs on SAF and BPW axles for trucks and commercial vehicles. In addition to pullers, an additional hydraulic press and several adapters are included, which enable use on most common models.</p> 		226-4/11			1	1.367,20 EUR
184015	KU-STA	Item number				Price
<p>The pair of pull bolts with nuts is a spare part for pullers for truck axles of the K-226 series. The pull bolts are used to pull off wheel hubs on SAF and BPW axles for trucks and commercial vehicles.</p> 		184015	K-226-4/1 2	2,4 kg	1	200,00 EUR

Pulling > Removing > Puller for shoulder bearing inner rings

23	Ku-STA	Item number				Price
<p>The extraction chuck of the 23 series is used for extracting shoulder bearing inner rings on alternators and electric motors. The extraction chuck convinces with its stability and ease of use, thus ensuring safe extraction.</p> 		23	5 mm - 32 mm	1,42 kg	1	236,40 EUR
24	Ku-STA	Item number				Price
<p>The Series 24 ball bearing puller and extractor sets are used for extracting bearings, gears, discs and internal bearings, bearing outer rings and bushes during repairs and maintenance. The set includes internal extractors, counter stays, extractor chucks and external extractors.</p> 		24-A	20-1, 43-1, 22-1, 22-2, 21-1, 21-2, 21-3, 21-4, 21-5, 21-6, 23	17,5 kg	1	1.613,80 EUR
		24-B	20-1, 20-2, 22-1, 22-2, 21-1, 21-2, 21-3, 21-4, 21-5, 21-6, 21-7, 21-8, 23, 43-1	18 kg	1	2.360,00 EUR
		24-C	20-1, 20-2, 43-1, 22-1, 22-2, 22-4, 21-1, 21-2, 21-3, 21-4, 21-5, 21-6, 21-7, 21-89, 23	23,98 kg	1	3.077,40 EUR

023002	KU-STA	Item number				Price
The hook set is suitable for extractor chucks for deep groove ball bearing inner rings of series 23.		023002	23	0,007 kg	1	120,00 EUR
230-I	Ku-STA	Item number				Price
The knock-out tool for injectors of the 230-I series is used to pull off injection nozzles of diesel engines in passenger cars. Due to the ergonomically shaped, solid sliding piece of the slide hammer, the applied force can be optimally transferred and a strong shock effect can be achieved.		230-I	280 mm	2,71 kg	1	358,60 EUR
222-230	TU_WIN	Item number		Profil		Price
The hexagon screwdrivers with T-handle of the 222-230 series are used for operating screw heads in workshops, industry and crafts. Hardness and torque correspond to the ISO standard. The 222-230 series is inexpensive and compact.		222-090	2	Sechskant	10	5,40 EUR
		230-100	10	Sechskant	10	14,56 EUR
		228-200	8	Sechskant	10	9,60 EUR
		228-150	8	Sechskant	10	8,40 EUR
		228-100	8	Sechskant	10	7,60 EUR
		226-200	6	Sechskant	10	7,60 EUR
		226-150	6	Sechskant	10	7,00 EUR
		226-100	6	Sechskant	10	6,80 EUR
		225-200	5	Sechskant	10	7,00 EUR
		225-150	5	Sechskant	10	6,80 EUR
		225-101	5	Sechskant	10	6,00 EUR
		224-200	4	Sechskant	10	6,40 EUR
		224-150	4	Sechskant	10	6,00 EUR
		224-100	4	Sechskant	10	5,00 EUR
		223-200	3	Sechskant	10	5,80 EUR
		223-150	3	Sechskant	10	5,00 EUR
223-121	3	Sechskant	10	4,40 EUR		
222-100	2,5	Sechskant	10	5,80 EUR		
230-200	10	Sechskant	10	17,40 EUR		
235	TU_WIN	Item number		Profil		Price
The hexagonal cross-handle screwdrivers with drive on both sides of the 235 series are used for operating screw heads at high torques. Hardness and torque comply with the ISO standard. The 235 series is ideal for use in demanding situations.		235-0210	2	Sechskant	1	10,92 EUR
		235-0251	2,5	Sechskant	1	11,80 EUR
		235-0310	3	Sechskant	1	11,80 EUR
		235-0415	4	Sechskant	1	12,60 EUR
		235-0515	5	Sechskant	1	13,60 EUR
		235-0620	6	Sechskant	1	14,56 EUR
		235-0820	8	Sechskant	1	17,00 EUR
		235-1020	10	Sechskant	1	27,00 EUR

236	TU_WIN	Item number	SW 	Profil		Price
<p>The hexagonal sockets with T-handle of the 236 series are used for operating screw heads in the workshop, industry and trade. Hardness and torque correspond to the ISO standard. The 236 series is inexpensive and compact.</p> 		236-050	5	Sechskant	6	18,00 EUR
		236-160	16	Sechskant	6	24,40 EUR
		236-150	15	Sechskant	6	23,60 EUR
		236-140	14	Sechskant	6	23,60 EUR
		236-130	13	Sechskant	1	23,20 EUR
		236-120	12	Sechskant	1	22,60 EUR
		236-110	11	Sechskant	6	20,00 EUR
		236-100	10	Sechskant	6	20,60 EUR
		236-090	9	Sechskant	6	19,00 EUR
		236-080	8	Sechskant	6	19,00 EUR
		236-070	7	Sechskant	6	18,60 EUR
		236-060	6	Sechskant	6	18,00 EUR
		236-055	5,5	Sechskant	6	18,00 EUR
		236-170	17	Sechskant	6	26,00 EUR
238/239	TU_WIN	Item number	SW 	Profil		Price
<p>The offset screwdrivers of the 238 & 239 series are used for operating screw heads that are difficult to access in the workshop, industry and trade. Hardness and torque comply with the ISO standard. The 238 & 239 series are inexpensive and compact.</p> 		238-119	3/64	100	Sechskant	0,56 EUR
		238-794	5/16	50	Sechskant	2,60 EUR
		238-873	11/32	50	Sechskant	3,00 EUR
		238-953	3/8	25	Sechskant	4,20 EUR
		239-111	7/16	25	Sechskant	5,04 EUR
		239-127	1/2	20	Sechskant	8,26 EUR
		239-143	9/16	20	Sechskant	10,00 EUR
		239-159	5/8	10	Sechskant	15,40 EUR
		239-190	3/4	10	Sechskant	23,60 EUR
		239-220	7/8	5	Sechskant	43,20 EUR
		238-714	9/32	50	Sechskant	2,20 EUR
		238-635	1/4	100	Sechskant	1,40 EUR
		238-556	7/32	100	Sechskant	0,98 EUR
		238-127	0,05	100	Sechskant	0,56 EUR
		238-159	1/16	100	Sechskant	0,56 EUR
		238-198	5/64	100	Sechskant	0,56 EUR
		238-238	3/32	100	Sechskant	0,56 EUR
		238-277	7/64	100	Sechskant	0,56 EUR
		238-318	1/8	100	Sechskant	0,56 EUR
		238-357	9/64	100	Sechskant	0,56 EUR
		238-397	5/32	100	Sechskant	0,56 EUR
		238-476	3/16	100	Sechskant	0,98 EUR
		239-254	1	1	Sechskant	80,20 EUR
K-22-UNC	TU_WIN	Item number				Price
<p>The slide hammer set in the case of the K-22 series is used for extracting parts with threaded holes (dowel pins, feather keys, etc.) with American thread dimensions. The threads included in the set can be screwed in using the corresponding Allen key, which is also included.</p> 		K-22-01-UNC	22-0-09, G-22, 238-318, 238-397, 238-476, 238-556, 238-635	2,98 kg	1	370,40 EUR





240/241/242	TU_WIN	Item number	SW 		Profil	Price
<p>The long offset screwdrivers of the 240, 241 & 242 series are used for operating hard-to-reach screw heads in workshops, industry and crafts. Hardness and torque comply with the ISO standard. The 240, 241 & 242 series are inexpensive and compact.</p> 		240-159	1/16	50	Sechskant	0,98 EUR
		240-873	11/32	25	Sechskant	5,80 EUR
		240-953	3/8	25	Sechskant	7,28 EUR
		241-111	7/16	10	Sechskant	10,00 EUR
		241-127	1/2	10	Sechskant	14,56 EUR
		241-429	9/16	10	Sechskant	18,60 EUR
		241-588	5/8	5	Sechskant	26,00 EUR
		241-905	3/4	5	Sechskant	43,00 EUR
		242-220	7/8	5	Sechskant	76,00 EUR
		240-794	5/16	25	Sechskant	4,20 EUR
		240-714	9/32	25	Sechskant	3,00 EUR
		240-198	5/64	50	Sechskant	0,98 EUR
		240-238	3/32	50	Sechskant	0,98 EUR
		240-318	1/8	50	Sechskant	0,98 EUR
		240-357	9/64	50	Sechskant	2,20 EUR
		240-397	5/32	50	Sechskant	2,20 EUR
		240-476	3/16	50	Sechskant	2,20 EUR
		240-556	7/32	50	Sechskant	2,60 EUR
		240-635	1/4	50	Sechskant	2,60 EUR
		242-540	1	1	Sechskant	138,60 EUR

Cutting / loosening > Cutting / loosening > Nozzle reamer set





245	TU_RES	Item number	∅	Stück pieces		Price
<p>The 13-piece nozzle reamer set is used for cleaning nozzles. The set consists of two tool holders and eleven reamers with different diameters ranging from 0.6 to 1.9 mm.</p> 		245-004	0,6; 0,65; 0,7; 0,75; 0,8; 0,9; 1,0; 1,1; 1,3; 1,5; 1,7; 1,9	12	5	63,40 EUR

Screws / drive > Screws / drive > Watchmaker's screwdriver













250-000	KU-STA	Item number		L 		Price
<p>The slotted watchmaker's screwdrivers of the 250 series are used for sensitive work for the highest demands in crafts and watchmaking. The screwdrivers with rotating hexagonal head and fluted fine screw handle allow the controlled transmission of strong torques.</p> 		250-010	1	80 mm	10	10,00 EUR
		250-012	1,2	84 mm	10	9,80 EUR
		250-014	1,4	84 mm	10	9,80 EUR
		250-015	1,5	84 mm	10	8,40 EUR
		250-020	2	100 mm	10	10,92 EUR
		250-025	2,5	100 mm	10	10,92 EUR
		250-029	2,9	112 mm	10	11,80 EUR
		250-030	3	112 mm	10	12,60 EUR
		250-035	3,5	112 mm	10	12,60 EUR









250-PH	KU-STA	Item number				Price	
<p>The Phillips watchmaker's screwdrivers of the 250 series are used for sensitive work for the highest demands in crafts and watchmaking. The screwdrivers with rotating hexagonal head and fluted fine screw handle allow the controlled transmission of strong torques.</p> 		250-042	PH0000	84 mm	10	10,92 EUR	
		250-043	PH000	100 mm	10	10,92 EUR	
		250-044	PH00	100 mm	10	10,92 EUR	
		250-045	PH0	112 mm	10	10,92 EUR	
		250-046	PH1	112 mm	10	2,38 EUR	
250-100	TU_RES	Item number				Price	
<p>The watchmaker's screwdrivers with interchangeable blades in the magazine of the 250 series are used for sensitive work for the highest demands in crafts and watchmaking. Thanks to the rotatable hexagonal head and fluted fine screw handle, it is possible to transmit strong torques in a controlled manner.</p> 		250-120	1,5; 2; 2,5; 3	115 mm	10	32,60 EUR	
		250-130	PH0; PH00; PH000; PH0000	115 mm	10	32,60 EUR	
		250-140	1,5; 2,0; 2,5; 3,0; PH00	115 mm	10	32,60 EUR	
250-500	Ku-STA	Item number				Price	
<p>The watchmaker's screwdriver sets of the 250 series are used for sensitive work for the highest demands in crafts and watchmaking. The screwdrivers with rotating hexagonal head and fluted fine screw handle allow the controlled transmission of strong torques.</p> 		250-500	PH000; PH00; PH0		10	41,60 EUR	
		250-520	PH00; PH0	1,0; 1,5; 2,0; 3,0	10	72,60 EUR	
		250-540		1,0; 1,5; 2,0; 2,5; 3,0; 3,5	10	72,60 EUR	
		250-545		1,0; 1,5; 1,8; 2,3; 2,9	10	60,00 EUR	
250-550	Stück	Item number				Price	
<p>The watchmaker's screwdriver sets in the wooden case of the 250 series are used for delicate work for the highest demands in crafts and watchmaking. The screwdrivers with rotating hexagonal head and fluted fine screw handle allow the controlled transmission of strong torques.</p> 		250-550	PH0; PH00; PH000; PH0000	84-112 mm	5	87,00 EUR	
		250-560	1,0; 1,5; 2,0; 2,5; 3,0; 3,5	80-112 mm	5	88,60 EUR	
		250-570	1,0; 1,5; 2,0; 3,0	80-112 mm	5	88,60 EUR	
250-600	Stück	Item number				Price	
<p>The 250 series watchmaker's screwdriver sets in a wooden stand are used for delicate work to meet the highest demands in the trades and watchmaking industry. The screwdrivers with a rotating hexagon head and fluted fine screwdriver handle allow the controlled transfer of high torques.</p> 		250-600	NEW	1,0; 1,5; 2,0; 3,0; PH00; PH0	80-112 mm	5	96,00 EUR

Grip / Hold > Grip / Hold > Tool holder





280	TU_RES	Item number		 DIN 352		Price
<p>The tool and drill holders with ratchet of the 280 series are tool holders for thread cutting and reaming. Their short design makes them particularly suitable for hard-to-reach places.</p> 		280-085	2 - 5,5	M2 - M8	1	22,00 EUR
		280-100	4,5 - 8	M5 - M12	1	27,40 EUR
		280-250	2 - 5,5	M1 - M10	1	34,60 EUR
		280-300	4,5 - 8	M5 - M12	1	43,60 EUR

Soft-face mallet > Hammering > Soft-face hammer SELECTHOR

K-Selecthor	Ku-STA	Item number		 L		Price
<p>The Selecthor GU soft-face hammer with rubber impact inserts can be used to precisely work, position and align impact-sensitive surfaces. The impact inserts are low-wear, damping and last longer than a conventional rubber mallet.</p> 		K-SELECTHOR-01	40 mm	300 mm	1	368,80 EUR
3-GU-GU-1	Ku-STA	Item number		 L		Price
<p>The Selecthor GU soft-face hammer with rubber impact inserts can be used to precisely work, position and align impact-sensitive surfaces. The impact inserts are low-wear, damping and last longer than a conventional rubber mallet.</p> 		3-030111-GU-GU-1	30 mm	300 mm	1	58,38 EUR
		3-040111-GU-GU-1	40 mm	330 mm	1	45,80 EUR
		3-050111-GU-GU-1	50 mm	380 mm	1	62,00 EUR
		3-060111-GU-GU-1	60 mm	410 mm	1	80,60 EUR
		3-080111-GU-GU-1	80 mm	500 mm	1	143,60 EUR
		3-080112-GU-GU-1	80 mm	900 mm	1	166,00 EUR
3-KU-KU-1	Ku-STA	Item number		 L		Price
<p>The Selecthor KU soft-face hammer with plastic impact inserts can be used to precisely work, position and align impact-sensitive surfaces. The impact inserts are universally applicable and are used in particular for assembly, repair and maintenance work.</p> 		3-030111-KU-KU-1	30 mm	300 mm	1	36,40 EUR
		3-040111-KU-KU-1	40 mm	330 mm	1	52,60 EUR
		3-050111-KU-KU-1	50 mm	380 mm	1	76,40 EUR
		3-060111-KU-KU-1	60 mm	410 mm	1	99,60 EUR





3-NY-NY-1	Ku-STA	Item number		 L		Price
<p>With the Selecthor NY soft-face hammer with nylon impact inserts, impact-sensitive surfaces can be precisely machined, positioned and aligned. The impact inserts are used in particular in toolmaking and mechanical engineering, for bending and folding work or loosening tyres/ rims.</p>		3-030111-NY-NY-1	30 mm	300 mm	1	42,60 EUR
		3-040111-NY-NY-1	40 mm	330 mm	1	60,00 EUR
		3-050111-NY-NY-1	50 mm	380 mm	1	88,20 EUR
		3-060111-NY-NY-1	60 mm	410 mm	1	114,00 EUR
		3-080111-NY-NY-1	80 mm	500 mm	1	210,20 EUR
		3-080112-NY-NY-1	80 mm	900 mm	1	240,60 EUR
3-NY-NY-0	Ku-STA	Item number		 L		Price
<p>The Selecthor NY/NY sledgehammer is equipped with nylon inserts on both sides and offers excellent impact properties. The white impact insert nylon with a hardness of Shore 85D is a very hard, durable insert with a very high strength.</p>		3-100111-NY-NY-0	100 mm	1.020 mm	1	385,40 EUR
		3-125111-NY-NY-0	125 mm	1.020 mm	1	514,20 EUR

Spare parts > Spare parts > Selecthor head holder half





30003004	Ku-STA	Item number				Price
<p>The head holder halves are spare parts for the "SELECTHOR" soft-face hammers and can be easily replaced if the tools are damaged.</p> 		30003004	3-030111-KU-KU-1, 3-030111-NY-NY-1, 3-030111-GU-GU-1, K-SELECTHOR-01	0 kg	1	36,40 EUR
		30004004	3-040111-GU-GU-1, 3-040111-GU-KU-1, 3-040111-KU-KU-1, 3-040111-NY-NY-1	0 kg	1	36,40 EUR
		30005004	3-050111-GU-GU-1, 3-050111-KU-KU-1, 3-050111-NY-NY-1	0 kg	1	36,40 EUR
		30006004	3-060111-GU-GU-1, 3-060111-KU-KU-1, 3-060111-NY-NY-1	0 kg	1	36,40 EUR
		30008004	3-080111-GU-GU-1, 3-080112-GU-GU-1, 3-080111-NY-NY-1, 3-080112-NY-NY-1	0 kg	1	36,40 EUR
		30010004	3-125111-NY-NY-0, 3-100111-NY-NY-0	0 kg	1	36,40 EUR



Spare parts > Spare parts > Hammer handle

300203026 Ku-STA	Item number				Price
<p>The ergonomically shaped handle made of high-quality hickory wood guarantees ideal handling and impact precision.</p> 	300203026	3-030111-KU-KU-1, 3-030111-NY-NY-1, 3-030111-GU-GU-1, K-SELECTH OR-01	0,085 kg	1	36,40 EUR
	300204026	3-040111-GU-GU-1, 3-040111-GU-KU-1, 3-040111-KU-KU-1, 3-040111-NY-NY-1	0,135 kg	1	36,40 EUR
	300205026	3-050111-GU-GU-1, 3-050111-KU-KU-1, 3-050111-NY-NY-1	0,17 kg	1	36,40 EUR
	300206026	3-060111-GU-GU-1, 3-060111-KU-KU-1, 3-060111-NY-NY-1	0,215 kg	1	36,40 EUR
	300208026	3-080111-GU-GU-1, 3-080111-NY-NY-1	0,25 kg	1	36,40 EUR
	300208126	3-080112-GU-GU-1, 3-080112-NY-NY-1	0,57 kg	1	36,40 EUR
	300212526	3-125111-NY-NY-0, 3-100111-NY-NY-0	1,055 kg	1	36,40 EUR





Spare parts > Spare parts > Selecthor function insert

3003028 Ku-STA	Item number				Price
<p>The functional inserts are spare parts for the "SELECTHOR" soft-face hammers and can be easily replaced if the tools are damaged.</p> 	3003028	3-030111-KU-KU-1, 3-030111-NY-NY-1, 3-030111-GU-GU-1, K-SELECTHOR-01	0 kg	1	36,40 EUR
	3004028	3-040111-GU-GU-1, 3-040111-GU-KU-1, 3-040111-KU-KU-1, 3-040111-NY-NY-1	0 kg	1	36,40 EUR
	3005028	3-050111-GU-GU-1, 3-050111-KU-KU-1, 3-050111-NY-NY-1	0 kg	1	36,40 EUR
	3006028	3-060111-GU-GU-1, 3-060111-KU-KU-1, 3-060111-NY-NY-1	0,315 kg	1	36,40 EUR
	3008028	3-080111-GU-GU-1, 3-080112-GU-GU-1, 3-080111-NY-NY-1, 3-080112-NY-NY-1	0 kg	1	36,40 EUR

















Optional extensions > Accessories > Soft-face mallet accessories





3010-21	Ku-STA	Item number				Price
<p>The rubber impact insert with a hardness of Shore 50D is a very low-wear, cushioning insert that lasts much longer than a conventional rubber mallet. The rubber impact insert is used, among other things, in gardening/landscaping and for paving work.</p> 		30103021	30 mm	3-030111-GU-GU-1, K-SELECTHOR-01	1	5,00 EUR
		30104021	40 mm	3-040111-GU-GU-1, 3-040111-GU-KU-1	1	7,00 EUR
		30105021	50 mm	3-050111-GU-GU-1	1	9,00 EUR
		30106021	60 mm	3-060111-GU-GU-1	1	12,60 EUR
		30108021	80 mm	3-080111-GU-GU-1, 3-080112-GU-GU-1	1	22,00 EUR
3020-21	Ku-STA	Item number				Price
<p>The white nylon impact insert with a hardness of Shore 85D is a very hard, durable insert with a very high strength. The nylon impact insert is used in foundries, mould making, automotive repair, road construction and heavy industry.</p> 		30203021	30 mm	3-030111-NY-NY-1	1	7,60 EUR
		30204021	40 mm	3-040111-NY-NY-1	1	12,00 EUR
		30205021	50 mm	3-050111-NY-NY-1	1	19,00 EUR
		30206021	60 mm	3-060111-NY-NY-1	1	25,60 EUR
		30208021	80 mm	3-080111-NY-NY-1, 3-080112-NY-NY-1	1	48,40 EUR
		30210021	100 mm	3-100111-NY-NY-0	1	111,80 EUR
		30212521	125 mm	3-125111-NY-NY-0	1	158,40 EUR
3040-21	Ku-STA	Item number				Price
<p>The plastic impact insert with a hardness of Shore 75D has a special strength and is intended for universal use. The plastic impact insert is used in toolmaking and mechanical engineering, among other areas. The impact inserts are available in sizes D30 to D60.</p> 		30403021	30 mm	3-030111-KU-KU-1	1	5,00 EUR
		30404021	40 mm	3-040111-KU-KU-1	1	9,60 EUR
		30405021	50 mm	3-050111-KU-KU-1	1	14,56 EUR
		30406021	60 mm	3-060111-KU-KU-1	1	20,60 EUR





Soft-face mallet > Hammering > Soft-face hammer





343	TU_RES	Item number		L 		Price
Recoilless soft-face hammers		343-050	0.630	30,8 mm	1	82,00 EUR
		343-060	0	34,5 mm	1	133,20 EUR





Pulling > External > Steering wheel puller

31	Ku-STA	Item number	 min. - max.			Price
The universal steering wheel puller is used to gently pull off a wide variety of steering wheels. The particularly strong design of the puller can withstand even the heaviest loads.		31-1	30 mm - 60 mm	5,09 kg	1	508,20 EUR
		31-2	80 mm - 90 mm	4,86 kg	1	508,20 EUR
32	Ku-STA	Item number	 min. - max.	 max.		Price
The steering wheel puller is used to gently pull off steering wheels with three or four spokes. The particularly strong design of the puller can withstand even the heaviest loads.		32-1	53 mm - 92 mm	100 mm	1	401,20 EUR
		32-2	53 mm - 92 mm	120 mm	1	528,60 EUR
33	Ku-STA	Item number	 min. - max.	 max.		Price
The 2-armed steering wheel puller is used to pull off steering wheels with narrow puller slots. The two short puller arms are ideal for sports steering wheels. Thanks to the slim design of the puller, it is possible to reach into narrow puller slots to reach the steering wheel.		33	41 mm - 83 mm	122 mm	1	232,20 EUR
33-P	KU-STA	Item number				Price
The short trigger hook is suitable for steering wheel pullers of the 33 series. The steering wheel puller is suitable for pulling off sports steering wheels thanks to the short trigger hooks.		033001	33	0,09 kg	1	60,00 EUR
		033003	33	0,1 kg	1	60,00 EUR



34	KU-STA	Item number				Price
<p>The 2-armed steering wheel puller is used to pull off steering wheels with large puller slots. Thanks to their design, the arms can be adjusted in any direction. Thanks to the stable design of the puller, it is possible to reach into large puller slots to reach the steering wheel.</p> 		34-0	28 mm - 90 mm	85 mm	1	172,60 EUR
		34-1	28 mm - 90 mm	85 mm	1	238,40 EUR

34-P	KU-STA	Item number				Price
<p>The trigger hooks are spare parts for steering wheel pullers of the 34 series. The short or long trigger hooks are for universal use on steering wheels with large puller slots.</p> 		034000	34-1	0 kg	1	80,00 EUR
		034001	34-1, 34-0	0 kg	1	60,00 EUR



34-E	KU-STA	Item number				Price
<p>The pair of trigger hooks with pressure piece is suitable for steering wheel pullers of the 34 series and, thanks to the pressure piece, also the steering wheel of the Opel Frontera.</p> 		34-E	34-0	0,76 kg	1	120,00 EUR

315	TU_RES	Item number				Price
<p>The tool holders of the 315 series are used to hold various tools for universal use in trade, industry and workshops. The 315 series is drilled through.</p> 		315-801	0 mm - 1 mm	80 mm	5	12,60 EUR
		315-802	1 mm - 2 mm	80 mm	5	12,60 EUR



Cutting / loosening > Cutting / loosening > Disc cutter

321	TU_RES	Item number	\emptyset			Price
<p>The disc cutter is used for cutting discs, leather, paper, pressboard and plastic as well as for making sealing rings. The sharp cutting blade is guided on a rail and can be aligned with millimetre precision.</p> 		321-200	40 mm - 200 mm	0,495 kg	1	91,60 EUR
		321-400	40 mm - 400 mm	0,61 kg	1	106,60 EUR
		321-600	40 mm - 600 mm	0,75 kg	1	124,40 EUR
		321-800	40 mm - 800 mm	0,88 kg	1	143,60 EUR

Spare parts > Spare parts > Spare knife

321-800	KU_STA	Item number				Price
<p>The replacement knives are spare parts for disc cutters 321 and 322. Available are replacement knives, holders for replacement knives or both together. Knives in good condition make the cutting process much easier.</p> 		321-801	321-800	0,04 kg	1	38,00 EUR
		321-802	321-800	0,045 kg	1	21,80 EUR
		322-803	322-800	0,07 kg	1	46,40 EUR
322	TU_RES	Item number	\emptyset			Price
<p>The disc cutter with two knives is used for cutting discs and sealing rings made of rubber, leather, paper, pressboard and plastic. The two sharp cutting blades are guided on a rail that can be aligned with millimetre precision.</p> 		322-200	40 mm - 200 mm	0,56 kg	1	140,20 EUR
		322-400	40 mm - 400 mm	0,68 kg	1	157,60 EUR
		322-600	40 mm - 600 mm	0,825 kg	1	181,80 EUR
		322-800	40 mm - 800 mm	0,95 kg	1	202,60 EUR

Cutting / loosening > Cutting / loosening > Punching and cutting

326-KS	TU_HEN	Item number	\emptyset			Price
<p>The 9-piece set of Henkelli irons with different diameters is used for punching or making seals and gaskets from rubber, leather, felt, plastic, cork and various materials. Thanks to the strong design, various materials can be processed.</p> 		326-109	3; 5; 7; 9; 11; 13; 15; 17; 19	100; 110; 110; 110; 125; 125; 137; 137; 141	1	172,20 EUR
		326-119	2; 3; 4; 5; 6; 7; 8; 9; 10; 11; 12; 13; 14; 15; 16; 17; 18; 19; 20	100 - 141	1	370,80 EUR
		326-120	3; 5; 6; 8; 10; 12; 13; 14; 16; 19; 22; 25	100 - 162	1	279,20 EUR
		326-130	2; 4; 6; 8; 10; 12; 14; 16; 18; 20; 22; 24; 26; 28; 30	100 - 175	1	408,40 EUR
326-TS	TU_HEN	Item number	\emptyset			Price
<p>The 24-piece set of Henkelli irons with different diameters is used for punching or making seals and gaskets from rubber, leather, felt, plastic, cork and various materials. Thanks to the strong design, various materials can be processed.</p> 		326-230	2; 3; 4; 5; 6; 7; 8; 9; 10; 11; 12; 13; 14; 15; 16; 17; 18; 19; 20; 22; 24; 25; 28; 30	100 - 175	1	650,20 EUR













The Henkellocheisen are used for punching or making seals and sealing rings from rubber, leather, felt, plastic, cork and various materials. Thanks to the particularly strong design of the Henkellocheisen, a wide variety of materials can be processed.







Item number	Ø	L		Price
326-100	100	380 mm	1	1.023,20 EUR
326-044	44	205 mm	1	125,20 EUR
326-043	43	205 mm	1	124,20 EUR
326-042	42	205 mm	1	117,60 EUR
326-041	41	205 mm	1	115,60 EUR
326-040	40	190 mm	1	98,00 EUR
326-039	39	190 mm	1	94,60 EUR
326-038	38	190 mm	1	91,60 EUR
326-037	37	180 mm	1	87,40 EUR
326-036	36	180 mm	1	78,60 EUR
326-035	35	180 mm	1	75,20 EUR
326-034	34	180 mm	1	73,60 EUR
326-033	33	175 mm	1	69,60 EUR
326-045	45	205 mm	1	126,20 EUR
326-046	46	205 mm	1	127,80 EUR
326-047	47	215 mm	1	130,60 EUR
326-095	95	365 mm	1	928,20 EUR
326-090	90	365 mm	1	822,80 EUR
326-085	85	340 mm	1	740,00 EUR
326-080	80	340 mm	1	651,80 EUR
326-075	75	255 mm	1	517,80 EUR
326-070	70	250 mm	1	442,20 EUR
326-065	65	240 mm	1	334,80 EUR
326-060	60	240 mm	1	299,80 EUR
326-055	55	220 mm	1	217,20 EUR
326-050	50	215 mm	1	140,20 EUR
326-049	49	215 mm	1	137,00 EUR
326-048	48	215 mm	1	135,00 EUR
326-032	32	175 mm	1	65,20 EUR
326-031	31	175 mm	1	62,00 EUR
326-030	30	175 mm	1	58,20 EUR
326-014	14	137 mm	10	18,40 EUR
326-013	13	125 mm	10	17,40 EUR
326-012	12	125 mm	10	17,00 EUR
326-011	11	125 mm	10	14,98 EUR
326-010	10	110 mm	10	14,00 EUR
326-009	9	110 mm	10	11,80 EUR
326-008	8	110 mm	10	11,80 EUR
326-007	7	110 mm	10	10,92 EUR
326-006	6	110 mm	10	10,92 EUR
326-005	5	110 mm	10	10,92 EUR
326-004	4	100 mm	10	10,92 EUR
326-003	3	100 mm	10	10,92 EUR
326-015	15	137 mm	10	20,60 EUR
326-016	16	137 mm	10	23,00 EUR
326-017	17	137 mm	10	24,80 EUR
326-029	29	175 mm	1	56,80 EUR
326-028	28	175 mm	1	55,40 EUR
326-027	27	162 mm	1	47,80 EUR
326-026	26	162 mm	1	45,40 EUR
326-025	25	162 mm	1	44,20 EUR
326-024	24	153 mm	1	38,00 EUR
326-023	23	153 mm	1	36,60 EUR
326-022	22	153 mm	1	35,80 EUR
326-021	21	153 mm	1	33,20 EUR
326-020	20	141 mm	10	31,00 EUR
326-019	19	141 mm	10	27,00 EUR



326	TU_HEN	Item number	∅	L		Price
		326-018	18	141 mm	10	26,00 EUR
		326-002	2	100 mm	10	10,92 EUR
326-300	TU_RES	Item number	∅	Stück pieces		Price
<p>The ring punching tool set is used for punching or producing seals and sealing rings made of rubber, leather, felt, plastic, cork as well as fabrics. Thanks to the double holder, sealing rings can be made in just one operation.</p> 		326-330	3; 4; 6; 8; 10; 12; 14; 16; 18; 20; 22; 24; 26; 28; 30	16	1	430,60 EUR
		326-350	2; 3; 4; 5; 6; 7; 8; 9; 10; 12; 14; 16; 18; 20; 22; 24; 26; 28; 30; 32; 34; 36; 38; 40; 42; 44; 46; 48; 50	32	1	798,40 EUR
		326-360	2; 3; 4; 6; 8; 10; 12; 14; 16; 18; 20; 22; 24; 26; 28; 30; 32; 34; 36; 38; 40; 42; 44; 46; 48; 50; 52; 54; 56; 58; 60	37	1	1.509,00 EUR
		326-320	3; 4; 6; 8; 10; 12; 14; 16; 18; 20	11	1	221,20 EUR



Spare parts > Spare parts > Punching knife / punching die holder

326-400	TU_HEN	Item number				Price		
<p>The replacement punching knives are spare parts for ring punching tools of the series 326. The cutting edge part is stable and inductively rehardened.</p> 		326-402	326-002	0,01 kg	1	22,00 EUR		
		326-430	326-030	0,04 kg	1	34,00 EUR		
		326-432	326-032	0,07 kg	1	44,00 EUR		
		326-434	326-034	0,08 kg	1	44,00 EUR		
		326-436	326-036	0,33 kg	1	44,00 EUR		
		326-438	326-038	0 kg	1	44,00 EUR		
		326-440	326-040	0,075 kg	1	43,60 EUR		
		326-442	326-042	0,1 kg	1	55,40 EUR		
		326-444	326-044	0,095 kg	1	55,40 EUR		
		326-446	326-046	0,105 kg	1	55,40 EUR		
		326-448	326-048	0,095 kg	1	55,40 EUR		
		326-450	326-050	0 kg	1	55,40 EUR		
		326-452		0,15 kg	1	124,20 EUR		
		326-454		0,18 kg	1	124,00 EUR		
		326-456		0,185 kg	1	124,20 EUR		
		326-458		0,18 kg	1	124,20 EUR		
		326-428	326-028	0,04 kg	1	34,00 EUR		
		326-426	326-026	0,04 kg	1	34,00 EUR		
		326-403	326-003	0,01 kg	1	22,00 EUR		
		326-404	326-004	0,01 kg	1	22,00 EUR		
		326-405	326-005	0,01 kg	1	22,00 EUR		
		326-406	326-006	0,01 kg	1	22,00 EUR		
		326-407	326-007	0,01 kg	1	22,00 EUR		
		326-408	326-008	0,01 kg	1	22,00 EUR		
		326-409	326-009	0,01 kg	1	22,20 EUR		
		326-410	326-010	0,01 kg	1	22,00 EUR		
		326-412	326-012	0,025 kg	1	26,00 EUR		
		326-414	326-014	0,025 kg	1	26,00 EUR		
		326-416	326-016	0,025 kg	1	26,00 EUR		
		326-418	326-018	0,025 kg	1	26,00 EUR		
		326-420	326-020	0,025 kg	1	26,00 EUR		
		326-422	326-022	0,045 kg	1	34,00 EUR		
		326-424	326-024	0,04 kg	1	34,00 EUR		
		326-460	326-060	0 kg	1	124,00 EUR		
		326-500	TU_HEN	Item number				Price
		<p>The punch holders are spare parts for ring punching tools of the series 326. They are used for inserting the punching tools when punching or producing seals and sealing rings made of rubber, leather, felt, plastic, cork, fabric, etc.</p> 		326-553	326-350	0,52 kg	1	239,80 EUR
326-573	326-360, 326-320			0,345 kg	1	68,80 EUR		
326-575	326-330			0,455 kg	1	119,20 EUR		
326-580	326-330, 326-350, 326-360			0,515 kg	1	97,20 EUR		
326-590	TU_HEN	Item number				Price		
<p>The punch block holders are spare parts for ring punching tools of the series 326. They are used for inserting the punch blocks when punching or making seals and gaskets of rubber, leather, felt, plastic, cork, fabric, etc.</p> 		326-590	326-350	0,033 kg	1	136,60 EUR		
		326-592	326-360	0,575 kg	1	199,80 EUR		





326-595	TU_HEN	Item number				Price
The centre point is a spare part for ring punching tool series 326.		326-595	326-350, 326-330, 326-360, 326-320	0,035 kg	1	65,20 EUR





Signing / labelling > Signing / labelling > Stencils





327-B	TU_RES	Item number		Sheet thickness [mm]		Price
The professional marking stencil set letters with plug-in mechanism of the series 327 is used for marking shipping crates, wooden boxes, parking spaces or similar by means of marking ink and marking roller. The set has a standardised typeface according to DIN 1451 and is reusable.		327-020-B	20 mm	0,15 mm	1	35,80 EUR
		327-040-B	40 mm	0,15 mm	1	47,80 EUR
		327-050-B	50 mm	0,15 mm	1	53,80 EUR
		327-070-B	70 mm	0,15 mm	1	76,00 EUR
		327-100-B	100 mm	0,15 mm	1	133,60 EUR
		327-150-B	150 mm	0,3 mm	1	221,80 EUR
		327-200-B	200 mm	0,3 mm	1	507,80 EUR
		327-300-B	300 mm	0,3 mm	1	1.211,40 EUR





327-Z	TU_RES	Item number		Sheet thickness [mm]		Price
The professional marking stencil set numbers with plug-in mechanism of the series 327 is used for marking shipping crates, wooden boxes, parking spaces or similar by means of marking ink and marking roller. The set has a standardised typeface according to DIN 1451 and is reusable.		327-020-Z	20 mm	0,15 mm	1	14,56 EUR
		327-040-Z	40 mm	0,15 mm	1	19,60 EUR
		327-050-Z	50 mm	0,15 mm	1	22,00 EUR
		327-070-Z	70 mm	0,15 mm	1	31,00 EUR
		327-100-Z	100 mm	0,15 mm	1	48,40 EUR
		327-150-Z	150 mm	0,3 mm	1	99,00 EUR
		327-200-Z	200 mm	0,3 mm	1	178,80 EUR
		327-300-Z	300 mm	0,3 mm	1	463,60 EUR

Signing / labelling > Signing / labelling > Strike numbers and letters



328	TU_SGR	Item number				Price
The 9-piece standard impact number set of the 328 series is used for trouble-free marking of workpieces with a strength of up to 900 N/mm ² (27 HRC). The set has a standardised typeface according to DIN 1451 and a hardness at the engraving between 58 and 61 HRC.		328-101	1 mm	6	1	24,92 EUR
		328-115	15 mm	16	1	78,96 EUR
		328-112	12 mm	14	1	47,88 EUR
		328-110	10 mm	12	1	40,32 EUR
		328-108	8 mm	11	1	30,38 EUR
		328-107	7 mm	10	1	27,02 EUR
		328-106	6 mm	9	1	22,40 EUR
		328-105	5 mm	8	1	20,72 EUR
		328-104	4 mm	7	1	18,90 EUR
		328-103	3 mm	6	1	17,36 EUR
		328-1025	2,5 mm	6	1	17,36 EUR
		328-102	2 mm	6	1	16,94 EUR
		328-1015	1,5 mm	6	1	16,94 EUR
		328-120	20 mm	20	1	122,22 EUR

329	TU_SGR	Item number	A			Price
<p>The 27-piece standard striking letter set of the 329 series is used for trouble-free marking of workpieces with a strength of up to 900 N/mm² (27 HRC). The set has a standardised typeface according to DIN 1451 and a hardness at the engraving between 58 and 61 HRC.</p> 		329-201	1 mm	6	1	75,20 EUR
		329-216	16 mm	16	1	294,00 EUR
		329-215	15 mm	16	1	237,60 EUR
		329-212	12 mm	14	1	144,40 EUR
		329-210	10 mm	12	1	120,20 EUR
		329-208	8 mm	11	1	91,00 EUR
		329-207	7 mm	10	1	80,60 EUR
		329-206	6 mm	9	1	67,40 EUR
		329-205	5 mm	8	1	62,00 EUR
		329-204	4 mm	7	1	56,20 EUR
		329-203	3 mm	6	1	51,20 EUR
		329-2025	2,5 mm	6	1	51,20 EUR
		329-202	2 mm	6	1	49,60 EUR
		329-2015	1,5 mm	6	1	49,60 EUR
		329-220	20 mm	20	1	365,00 EUR
330-000	TU_SGR	Item number	A			Price
<p>The bright nickel-plated 9-piece impact number set with extra heavy quality of the 330 series is used for trouble-free marking of workpieces with a strength of up to 1300 N/mm² (42 HRC). The set has a standardised typeface according to DIN 1451 and a hardness between 58 and 61 HRC.</p> 		330-001	1 mm	6	1	33,20 EUR
		330-015	15 mm	16	1	107,00 EUR
		330-012	12 mm	16	1	95,00 EUR
		330-010	10 mm	14	1	54,20 EUR
		330-008	8 mm	12	1	40,80 EUR
		330-007	7 mm	10	1	36,20 EUR
		330-006	6 mm	10	1	30,00 EUR
		330-005	5 mm	9	1	28,00 EUR
		330-004	4 mm	8	1	31,20 EUR
		330-003	3 mm	7	1	29,60 EUR
		330-0025	2,5 mm	7	1	23,00 EUR
		330-002	2 mm	7	1	32,00 EUR
		330-0015	1,5 mm	6	1	22,60 EUR
		330-020	20 mm	20	1	163,80 EUR
		330-R	TU_SGR	Item number	A	
<p>The right-engraved 9-piece impact number set with extra heavy quality of the 330 series is used for trouble-free marking of workpieces with a strength of up to 1300 N/mm² (42 HRC). The set has a standardised typeface according to DIN 1451 and a hardness between 58 and 61 HRC.</p> 		330-001R	1 mm	7	1	84,00 EUR
		330-002R	2 mm	7	1	43,60 EUR
		330-003R	3 mm	8	1	45,80 EUR
		330-004R	4 mm	9	1	47,00 EUR
		330-005R	5 mm	10	1	52,20 EUR
		330-006R	6 mm	12	1	57,60 EUR
		330-008R	8 mm	14	1	79,00 EUR
		330-010R	10 mm	16	1	107,60 EUR
		330-V	TU_SGR	Item number	A	
<p>The impact head hardened and tempered 9-piece impact number set with extra heavy quality is used for trouble-free marking of workpieces with a strength of up to 1300 N/mm² (42 HRC). The set has a standardised typeface according to DIN 1451 and a hardness between 58 and 61 HRC.</p> 		330-001V	1 mm	7	1	73,40 EUR
		330-002V	2 mm	7	1	48,60 EUR
		330-003V	3 mm	8	1	51,60 EUR
		330-004V	4 mm	9	1	53,20 EUR
		330-005V	5 mm	10	1	58,00 EUR
		330-006V	6 mm	12	1	64,60 EUR
		330-008V	8 mm	14	1	89,00 EUR
		330-010V	10 mm	16	1	119,00 EUR
		330-012V	12 mm	18	1	142,20 EUR

330-P	TU_SGR	Item number	A			Price
<p>The dotted 9-piece impact number set with extra heavy quality of the 330 series is used for trouble-free marking of workpieces with a strength of up to 1300 N/mm² (42 HRC). The set has a standardised typeface according to DIN 1451 and a hardness between 58 and 61 HRC.</p> 		330-003P	3 mm	8	1	90,60 EUR
		330-004P	4 mm	9	1	93,00 EUR
		330-005P	5 mm	10	1	100,80 EUR
		330-006P	6 mm	12	1	112,80 EUR
		330-008P	8 mm	14	1	155,00 EUR
		330-010P	10 mm	16	1	209,40 EUR
330-500	TU_SGR	Item number	A			Price
<p>The 9-piece impact number set with extra heavy quality of the 330 series is used for trouble-free marking of workpieces with a strength of up to 1300 N/mm² (42 HRC). The set has a standardised typeface according to DIN 1451 and a hardness at the engraving between 58 and 61 HRC.</p> 		330-501	1 mm	7	1	36,20 EUR
		330-515	15 mm	18	1	106,60 EUR
		330-512	12 mm	18	1	117,60 EUR
		330-510	10 mm	16	1	60,00 EUR
		330-508	8 mm	14	1	44,20 EUR
		330-506	6 mm	12	1	32,40 EUR
		330-505	5 mm	10	1	29,60 EUR
		330-504	4 mm	9	1	26,40 EUR
		330-503	3 mm	8	1	25,40 EUR
		330-5025	2,5 mm	8	1	28,00 EUR
		330-502	2 mm	7	1	28,00 EUR
		330-5015	1,5 mm	7	1	28,00 EUR
		330-520	20 mm	20	1	188,60 EUR
331-000	TU_SGR	Item number	A			Price
<p>The shiny nickel-plated, 27-piece set of striking sticks with extra heavy quality is used for trouble-free marking of workpieces with a strength of up to 1300 N/mm² (42 HRC). The set has a standardised typeface according to DIN 1451 and a hardness between 58 and 61 HRC.</p> 		331-001	1 mm	6	1	101,20 EUR
		331-002	2 mm	7	1	67,40 EUR
		331-003	3 mm	7	1	84,40 EUR
		331-004	4 mm	8	1	77,20 EUR
		331-005	5 mm	9	1	84,40 EUR
		331-006	6 mm	10	1	90,60 EUR
		331-007	7 mm	10	1	107,20 EUR
		331-008	8 mm	12	1	120,20 EUR
		331-010	10 mm	14	1	158,80 EUR
		331-012	12 mm	16	1	299,00 EUR
		331-015	15 mm	16	1	321,80 EUR
		331-020	20 mm	20	1	493,60 EUR
		331-K	TU_SGR	Item number	A	
<p>The 27-piece set of impact letters with extra heavy quality and small letters is used for trouble-free marking of workpieces with a strength of up to 1300 N/mm² (42 HRC). The set has a standardised typeface according to DIN 1451 and a hardness between 58 and 61 HRC.</p> 		331-001K	1 mm	7	1	141,60 EUR
		331-002K	2 mm	7	1	94,00 EUR
		331-003K	3 mm	8	1	99,00 EUR
		331-004K	4 mm	9	1	103,40 EUR
		331-005K	5 mm	10	1	121,00 EUR
		331-006K	6 mm	12	1	125,20 EUR
		331-008K	8 mm	14	1	172,20 EUR
		331-010K	10 mm	16	1	232,60 EUR
		331-012K	12 mm	18	1	276,40 EUR

331-R	TU_SGR	Item number	A			Price
<p>The right-engraved, 27-piece set of striking sticks with extra heavy quality is used for trouble-free marking of workpieces with a strength of up to 1300 N/mm² (42 HRC). The set has a standardised typeface according to DIN 1451 and a hardness between 58 and 61 HRC.</p> 		331-001R	1 mm	7	1	196,20 EUR
		331-002R	2 mm	7	1	131,40 EUR
		331-003R	3 mm	8	1	137,80 EUR
		331-004R	4 mm	9	1	140,20 EUR
		331-005R	5 mm	10	1	156,60 EUR
		331-006R	6 mm	12	1	173,80 EUR
		331-008R	8 mm	14	1	238,40 EUR
		331-010R	10 mm	16	1	321,80 EUR
331-V	TU_SGR	Item number	A			Price
<p>The impact hardened and tempered, 27-piece set of extra heavy quality impact marking rods is used for trouble-free marking of workpieces with a strength of up to 1300 N/mm² (42 HRC). The set has a standardised typeface according to DIN 1451 and a hardness between 58 and 61 HRC.</p> 		331-001V	1 mm	7	1	219,80 EUR
		331-002V	2 mm	7	1	145,20 EUR
		331-003V	3 mm	8	1	154,20 EUR
		331-004V	4 mm	9	1	159,20 EUR
		331-005V	5 mm	10	1	174,20 EUR
		331-006V	6 mm	12	1	192,80 EUR
		331-008V	8 mm	14	1	265,20 EUR
		331-010V	10 mm	16	1	357,80 EUR
		331-012V	12 mm	18	1	426,40 EUR
331-P	TU_SGR	Item number	A			Price
<p>The dotted, 27-piece set of extra-heavy quality 331 series impact marking rods is used for trouble-free marking of workpieces with a strength of up to 1300 N/mm² (42 HRC). The set has a standardised character pattern according to DIN 1451 and a hardness between 58 and 61 HRC.</p> 		331-003P	3 mm	8	1	268,40 EUR
		331-004P	4 mm	9	1	278,40 EUR
		331-005P	5 mm	10	1	304,40 EUR
		331-006P	6 mm	12	1	336,80 EUR
		331-008P	8 mm	14	1	464,20 EUR
		331-010P	10 mm	16	1	626,60 EUR
331-500	TU_SGR	Item number	A			Price
<p>The 27-piece set of extra-heavy quality 331 series impact marking rods is used for trouble-free marking of workpieces with a strength of up to 1300 N/mm² (42 HRC). The set has a standardised typeface according to DIN 1451 and a hardness between 58 and 61 HRC.</p> 		331-501	1 mm	7	1	109,60 EUR
		331-515	15 mm	18	1	318,80 EUR
		331-512	12 mm	18	1	213,00 EUR
		331-510	10 mm	16	1	179,80 EUR
		331-508	8 mm	14	1	132,40 EUR
		331-506	6 mm	12	1	97,00 EUR
		331-505	5 mm	10	1	87,40 EUR
		331-504	4 mm	9	1	79,80 EUR
		331-503	3 mm	8	1	76,60 EUR
		331-5025	2,5 mm	8	1	84,40 EUR
		331-502	2 mm	7	1	84,40 EUR
		331-5015	1,5 mm	7	1	84,40 EUR
		331-520	20 mm	20	1	564,40 EUR

Signing / labelling > Signing / labelling > Hand stamp

300H-S5	TU_SSO	Item number	A			Price
<p>The hand punches with star of the 300 series are used for trouble-free marking of workpieces with a strength of up to 900 N/mm² (27 HRC). The punches have a hardness at the engraving between 58 and 61 HRC and are suitable for delimiting texts on type plates.</p> 		300H02S5	2 mm	7	1	67,60 EUR
		300H03S5	3 mm	8	1	64,60 EUR
		300H04S5	4 mm	9	1	64,60 EUR
		300H05S5	5 mm	10	1	64,60 EUR
		300H06S5	6 mm	12	1	64,60 EUR
		300H07S5	7 mm	14	1	68,20 EUR
		300H08S5	8 mm	14	1	71,60 EUR
		300H10S5	10 mm	16	1	71,60 EUR
300H-S6	TU_SSO	Item number	A			Price
<p>The hand punches with 6-dash star of the 300 series are used for trouble-free marking of workpieces with a strength of up to 900 N/mm² (27 HRC). The punches have a hardness between 58 and 61 HRC and are suitable for delimiting texts on type plates.</p> 		300H02S6	2 mm	7	1	67,60 EUR
		300H03S6	3 mm	8	1	64,60 EUR
		300H04S6	4 mm	9	1	64,60 EUR
		300H05S6	5 mm	10	1	60,80 EUR
		300H06S6	6 mm	12	1	64,60 EUR
		300H07S6	7 mm	14	1	67,60 EUR
		300H08S6	8 mm	14	1	71,60 EUR
		300H10S6	10 mm	16	1	74,20 EUR

300SZ

TU_SSO







The hand punches with special characters of the 300 series are used for trouble-free marking of workpieces with a strength of up to 900 N/mm² (27 HRC). The punches have a hardness at the engraving between 58 and 61 HRC. Special characters can be easily ordered by article number.

Item number	A			Price
300SZ0812	8 mm	16	1	74,80 EUR
300SZ0802	8 mm	14	1	77,60 EUR
300SZ0801	8 mm	14	1	77,60 EUR
300SZ0610	6 mm	12	1	77,60 EUR
300SZ0609	6 mm	12	1	77,60 EUR
300SZ0608	6 mm	12	1	77,60 EUR
300SZ0607	6 mm	12	1	77,60 EUR
300SZ0606	6 mm	12	1	77,60 EUR
300SZ0605	6 mm	12	1	77,60 EUR
300SZ0604	6 mm	12	1	77,60 EUR
300SZ0603	6 mm	12	1	77,60 EUR
300SZ0602	6 mm	12	1	77,60 EUR
300SZ0601	6 mm	12	1	77,60 EUR
300SZ0510	5 mm	10	1	77,60 EUR
300SZ0509	5 mm	10	1	77,60 EUR
300SZ0508	5 mm	10	1	77,60 EUR
300SZ0803	8 mm	14	1	77,60 EUR
300SZ0804	8 mm	14	1	77,60 EUR
300SZ0612	6 mm	12	1	77,60 EUR
300SZ0512	5 mm	10	1	77,60 EUR
300SZ0811	8 mm	14	1	77,60 EUR
300SZ0611	6 mm	12	1	77,60 EUR
300SZ0511	5 mm	10	1	77,60 EUR
300SZ0411	4 mm	9	1	77,60 EUR
300SZ0311	3 mm	8	1	77,60 EUR
300SZ0409	4 mm	9	1	77,60 EUR
300SZ0309	3 mm	8	1	77,60 EUR
300SZ0810	8 mm	14	1	77,60 EUR
300SZ0809	8 mm	14	1	77,60 EUR
300SZ0808	8 mm	14	1	77,60 EUR
300SZ0807	8 mm	14	1	77,60 EUR
300SZ0806	8 mm	14	1	77,60 EUR
300SZ0805	8 mm	14	1	77,60 EUR
300SZ0507	5 mm	10	1	77,60 EUR
300SZ0506	5 mm	10	1	77,60 EUR
300SZ0306	3 mm	8	1	77,60 EUR
300SZ0305	3 mm	8	1	77,60 EUR
300SZ0304	3 mm	8	1	77,60 EUR
300SZ0303	3 mm	8	1	77,60 EUR
300SZ0302	3 mm	8	1	77,60 EUR
300SZ0301	3 mm	8	1	77,60 EUR
300SZ0210	2 mm	7	1	77,60 EUR
300SZ0209	2 mm	7	1	77,60 EUR
300SZ0208	2 mm	7	1	77,60 EUR
300SZ0207	2 mm	7	1	77,60 EUR
300SZ0206	2 mm	7	1	77,60 EUR
300SZ0205	2 mm	7	1	77,60 EUR
300SZ0204	2 mm	7	1	77,60 EUR
300SZ0203	2 mm	7	1	77,60 EUR
300SZ0202	2 mm	7	1	77,60 EUR
300SZ0307	3 mm	8	1	77,60 EUR
300SZ0308	3 mm	8	1	77,60 EUR
300SZ0505	5 mm	10	1	77,60 EUR
300SZ0504	5 mm	10	1	77,60 EUR
300SZ0503	5 mm	10	1	77,60 EUR
300SZ0502	5 mm	10	1	77,60 EUR
300SZ0501	5 mm	10	1	77,60 EUR

300SZ	TU_SSO	Item number	A			Price
		300SZ0410	4 mm	9	1	77,60 EUR
		300SZ0408	4 mm	9	1	77,60 EUR
		300SZ0407	4 mm	9	1	77,60 EUR
		300SZ0406	4 mm	9	1	77,60 EUR
		300SZ0405	4 mm	9	1	77,60 EUR
		300SZ0404	4 mm	9	1	77,60 EUR
		300SZ0403	4 mm	9	1	77,60 EUR
		300SZ0402	4 mm	9	1	77,60 EUR
		300SZ0401	4 mm	9	1	77,60 EUR
		300SZ0310	3 mm	8	1	77,60 EUR
		300SZ0201	2 mm	7	1	77,60 EUR

Signing / labelling > Signing / labelling > Wheel punching

332-100	TU_STY	Item number	A	...stellig ...-digit		Price
<p>The holder for wheel punches of the 332 series is used as a universal tool holder for wheel punches. Thanks to the spacer sleeves supplied, the holder is able to accommodate wheel punches of different sizes. The punches are suitable for marking stainless steel.</p> 		332-100	2-6 mm	1	1	240,80 EUR
332-110	TU_STY	Item number	A			Price
<p>The wheel punch for numerals of the 332 series is used together with a punch holder to easily mark rows of numerals in workpieces with a strength of up to 1300 N/mm². The set has a hardness at the engraving between 58 and 61 HRC and is suitable for stainless steel.</p> 		332-102	2 mm	6 mm	1	203,20 EUR
		332-103	3 mm	6 mm	1	220,80 EUR
		332-104	4 mm	7 mm	1	235,20 EUR
		332-105	5 mm	8 mm	1	246,60 EUR
		332-106	6 mm	9 mm	1	258,80 EUR
		332-108	8 mm	11 mm	1	291,40 EUR
		332-110	10 mm	12 mm	1	336,40 EUR
		332-112	12 mm	15 mm	1	377,60 EUR
332-120	TU_STY	Item number	A			Price
<p>The wheel punch for letters of the 332 series is used together with a punch holder to easily mark rows of numbers in workpieces with a strength of up to 1300 N/mm². The set has a hardness at the engraving between 58 and 61 HRC and is suitable for stainless steel.</p> 		332-122	2 mm	6 mm	1	610,20 EUR
		332-123	3 mm	6 mm	1	661,00 EUR
		332-124	4 mm	7 mm	1	701,40 EUR
		332-125	5 mm	8 mm	1	741,20 EUR
		332-126	6 mm	9 mm	1	776,60 EUR
		332-128	8 mm	11 mm	1	875,40 EUR
		332-130	10 mm	12 mm	1	1.010,40 EUR
		332-132	12 mm	15 mm	1	1.133,20 EUR
332	TU_STY	Item number	A	...stellig ...-digit		Price
<p>The 332 series wheel marking die is used to easily mark rows of numbers in workpieces with a strength of up to 1300 N/mm². The set has a hardness at the engraving between 58 and 61 HRC. The punches are particularly suitable for marking stainless steel.</p> 		332-352	2 mm	6	1	1.458,00 EUR
		332-353	3 mm	6	1	1.458,00 EUR
		332-354	4 mm	6	1	1.458,00 EUR

333	TU_STY	Item number	A			Price
<p>The type holder of the 333 series is used together with types for multi-digit engraving in industry. The types have a hardness at the engraving between 58 and 60 HRC. The nickel-plated surface leaves no extraneous rust and is particularly suitable for marking stainless steel.</p>		333-000	1,5 - 2,0 mm	0,335 kg	1	174,40 EUR
		333-001	2,5 - 3,0 mm	0,33 kg	1	181,80 EUR
		333-002	4,0 - 5,0 mm	0,63 kg	1	190,20 EUR

333-ST	TU_STY	Item number	A	...-stellig ...-digit		Price
<p>The type holder set of the 333 series is used for multi-digit engraving in industry. The set has a hardness at the engraving between 58 and 60 HRC. The nickel-plated surface leaves no extraneous rust and is particularly suitable for marking stainless steel.</p>		333-015	1,5 mm	15	1	859,00 EUR
		333-020	2,0 mm	15	1	859,00 EUR
		333-025	2,5 mm	10	1	859,00 EUR
		333-030	3,0 mm	10	1	859,00 EUR
		333-040	4,0 mm	10	1	915,20 EUR
		333-050	5,0 mm	8	1	971,00 EUR

333-E	TU_STY	Item number	A			Price
<p>The types of the 333 series are used together with a type holder for multi-digit engraving in industry. The types have a hardness between 58 and 60 HRC. The nickel-plated surface leaves no extraneous rust and is particularly suitable for marking stainless steel.</p>		333-015E/...	1,5 mm	0,001 kg	1	23,20 EUR
		333-020E/...	2 mm	0,001 kg	1	23,20 EUR
		333-025E/...	2,5 mm	0,0026 kg	1	23,20 EUR
		333-030E/...	3 mm	0,0026 kg	1	23,20 EUR
		333-040E/...	4 mm	0,0054 kg	1	25,20 EUR
		333-050E/...	5 mm	0,0068 kg	1	23,20 EUR





Signing / labelling > Signing / labelling > Sealing tools

334-030	TU_RES	Item number	A	Ø		Price
<p>The 334 series tool marks are used for marking and identifying tools. Made of brass or aluminium, the tool marks have an embossed beaded edge and a hole for connection to the workpiece to be marked. Can be individually inscribed on request.</p>		334-030	12 mm	27 mm	20	3,00 EUR
		334-031	12 mm	27 mm	50	2,60 EUR

334-820	TU_RES	Item number	L			Price
<p>The inspection punch pliers of the 334-820 series are used for marking inspection stickers and for cancelling receipts, admission tickets, tickets, etc.</p>		334-820	120 mm	0,18 kg	1	206,20 EUR

334-900	TU_RES	Item number	Ø	L		Price
<p>The side cutter sealing pliers of the 334 series are used for cutting the sealing wire and sealing with only one tool. The precisely manufactured pliers combination is capable of combining a wide range of work in a single tool.</p>		334-900	8 mm	155 mm	1	223,80 EUR

334-910	TU_RES	Item number	Ø	L		Price
<p>The lead sealing pliers of the 334 series are used for universal sealing in trade, industry and workshops. The lead sealing pliers, which are available in different sizes, can seal workpieces universally and are an all-rounder in their application.</p>		334-908	8 mm	130 mm	1	218,80 EUR
		334-910	10 mm	130 mm	1	260,60 EUR

334S	TU_RES	Item number	∅			Price
<p>The stamps for seal tongs of the 334 series are replacement stamps for marking seal tongs of the 334 series. On request, we can produce individual seal stamps with your logo or an individual embossing.</p> 		334-918	8 mm	0,0001 kg	1	20,00 EUR
		334S918	8 mm	0,001 kg	1	303,80 EUR
		334-920	10 mm	0,005 kg	1	20,00 EUR
334-928	TU_RES	Item number	∅			Price
<p>The lead seals of the 334 series are used for universal sealing in trade, industry and workshops. Thanks to the lead seals available in different sizes, workpieces can be sealed universally.</p> 		334-928		1,005 kg	1	103,80 EUR
		334-930			1,02 kg	1
334-929	TU_RES	Item number		L 		Price
<p>The galvanised sealing wire, on a spool, of the 334 series is used for universal sealing in trade, industry and workshops. The sealing wire consists of a core and outer cord and the galvanised iron ensures a good price-performance ratio when sealing.</p> 		334-929	0,5 x 0,3	200.000 mm	1	87,80 EUR
		334-931	0,5 x 0,3	400.000 mm	1	156,60 EUR
334-933	TU_RES	Item number		L 		Price
<p>The galvanised sealing wire, in bundles, of the 334 series is used for universal sealing. The sealing wire consists of a core and outer cord and the galvanised iron ensures a good price-performance ratio when sealing. The wires are packed in bundles of uniform length.</p> 		334-933	0,5 x 0,3	120 mm	1	75,20 EUR
		334-934	0,5 x 0,3	180 mm	1	94,60 EUR

406

KU-SCH

The impact ring spanners (DIN 7444) of the 406 series are used for applications in the commercial vehicle, pipe industry, tank cleaning, petrochemical industry, steel and mining industries, etc. They do not slip as easily as open-end spanners and allow a higher power transmission when accessing the screw.



Item number	SW 	L 		Price
406-24	24	160 mm	1	26,80 EUR
406-70	70	320 mm	1	143,00 EUR
406-75	75	325 mm	1	155,60 EUR
406-80	80	345 mm	1	219,80 EUR
406-85	85	360 mm	1	267,20 EUR
406-90	90	400 mm	1	322,40 EUR
406-95	95	400 mm	1	364,00 EUR
406-100	100	400 mm	1	408,40 EUR
406-105	105	435 mm	1	574,80 EUR
406-110	110	435 mm	1	619,60 EUR
406-115	115	435 mm	1	679,20 EUR
406-65	65	290 mm	1	130,60 EUR
406-60	60	270 mm	1	99,60 EUR
406-27	27	180 mm	1	33,00 EUR
406-30	30	190 mm	1	39,00 EUR
406-32	32	195 mm	1	42,40 EUR
406-34	34	195 mm	1	53,20 EUR
406-36	36	205 mm	1	53,20 EUR
406-38	38	205 mm	1	55,00 EUR
406-41	41	225 mm	1	67,60 EUR
406-46	46	240 mm	1	71,80 EUR
406-50	50	250 mm	1	83,20 EUR
406-55	55	270 mm	1	92,00 EUR
406-120	120	480 mm	1	1.484,80 EUR

Pulling > External > Universal puller with swivelling puller legs

41

KU-STA

The 2-arm universal puller with swivelling puller legs is used to pull bearings, gears and discs. The swivelling puller legs enable individual adjustment to the respective clamping width and depth, even in restricted ambient conditions.



Item number				Price
41-0	0 mm - 60 mm	40 mm	1	49,00 EUR
41-1	0 mm - 65 mm	65 mm	1	49,00 EUR
41-2	0 mm - 80 mm	80 mm	1	56,20 EUR
41-3	0 mm - 90 mm	120 mm	1	110,20 EUR
41-4	0 mm - 130 mm	160 mm	1	113,40 EUR
41-5	0 mm - 180 mm	200 mm	1	210,60 EUR

















41-P





KU-STA

The pair of swivelling pullers is suitable for 2-arm universal pullers of series 41. The robust pullers guarantee particularly safe pulling of bearings, gears and pulleys.











Item number				Price
41-0-40-P	41-0	0,085 kg	1	40,00 EUR
41-1-65-P	41-1	0,11 kg	1	40,00 EUR
41-2-80-P	41-2	0,135 kg	1	40,00 EUR
41-3-120-P	41-3	0,35 kg	1	80,00 EUR
41-4-160-P	41-4	0,12 kg	1	80,00 EUR
41-5-200-P	41-5, 41-5-B	1,825 kg	1	160,00 EUR





















41-T	KU-STA	Item number				Price
The traverses are spare parts for 2-arm universal pullers with swivelling puller hooks of series 41.		41-0-T	41-0, 208-0	0,034 kg	1	40,00 EUR
		41-1-T	41-1, 41-2	0,034 kg	1	40,00 EUR
41-B	Ku-STA	Item number				Price
The 2-arm universal puller with swivelling puller legs and grease-hydraulic spindle is used to pull bearings, gears and discs in all standard sizes. It can be used to remove any component that sits on a shaft and is freely accessible from the outside.		41-5-B	0 mm - 180 mm	200 mm	1	589,20 EUR
42	Ku-STA	Item number				Price
The 3-arm universal puller with swivelling puller legs is used to pull bearings, gears and discs in all standard sizes. It can be used to remove parts that are freely accessible from the outside. The swivelling puller legs can be adjusted to the clamping width and depth.		42-0	0 mm - 60 mm	40 mm	1	65,60 EUR
		42-1	0 mm - 65 mm	65 mm	1	65,60 EUR
		42-2	0 mm - 80 mm	80 mm	1	78,60 EUR
		42-3	0 mm - 90 mm	120 mm	1	150,40 EUR
		42-4	0 mm - 130 mm	160 mm	1	239,80 EUR
		42-5	0 mm - 180 mm	200 mm	1	272,40 EUR
42-S	KU-STA	Item number				Price
The set of swivelling pullers is suitable for 3-arm universal pullers of the 42 series. The robust pullers guarantee particularly safe pulling of bearings, gears and pulleys.		42-0-40-S	42-0	0,14 kg	1	60,00 EUR
		42-1-65-S	42-1	0,17 kg	1	40,00 EUR
		42-2-80-S	42-2	0,195 kg	1	60,00 EUR
		42-3-120-S	42-3	0,54 kg	1	120,00 EUR
		42-4-160-S	42-4	1,32 kg	1	120,00 EUR
		42-5-200-S	42-5, 42-5-B	2,845 kg	1	200,00 EUR
42-T	KU-STA	Item number				Price
The traverses are spare parts for 3-arm universal pullers with swivelling puller hooks of series 42.		42-0-T	42-0, 209-0	0,042 kg	1	40,00 EUR
		42-1-T	42-1, 42-2	0,044 kg	1	40,00 EUR

















42-B	Ku-STA	Item number	 min. - max.	 max.		Price
<p>The 3-arm universal puller with swivelling puller legs and grease-hydraulic spindle is used to pull bearings, gears and discs in all standard sizes. It can be used to remove any component that sits on a shaft and is freely accessible from the outside.</p> 	42-5-B	0 mm - 180 mm	200 mm	1	613,60 EUR	

Pulling > External > Handy pullers with power-transmitting and self-centring puller legs

43	Ku-STA	Item number	 min. - max.	 max.		Price
<p>The handy 2-armed small parts puller with power-transmitting and self-centring puller legs is used for the sensitive removal of small bearings, gears and discs for narrow gaps. The space-saving design of the puller is particularly suitable for electric motors.</p> 	43-1	0 mm - 60 mm	50 mm	1	67,60 EUR	
	43-2	0 mm - 70 mm	70 mm	1	69,40 EUR	
	43-3	0 mm - 80 mm	80 mm	1	71,40 EUR	
	43-001	0 mm - 60 mm	50 mm	1	112,80 EUR	

24	Ku-STA	Item number				Price
<p>The Series 24 ball bearing puller and extractor sets are used for extracting bearings, gears, discs and internal bearings, bearing outer rings and bushes during repairs and maintenance. The set includes internal extractors, counter stays, extractor chucks and external extractors.</p> 	24-A	20-1, 43-1, 22-1, 22-2, 21-1, 21-2, 21-3, 21-4, 21-5, 21-6, 23	17,5 kg	1	1.613,80 EUR	
	24-B	20-1, 20-2, 22-1, 22-2, 21-1, 21-2, 21-3, 21-4, 21-5, 21-6, 21-7, 21-8, 23, 43-1	18 kg	1	2.360,00 EUR	
	24-C	20-1, 20-2, 43-1, 22-1, 22-2, 22-4, 21-1, 21-2, 21-3, 21-4, 21-5, 21-6, 21-7, 21-8, 21-89, 23	23,98 kg	1	3.077,40 EUR	

















43-206	KU-STA	Item number				Price
<p>The mechanical pressure spindles are spare parts for handy small parts extractors of the 43 series. The thin spindle tip enables the extraction of particularly small bearings, gears or washers.</p> 	43-001-206	43-001, 43-011	0,08 kg	1	60,00 EUR	
		43-1-206	43-1, 43-2, 43-11, 43-12, 43-13, 27-A	0,085 kg	1	60,00 EUR
		43-3-206	43-3, 43-13	0,685 kg	1	60,00 EUR
43-P	KU-STA	Item number				Price
<p>The pair of pullers is suitable for 2-arm small parts pullers of the 43 series.</p> 	43-001-50-P	43-001, 27-A	0,07 kg	1	60,00 EUR	
	43-1-50-P	43-1	0,075 kg	1	42,00 EUR	
	43-2-70-P	43-2, 43-1	0,095 kg	1	40,00 EUR	
	43-3-80-P	43-3	0,11 kg	1	40,00 EUR	
43-10	KU-STA	Item number				Price
<p>The handy 3-armed small parts puller with power-transmitting and self-centring puller legs is used for the sensitive removal of small bearings, gears and discs for narrow gaps. The space-saving design of the puller is particularly suitable for electric motors.</p> 	43-11	0 mm - 60 mm	50 mm	1	85,60 EUR	
	43-12	0 mm - 70 mm	70 mm	1	87,00 EUR	
	43-13	0 mm - 80 mm	80 mm	1	92,60 EUR	
	43-011	0 mm - 60 mm	50 mm	1	142,80 EUR	
43-S	KU-STA	Item number				Price
<p>The set of pullers is suitable for 3-arm small parts pullers of the 43 series.</p> 	43-011-50-S	43-011	0,1 kg	1	80,00 EUR	
	43-11-50-S	43-11	0,11 kg	1	60,00 EUR	
	43-12-70-S	43-12	0,14 kg	1	60,00 EUR	
	43-13-80-S	43-13	0,16 kg	1	60,00 EUR	
43-T	KU-STA	Item number				Price
<p>The crossheads are spare parts for 2-arm universal pullers with self-centring puller hooks of series 43</p> 	43-1-T	43-1, 43-2, 43-3, 43-001, 27-A	0,04 kg	1	60,00 EUR	
	43-11-T	43-011, 43-11, 43-12, 43-13	0,04 kg	1	60,00 EUR	





44	Ku-STA	Item number	 min. - max.	 max.		Price
<p>The handy 2-arm industrial puller with power-transmitting and self-centring puller legs is used to pull bearings, gears and discs in all standard sizes. It can be used to remove any component that sits on a shaft and is freely accessible from the outside.</p>	 	44-1	0 mm - 100 mm	100 mm	1	79,80 EUR
		44-2	0 mm - 120 mm	120 mm	1	126,80 EUR
		44-3	0 mm - 160 mm	160 mm	1	194,20 EUR
		44-4	0 mm - 250 mm	200 mm	1	268,80 EUR
		44-5	45 mm - 300 mm	250 mm	1	354,00 EUR
		44-6	55 mm - 375 mm	280 mm	1	568,54 EUR
		44-7	40 mm - 450 mm	380 mm	1	1.260,00 EUR
		44-8	100 mm - 650 mm	500 mm	1	1.680,00 EUR
44-P	Ku-STA	Item number				Price
<p>The pair of pullers is suitable for 2-arm universal pullers of the 44 series. The robust pullers guarantee particularly safe pulling of bearings, gears and pulleys.</p>		44-1-100-P	44-1	0,225 kg	1	60,00 EUR
		44-2-120-P	44-2	0,4 kg	1	120,00 EUR
		44-3-160-P	44-3	0,7 kg	1	120,00 EUR
		44-4-200-P	44-4	1,14 kg	1	200,00 EUR
		44-5-250-P	44-5	1,66 kg	1	320,00 EUR
		44-6-275-P	44-8, 44-7, 44-6	4 kg	1	520,00 EUR
		44-206	Ku-STA	Item number		
<p>The crosshead inner bushings with spindle are spare parts for 2-arm universal pullers with self-centring puller hooks of series 44. The collar of the spindle head prevents the key from slipping off.</p>		44-1-206	44-1, 45-1	0,16 kg	1	60,00 EUR
		44-2-206	44-2, 45-2	0,31 kg	1	120,00 EUR
		44-3-206	44-3, 45-3	0,685 kg	1	120,00 EUR
		44-4-206	44-4, 45-4	1,28 kg	1	200,00 EUR
		44-5-206	44-5, 45-5	1,475 kg	1	200,00 EUR
		44-6-206	44-8, 44-7, 44-6, 45-6	0,61 kg	1	320,00 EUR
		45-7-206	45-7	1,87 kg	1	520,00 EUR
44-T	Ku-STA	Item number				Price
<p>The 2-arm traverses are spare parts for 2-arm universal pullers with self-centring puller hooks of series 44.</p>		44-1-T	44-1	0 kg	1	40,00 EUR
		44-2-T	44-2	0,205 kg	1	60,00 EUR
		44-3-T	44-3	0 kg	1	80,00 EUR
		44-4-T	44-8, 44-7, 44-4, 44-5, 44-6	0,81 kg	1	80,00 EUR

45	Ku-STA	Item number				Price
<p>The handy, 3-armed industrial puller with power-transmitting and self-centring puller legs is used to pull bearings, gears and discs in all standard sizes. It can be used to remove any component that sits on a shaft and is freely accessible from the outside.</p>		45-1	0 mm - 100 mm	100 mm	1	121,40 EUR
		45-2	0 mm - 120 mm	120 mm	1	181,80 EUR
		45-3	0 mm - 160 mm	160 mm	1	271,80 EUR
		45-4	0 mm - 250 mm	200 mm	1	383,40 EUR
		45-5	NEW 45 mm - 300 mm	250 mm	1	756,00 EUR
		45-6	NEW 55 mm - 375 mm	280 mm	1	945,00 EUR
		45-7	NEW 40 mm - 450 mm	380 mm	1	1.148,20 EUR
		45-8	NEW 100 mm - 650 mm	500 mm	1	2.520,00 EUR
45-S	KU-STA	Item number				Price
<p>The set of puller hooks is suitable for 3-arm universal pullers of the 45 series. The robust puller hooks guarantee particularly safe pulling off of bearings, gears and pulleys.</p>		45-1-100-S	45-1	0,335 kg	1	120,00 EUR
		45-2-120-S	45-2	0,6 kg	1	160,00 EUR
		45-3-160-S	45-3	1,045 kg	1	160,00 EUR
		45-4-200-S	45-4	2,09 kg	1	320,00 EUR
		45-5-250-S	45-5	2,52 kg	1	520,00 EUR
		45-6-275-S	45-6	3,23 kg	1	760,00 EUR
		45-7-350-S	45-7	4,81 kg	1	1.000,00 EUR
45-T	KU-STA	Item number				Price
<p>The crossheads are spare parts for 3-arm universal pullers with self-centring puller hooks of series 45</p>		45-1-T	45-1	0,12 kg	1	60,00 EUR
		45-2-T	45-2	0,28 kg	1	60,00 EUR
		45-3-T	45-3	0,64 kg	1	80,00 EUR
		45-4-T	45-4, 45-5, 45-6, 45-7	1,06 kg	1	80,00 EUR









Pulling > External > Heavy pullers with swivel puller legs and combination crossbeam

46	Ku-STA	Item number				Price
<p>The heavy-duty, 2-arm universal puller with swivel puller legs and combination crossbeam is used to pull large bearings, gears and discs in all common sizes. It can be used to remove any component that sits on a shaft and is freely accessible from the outside.</p>		46-1-A	0 mm - 300 mm	300 mm	1	561,20 EUR
		46-2-A	0 mm - 500 mm	450 mm	1	710,20 EUR





46-B	Ku-STA	Item number	 min. - max.	 max.		Price
<p>The heavy-duty, 2-arm universal puller with swivelling puller legs, combination crossbeam and grease-hydraulic spindle is used for removing large, particularly tight-fitting bearings, gears and discs in all common sizes. It can be used to loosen parts that are freely accessible from the outside.</p> 	Ku-STA	46-1-B	0 mm - 300 mm	300 mm	1	1.450,60 EUR
		46-2-B	0 mm - 500 mm	450 mm	1	1.560,40 EUR
47	Ku-STA	Item number	 min. - max.	 max.		Price
<p>The heavy-duty 3-arm universal puller with swivel puller legs and combination crossbeam is used to pull large bearings, gears and discs in all common sizes. It can be used to remove any component that sits on a shaft and is freely accessible from the outside.</p> 	Ku-STA	47-1-A	0 mm - 300 mm	300 mm	1	635,20 EUR
		47-2-A	0 mm - 500 mm	450 mm	1	845,40 EUR
47-B	Ku-STA	Item number	 min. - max.	 max.		Price
<p>The heavy-duty, 3-arm universal puller with swivel puller legs, combination crossbeam and grease-hydraulic spindle is used for removing large, particularly tight-fitting bearings, gears and discs. It can be used to remove components that are freely accessible from the outside.</p> 	Ku-STA	47-1-B	0 mm - 300 mm	300 mm	1	1.556,60 EUR
		47-2-B	0 mm - 500 mm	450 mm	1	1.724,40 EUR
46-47	KU-STA	Item number				Price
<p>The puller legs are spare parts for series 46 and 47. The swivelling puller legs ensure maximum freedom of movement for individual adjustment to the respective span width and depth, even in restricted ambient conditions.</p> 	Ku-STA	46-300	47-1-A, 47-1-B, 46-1-A, 46-1-B	2,08 kg	1	200,00 EUR
		46-450	47-2-A, 47-2-B, 46-2-A, 46-2-B	2,695 kg	1	200,00 EUR

46-47-T	KU-STA	Item number				Price
<p>The crosshead is a spare part for 2- and 3-arm universal pullers with swivelling puller hooks of series 46 and 47.</p> 		46-47-T	47-1-A, 47-2-A, 47-1-B, 47-2-B, 46-1-A, 46-2-A, 46-1-B, 46-2-B	2,94 kg	1	320,00 EUR

Grip / Hold > C-clamps > C-shaped clamps

365	KU-STA	Item number				Price
<p>The all-steel C-screw clamps of the 365 series are used for springy elastic clamping of several workpieces. The screw clamp has a particularly high pressing force due to its trapezoidal spindle. The 365 series has a toggle handle that enables particularly firm tightening.</p> 		365-050	50 mm	50 mm	1	67,40 EUR
		365-075	75 mm	50 mm	1	97,60 EUR
		365-100	100 mm	60 mm	1	119,20 EUR
		365-150	150 mm	75 mm	1	141,00 EUR
		365-200	200 mm	90 mm	1	162,80 EUR
		365-250	250 mm	100 mm	1	274,80 EUR
420	KU-STA	Item number				Price
<p>The C screw clamps with metric fine thread are used to press together and hold several workpieces. The screw clamp ensures precise and measured application of force due to the spindle with metric thread. The 420 series has a toggle handle for particularly firm tightening.</p> 		420-028	28 mm	25 mm	1	40,80 EUR
		420-053	53 mm	38 mm	1	50,80 EUR
		420-078	78 mm	50 mm	1	61,00 EUR
		420-130	130 mm	70 mm	1	103,40 EUR
		420-155	155 mm	76 mm	1	114,60 EUR
		420-206	206 mm	86 mm	1	147,00 EUR

Grip / Hold > Forcing in general > Parallel screw clamps

430	KU-STA	Item number				Price
<p>Thanks to their double spindle guide, the parallel screw clamps of the 430 series are used for precise, parallel adjustment of clamping surfaces in crafts, industry and workshops.</p> 		430-028	28 mm	16 mm	1	20,60 EUR
		430-040	40 mm	25 mm	1	25,40 EUR
		430-055	55 mm	35 mm	1	31,60 EUR
		430-070	70 mm	50 mm	1	43,20 EUR
		430-105	105 mm	70 mm	1	60,00 EUR

431	KU-STA	Item number				Price
<p>The quick-action collets KANT-TWIST of the series 431 are used for internal and external clamping of different profiles. The series 431 convinces with its multifunctionality. It combines the features of clamps, pincers and clamps in a single tool.</p> 	431-001	25 mm	15 - 17	1	91,60 EUR	
	431-002	50 mm	35 - 40	1	103,40 EUR	
	431-003	75 mm	35- 50	1	137,00 EUR	
	431-004	110 mm	60 - 75	1	162,20 EUR	
	431-006	150 mm	60 - 85	1	269,20 EUR	
	431-009	240 mm	80 - 135	1	691,80 EUR	
	431-010	255 mm	150 - 190	1	1.000,60 EUR	
	431-012	300 mm	120 - 170	1	1.116,80 EUR	

432	KU-STA	Item number				Price
<p>The parallel clamps of the 432 series are used for universal internal and external clamping of a wide variety of workpiece shapes. The 432 series has four different surfaces for use on different workpiece shapes, which ensures universal use.</p> 	432-001	25 mm	15 - 20	5	31,00 EUR	
	432-002	50 mm	33 - 42	5	34,00 EUR	
	432-003	75 mm	35 - 49	5	49,60 EUR	
	432-004	110 mm	58 - 78	5	64,60 EUR	
	432-006	150 mm	110 - 128	5	122,20 EUR	

Grip / Hold > Screw clamps > POL screw clamps

440	TU_ZTG	Item number				Price
<p>The 440 series pole screw clamps are used for earthing during welding work. The solid and application-oriented design enables safe clamping. The 440 series has a guide ring for earth cables.</p> 	440-150	150 mm / 60 mm	30 x 8	10	40,40 EUR	
	440-156	150 mm / 60 mm	30 x 8	10	42,00 EUR	
	440-158	150 mm / 80 mm	30 x 8	10	45,40 EUR	

441	TU_ZTG	Item number				Price
<p>The pole screw clamps of the 441 series are used for earthing during welding work. The solid and application-oriented design enables safe clamping. The 441 series has a fixing hole for earth cables.</p> 	441-580	150 mm / 80 mm	22 x 6	10	63,40 EUR	
	441-600	200 mm / 100 mm	30 x 8	10	67,20 EUR	

442	TU_ZTG	Item number				Price
		442-400	400 A	0,265 kg	5	34,58 EUR
		442-600	500 A	0,415 kg	5	38,22 EUR

Grip / Hold > Forcing in general > Mitre welding clamps

450	TU_ZTG	Item number				Price
<p>The 450 series mitre welding guns are used for clamping workpieces at precise angles during welding or for assembly work in trade, industry and workshops. The malleable cast iron body has fixed, cleanly machined contact surfaces at a clamping angle of 90°</p>		450-050	50 mm	1,24 kg	1	183,80 EUR
		450-100	100 mm	2,78 kg	1	282,80 EUR
450-260	KU-STA	Item number				Price
<p>The metal angle clamp of the 450 series is used for clamping workpieces at precise angles during welding or for assembly work in trade, industry and workshops. The malleable cast iron body has fixed, cleanly machined contact surfaces at a clamping angle of 90°.</p>		450-260	90 mm	4,16 kg	1	296,60 EUR

Grip / Hold > Screw clamps > All-steel screw clamps

469

TU_ZGZ

Item number



Price

The all-steel VIRIDIS screw clamps with wooden handle of the 469 series are used for pressing together and holding several workpieces. The built-in spring absorbs vibrations of the workpiece. With its round wooden handle, this series is a classic among screw clamps.



469-0100-050	100 mm / 50 mm	11,5 x 5,7	10	48,60 EUR
469-0250-120	250 mm / 120 mm	22 x 10,5	10	63,80 EUR
469-0300-120	300 mm / 120 mm	22 x 10,5	10	69,00 EUR
469-0400-120-S	400 mm / 120 mm	22 x 10,5	10	91,60 EUR
469-0600-120-S	600 mm / 120 mm	22 x 10,5	5	98,80 EUR
469-0300-140	300 mm / 140 mm	25 x 12	10	80,60 EUR
469-0400-120	400 mm / 120 mm	25 x 12	5	93,20 EUR
469-0500-120	500 mm / 120 mm	25 x 12	5	99,60 EUR
469-0600-120	600 mm / 120 mm	25 x 12	5	105,60 EUR
469-0800-120	800 mm / 120 mm	27 x 13	5	127,00 EUR
469-1000-120	1.000 mm / 120 mm	27 x 13	5	145,00 EUR
469-1250-120	1.250 mm / 120 mm	27 x 13	1	194,60 EUR
469-0400-100	400 mm / 100 mm	19,5 x 9,5	10	61,60 EUR
469-0300-100	300 mm / 100 mm	19,5 x 9,5	10	56,20 EUR
469-0200-050	200 mm / 50 mm	11,5 x 5,7	10	48,40 EUR
469-0300-050	300 mm / 50 mm	11,5 x 5,7	10	60,20 EUR
469-0120-060	120 mm / 60 mm	13,5 x 6,5	10	55,00 EUR
469-0200-060	200 mm / 60 mm	13,5 x 6,5	10	54,20 EUR
469-0300-060	300 mm / 60 mm	13,5 x 6,5	10	39,00 EUR
469-0160-080	160 mm / 80 mm	16 x 7,5	10	62,60 EUR
469-0200-080	200 mm / 80 mm	16 x 7,5	10	40,80 EUR
469-0300-080	300 mm / 80 mm	16 x 7,5	10	65,60 EUR
469-0200-100	200 mm / 100 mm	19,5 x 9,5	10	64,20 EUR
469-0250-100	250 mm / 100 mm	19,5 x 9,5	10	73,60 EUR
469-1500-120	1.500 mm / 120 mm	27 x 13	1	222,80 EUR









469P

TU_ZGZ



The all-steel VIRIDIS screw clamps with 2K comfort grip of the 469P series are used to press together and hold several workpieces. With the built-in spring, the screw clamps absorb the vibrations of the workpiece. The series is equipped with a 2-component handle.











Item number				Price
469P0100-050 NEW	100 mm / 50 mm	11,5 x 5,7	10	31,60 EUR
469P0200-050 NEW	200 mm / 50 mm	11,5 x 5,7	1	34,00 EUR
469P0250-120 NEW	250 mm / 120 mm	22 x 10,5	10	67,40 EUR
469P0300-120 NEW	300 mm / 120 mm	22 x 10,5	1	73,20 EUR
469P0400-120-S NEW	400 mm / 120 mm	22 x 10,5	1	105,00 EUR
469P0600-120-S NEW	600 mm / 120 mm	22 x 10,5	1	105,00 EUR
469P0300-140 NEW	300 mm / 140 mm	25 x 12	10	85,20 EUR
469P0400-120 NEW	400 mm / 120 mm	25 x 12	5	97,40 EUR
469P0500-120 NEW	500 mm / 120 mm	25 x 12	5	103,80 EUR
469P0600-120 NEW	600 mm / 120 mm	25 x 12	5	110,20 EUR
469P0800-120 NEW	800 mm / 120 mm	27 x 13	5	131,80 EUR
469P1000-120 NEW	1.000 mm / 120 mm	27 x 13	5	147,60 EUR
469P1250-120 NEW	1.250 mm / 120 mm	27 x 13	1	198,80 EUR
469P0400-100 NEW	400 mm / 100 mm	19,5 x 9,5	1	66,26 EUR
469P0300-100 NEW	300 mm / 100 mm	19,5 x 9,5	1	61,00 EUR
469P0300-050 NEW	300 mm / 50 mm	11,5 x 5,7	1	39,00 EUR
469P0120-060 NEW	120 mm / 60 mm	13,5 x 6,5	10	34,60 EUR
469P0200-060 NEW	200 mm / 60 mm	13,5 x 6,5	1	39,40 EUR
469P0300-060 NEW	300 mm / 60 mm	13,5 x 6,5	1	42,00 EUR
469P0160-080 NEW	160 mm / 80 mm	16 x 7,5	10	41,60 EUR
469P0200-080 NEW	200 mm / 80 mm	16 x 7,5	1	44,20 EUR
469P0300-080 NEW	300 mm / 80 mm	16 x 7,5	1	51,20 EUR
469P0400-080 NEW	400 mm / 80 mm	16 x 7,5	1	56,28 EUR
469P0200-100 NEW	200 mm / 100 mm	19,5 x 9,5	10	55,80 EUR
469P0250-100 NEW	250 mm / 100 mm	19,5 x 9,5	1	56,20 EUR
469P1500-120 NEW	1.500 mm / 120 mm	27 x 13	1	226,80 EUR

469PU	TU_ZGZ	Item number				Price
<p>The all-steel VIRIDIS screw clamps with 2K comfort folding handle are used to press together and hold several workpieces. With the built-in spring, the screw clamps absorb the vibrations of the workpiece. They are equipped with a 2-component folding handle.</p> 		469PU0200-100 NEW	200 mm / 100 mm	19,5 x 9,5	10	85,60 EUR
		469PU0250-120 NEW	250 mm / 120 mm	22 x 10,5	10	97,40 EUR
		469PU0300-140 NEW	300 mm / 140 mm	25 x 12	10	114,60 EUR
		469PU0400-120 NEW	400 mm / 120 mm	25 x 12	5	126,60 EUR
		469PU0600-120 NEW	600 mm / 120 mm	25 x 12	5	140,20 EUR
469K	TU_ZGZ	Item number				Price
<p>The all-steel VIRIDIS screw clamps with toggle handle of the 469K series are used to press together and hold several workpieces. With the built-in spring, the screw clamps absorb the vibrations of the workpiece. The series has a toggle handle for particularly firm tightening</p> 		469K0160-080	160 mm / 80 mm	16 x 7,5	10	38,00 EUR
		469K1250-120	1.250 mm / 120 mm	27 x 13	5	194,80 EUR
		469K1000-120	1.000 mm / 120 mm	27 x 13	5	144,20 EUR
		469K0800-120	800 mm / 120 mm	27 x 13	5	127,80 EUR
		469K0600-120	600 mm / 120 mm	25 x 12	5	105,60 EUR
		469K0500-120	500 mm / 120 mm	25 x 12	5	99,60 EUR
		469K0400-120	400 mm / 120 mm	25 x 12	10	93,20 EUR
		469K0300-140	300 mm / 140 mm	25 x 12	10	80,60 EUR
		469K0250-120	250 mm / 120 mm	22 x 10,5	10	63,80 EUR
		469K0200-100	200 mm / 100 mm	19,5 x 9,5	10	51,60 EUR
		469K1500-120	1.500 mm / 120 mm	27 x 13	1	222,80 EUR





Grip / Hold > Screw clamps > All-steel lever clamps





472	TU_ZGZ	Item number				Price
<p>The all-steel VIRIDIS 472 series lever clamps are used for fast, effortless clamping of several workpieces with high clamping pressure. The optimised rail profile of the ensures uniform clamping force build-up and greater force reserves, especially when the clamping width is fully utilised.</p> 		472H0120-060	120 mm / 60 mm	13,5 x 6,5	10	69,00 EUR
		472H0160-080	160 mm / 80 mm	16 x 7,5	10	75,20 EUR
		472H0200-100	200 mm / 100 mm	19,5 x 9,5	10	87,40 EUR
		472H0250-120	250 mm / 120 mm	22 x 10,5	10	100,20 EUR
		472H0300-140	300 mm / 140 mm	25 x 12	10	119,00 EUR
		472H0400-120	400 mm / 120 mm	25 x 12	5	125,20 EUR
		472H0500-120	500 mm / 120 mm	25 x 12	5	134,00 EUR
		472H0600-120	600 mm / 120 mm	25 x 12	5	139,40 EUR
		472H0800-120	800 mm / 120 mm	27 x 13	5	168,40 EUR
		472H1000-120	1.000 mm / 120 mm	27 x 13	5	187,20 EUR
473K	TU_ZGZ	Item number				Price
<p>The all-steel locksmith's clamps with toggle handle of the 473K series are used for clamping in heavy-duty applications in crafts, industry and workshops. The heavy-duty locksmith's clamp can also withstand the increased power required and thus enables use in cases of hardship.</p> 		473K0200-120	200 mm / 120 mm	27 x 13	5	103,32 EUR
		473K0250-120	250 mm / 120 mm	27 x 13	5	105,56 EUR
		473K0300-120	300 mm / 120 mm	27 x 13	5	111,58 EUR
		473K0400-120	400 mm / 120 mm	27 x 13	5	118,58 EUR
		473K0500-120	500 mm / 120 mm	27 x 13	5	126,56 EUR
		473K0600-120	600 mm / 120 mm	27 x 13	5	131,32 EUR
475K	TU_ZGZ	Item number				Price
<p>The heavy all-steel locksmith clamps with toggle handle of the 475K series are used for heavy and heavy-duty clamping of workpieces. The heavy-duty locksmith's clamp can withstand the increased power required, enabling it to be used in tough applications.</p> 		475K0250-120	250 mm / 120 mm	30 x 15	5	148,60 EUR
		475K0300-140	300 mm / 140 mm	30 x 15	5	157,20 EUR
		475K0500-140	500 mm / 140 mm	30 x 15	5	192,80 EUR
		475K0800-140	800 mm / 140 mm	30 x 15	5	222,80 EUR
		475K1000-120	1.000 mm / 120 mm	30 x 15	5	245,60 EUR
		475K1250-120	1.250 mm / 120 mm	30 x 15	1	292,40 EUR
		475K1500-120	1.500 mm / 120 mm	30 x 15	1	329,80 EUR

476K	TU_ZGZ	Item number				Price
<p>The heavy-duty U-clamps with toggle handle of the 476K series are used for clamping on T and double-T steel beam profiles in industry. The heavy-duty U-clamp can withstand the increased power required, thus enabling it to be used in tough applications.</p> 		476K0300-140	300 mm / 140 mm	30 x 15	1	183,80 EUR

























480K	TU_ZGZ	Item number				Price
<p>The all-steel construction clamps with toggle handle of the 480K series are used for extra heavy and heavy-duty clamping of workpieces. The steel construction clamps can also withstand the required increased power and thus enable use in cases of hardship.</p> 		480K0300-175	300 mm / 175 mm	40 x 20	1	288,60 EUR
		480K0400-175	400 mm / 175 mm	40 x 20	1	303,80 EUR
		480K0500-175	500 mm / 175 mm	40 x 20	1	316,80 EUR
		480K0600-175	600 mm / 175 mm	40 x 20	1	328,20 EUR
		480K0800-175	800 mm / 175 mm	40 x 20	1	349,40 EUR
		480K1000-175	1.000 mm / 175 mm	40 x 20	1	378,20 EUR
		480K1250-175	1.250 mm / 175 mm	40 x 20	1	462,40 EUR
		480K1500-175	1.500 mm / 175 mm	40 x 20	1	511,00 EUR













Pulling > External > Handy pullers with power-transmitting, self-centring and clamping puller legs

48	Ku-STA	Item number	 min. - max.	 max.		Price
<p>The handy, 2-armed puller with self-centring puller legs is used to remove battery terminals. It can be used to loosen parts that sit on shafts and are freely accessible from the outside. The narrow puller legs are suitable for narrow, hard-to-reach areas.</p> 		48	0 mm - 60 mm	40 mm	1	82,60 EUR









K-482	Ku-STA	Item number				Price
<p>The handy, 2-arm pullers with power-transmitting, self-centring and clamping puller legs in the set are used to pull off bearings, gears and washers for narrow and poorly accessible gaps. They can be used to loosen parts that are freely accessible from the outside.</p> 		K-482	482-1, 482-2, 482-3	2,44 kg	1	406,40 EUR

















482	Ku-STA	Item number	min. - max.	max.		Price
<p>The handy, 2-arm puller with power-transmitting, self-centring and clamping puller legs is used to pull bearings, gears and discs for narrow gaps. It can be used to remove components that sit on shafts and are freely accessible from the outside.</p>		482-1	0 mm - 60 mm	40 mm	1	71,60 EUR
		482-2	4 mm - 85 mm	90 mm	1	99,60 EUR
		482-3	4 mm - 150 mm	150 mm	1	188,60 EUR
		482-4	0 mm - 200 mm	200 mm	1	222,20 EUR
		482-5	0 mm - 250 mm	250 mm	1	263,00 EUR
K-482	Ku-STA	Item number				Price
<p>The handy, 2-arm pullers with power-transmitting, self-centring and clamping puller legs in the set are used to pull off bearings, gears and washers for narrow and poorly accessible gaps. They can be used to loosen parts that are freely accessible from the outside.</p>		K-482	482-1, 482-2, 482-3	2,44 kg	1	406,40 EUR
482-P	KU-STA	Item number				Price
<p>The pair of pullers is suitable for 2-arm universal pullers with Auto-Snap of the 482 series. The spring action and the narrow design allow pulling in hard-to-reach places.</p>		482-1-40-P	482-1	0,08 kg	1	24,00 EUR
		482-2-90-P	482-2	0,115 kg	1	60,00 EUR
		482-3-150-P	482-3	0,31 kg	1	120,00 EUR
		482-4-200-P	482-4	0,287 kg	1	160,00 EUR
		482-5-250-P	482-5	0,36 kg	1	160,00 EUR
482-T	KU-STA	Item number				Price
<p>The crossbars are spare parts for 2-arm universal pullers with Auto-Snap of the 482 series. The pullers are automatically tensioned and centred.</p>		482-1-T	482-1, 482-2, 48	0 kg	1	40,00 EUR
		482-3-T	482-3, 483-3	0 kg	1	60,00 EUR
		482-4-T	482-4, 482-5	0 kg	1	80,00 EUR
482-206	KU-STA	Item number				Price
<p>The Mechanical Pressure Spindles with Bushing and Spring are spare parts for 2- and 3-arm Universal Pullers with Auto-Snap of the 482 and 483 series. The two-sided spindle tip allows an optimal adaptation of the spindle to the shaft.</p>		482-1-206	482-1	0,04 kg	1	54,04 EUR
		482-2-206	482-1, 482-2, 483-2	0,075 kg	1	60,00 EUR
		482-3-206	482-3, 483-3	0,2 kg	1	80,00 EUR
		482-4-206	482-4	0 kg	1	120,00 EUR
		482-5-206	482-5	0,48 kg	1	120,00 EUR
		483-4-206	483-4	0 kg	1	120,00 EUR
		483-5-206	483-5	0,515 kg	1	120,00 EUR

483	Ku-STA	Item number	 min. - max.	 max.		Price
<p>The handy, 3-arm puller with power-transmitting, self-centring and clamping puller legs is used to pull bearings, gears and discs for narrow spaces. It can be used to remove any component that sits on a shaft and is freely accessible from the outside.</p> 		483-2	4 mm - 85 mm	90 mm	1	139,40 EUR
	483-3	4 mm - 150 mm	150 mm	1	223,20 EUR	
	483-4	0 mm - 200 mm	200 mm	1	260,60 EUR	
	483-5	0 mm - 250 mm	250 mm	1	362,00 EUR	
<p>483-S</p> <p>The set of pullers is suitable for 3-arm universal pullers with Auto-Snap of the 483 series. The spring action and the narrow design enable pulling in hard-to-reach places.</p> 	Ku-STA	Item number				Price
	483-2-90-S	483-2	0,059 kg	1	80,00 EUR	
	483-3-150-S	483-3	0,47 kg	1	160,00 EUR	
	483-4-200-S	483-4	0,287 kg	1	200,00 EUR	
483-5-250-S	483-5	1,115 kg	1	320,00 EUR		
<p>483-T</p> <p>The crossbars are spare parts for 3-arm universal pullers with Auto-Snap of the 482 series. The pullers are automatically tensioned and centred.</p> 	Ku-STA	Item number				Price
	483-2-T	483-2	0,108 kg	1	80,00 EUR	
483-4-T	483-4, 483-5	0,517 kg	1	120,00 EUR		
<p>K-486</p> <p>The 3-arm combi puller set with locking mechanism is used for pulling off bearings, gears, washers and the like. The use of the 2- and 3-arm traverse and the included two pairs of puller hook sets make the combi puller universally suitable for external pulling and internal pulling.</p> 	Ku-STA	Item number				Price
K-486-1-22	22-0-17	2,42 kg	1	708,20 EUR		
<p>486</p> <p>The 3-arm combi puller with locking mechanism and combi crosshead is used to pull bearings, gears, discs and the like. By using the 2- and 3-jaw crossbeam and the two pairs of puller hook sets, the combi puller is universally suitable for external removal and internal extraction.</p> 	Ku-STA	Item number	 min. - max.	 min. - max.		Price
486-1	0 mm - 160 mm	55 mm - 180 mm	1	379,80 EUR		
<p>K-486</p> <p>The 3-arm combi puller set with locking mechanism is used for pulling off bearings, gears, washers and the like. The use of the 2- and 3-arm traverse and the included two pairs of puller hook sets make the combi puller universally suitable for external pulling and internal pulling.</p> 	Ku-STA	Item number				Price
K-486-1-22	22-0-17	2,42 kg	1	708,20 EUR		

486-E	KU-STA	Item number				Price
<p>The replacement hooks are spare parts for the 3-arm combi puller with locking mechanism of the 486 series. By changing the puller hooks, this can be used for both external and internal pulling.</p> 		486-1-A	486-1	0 kg	1	120,00 EUR
		486-1-I	486-1	0 kg	1	117,60 EUR
486114		Item number				Price
<p>The replacement body is a spare part for the 3-arm combi puller with locking mechanism of series 486. A damaged basic body can be replaced in this way.</p> 		486114	486-1	0 kg	1	193,90 EUR
486051	KU-STA	Item number				Price
<p>The replacement pin set replaces the pins in the 3-arm combination puller set with locking mechanism of series 486.</p> 		486051	486-1	0 kg	1	120,00 EUR



Cutting / loosening > Cutting / loosening > Screw extractor

49-0-S	Ku-STA	Item number				Price
<p>The screw extractor sets with wide grooved shape are used for extracting broken bolts and screws with right-hand threads. The screw extractors are an indispensable tool that neither hobby screwdrivers nor craftsmen professionals can do without.</p> 		49-0-S	3 - 24	0,195 kg	1	126,20 EUR
49-0	Ku-STA	Item number				Price
<p>The screw extractor with a wide grooved shape is used for extracting broken bolts and screws with right-hand threads. This makes the screw extractor an indispensable tool that neither hobby screwdrivers nor craftsmen can do without.</p> 		49-01	3 mm - 6 mm	0,05 kg	1	14,98 EUR
	49-02	6 mm - 8 mm	0,005 kg	1	18,60 EUR	
	49-03	8 mm - 11 mm	0,01 kg	1	18,60 EUR	
	49-04	11 mm - 14 mm	0,02 kg	1	22,20 EUR	
	49-05	14 mm - 18 mm	0,04 kg	1	23,20 EUR	
	49-06	18 mm - 24 mm	0,12 kg	1	28,00 EUR	

49-S	Ku-STA	Item number				Price
<p>The screw extractor sets with finely grooved shape are used for extracting broken bolts and screws with right-hand threads. The screw extractors are an indispensable tool that neither hobby screwdrivers nor craftsmen professionals can do without.</p> 		49-A	M3 - M18	0,115 kg	1	40,32 EUR
		49-B	M3 - M24	0,22 kg	1	48,30 EUR
		49-C	M3 - M45	0,705 kg	1	97,30 EUR
49	Ku-STA	Item number				Price
<p>The screw extractor with its finely grooved shape is used for extracting broken bolts and screws with right-hand threads. This makes the screw extractor an indispensable tool that neither hobby screwdrivers nor craftsmen can do without.</p> 		49-1	3 mm - 6 mm	0,0005 kg	5	6,80 EUR
		49-2	6 mm - 8 mm	0,01 kg	5	6,80 EUR
		49-3	8 mm - 11 mm	0,015 kg	5	6,60 EUR
		49-4	11 mm - 14 mm	0,03 kg	5	7,60 EUR
		49-5	14 mm - 18 mm	0,05 kg	5	8,68 EUR
		49-6	18 mm - 24 mm	0,1 kg	5	17,00 EUR
		49-7	24 mm - 33 mm	0,165 kg	5	19,00 EUR
		49-8	33 mm - 45 mm	0,29 kg	5	27,00 EUR
		49-9	45 mm - 52 mm	0,555 kg	5	58,20 EUR
49-T-A	Ku-STA	Item number				Price
<p>The "Super Traction" screw extractor sets are used for extracting broken bolts and screws with right-hand threads. The screw extractors are an indispensable tool that neither hobby screwdrivers nor craftsmen professionals can do without.</p> 		49-T-A	4 - 20	0,11 kg	1	64,60 EUR
49-T	Ku-STA	Item number				Price
<p>The "Super Traction" screw extractor is used for extracting broken bolts and screws with right-hand threads. This makes the screw extractor an indispensable tool that neither hobby screwdrivers nor craftsmen can do without.</p> 		49-T-1	4 mm - 5 mm	0,01 kg	5	9,40 EUR
		49-T-2	5 mm - 7 mm	0,01 kg	5	9,40 EUR
		49-T-3	8 mm - 12 mm	0,015 kg	5	10,92 EUR
		49-T-4	12 mm - 14 mm	0,02 kg	1	13,60 EUR
		49-T-5	16 mm - 20 mm	0,044 kg	1	24,00 EUR

49-U-B	KU-STA	Item number				Price
<p>The screw extractor set with drills and drill guide is used for universal unscrewing of broken bolts and screws. The screw extractors are an indispensable tool that neither hobby screwdrivers nor craftsmen professionals can do without.</p> 		49-U-B	M5 - M16	0,85 kg	1	232,20 EUR







Spare parts > Spare parts > Drill

49-00	KU-STA	Item number				Price
<p>The twist drills are spare parts for the screw extractor with drill 49-U, which enable optimum machining of various materials.</p> 		49-0320	49-U-11, 49-U-12, 49-U-B	0,005 kg	1	40,00 EUR
		49-0480	49-U-12, 49-U-13, 49-U-14, 49-U-B	0,01 kg	1	40,00 EUR
		49-0640	49-U-13, 49-U-15, 49-U-B	0,015 kg	1	40,00 EUR
		49-0800	49-U-14, 49-U-B	0,03 kg	1	60,00 EUR
		49-0870	49-U-15, 49-U-B	0,04 kg	1	60,00 EUR
49-1152	KU-STA	Item number				Price
<p>The slip-on nuts are spare parts for the screw extractor with drills and drill bush of the 49-U series. They are available in sizes from 10 - 17 mm.</p> 		49-1152	49-U-11, 49-U-B	0,01 kg	1	24,00 EUR
		49-1252	49-U-12, 49-U-B	0,01 kg	1	24,00 EUR
		49-1352	49-U-13, 49-U-B	0,015 kg	1	24,00 EUR
		49-1452	49-U-14, 49-U-B	0,02 kg	1	24,00 EUR
		49-1552	49-U-15, 49-U-B	0,025 kg	1	60,00 EUR

Spare parts > Spare parts > Profile pin

49-1157	KU-STA	Item number				Price
<p>The profile pins are spare parts for the screw extractor with drills and drill bush of the 49-U series. They are available in sizes from 3.2 - 8.7 mm.</p> 		49-1157	49-U-11, 49-U-B	0,005 kg	1	24,00 EUR
		49-1257	49-U-12, 49-U-B	0,01 kg	1	24,00 EUR
		49-1357	49-U-13, 49-U-B	0,02 kg	1	24,00 EUR
		49-1457	49-U-14, 49-U-B	0,035 kg	1	24,00 EUR
		49-1557	49-U-15, 49-U-B	0,045 kg	1	60,00 EUR

Spare parts > Spare parts > Drill guide

49-27	KU-STA	Item number				Price
<p>The drill bushes are spare parts for the screw extractor with 49-U drills in various sizes, which enable fast and dimensionally accurate drilling.</p> 		49-27-A	49-U-11, 49-U-B	0,001 kg	1	24,00 EUR
		49-27-B	49-U-11, 49-U-B	0,01 kg	1	24,00 EUR
		49-27-C	49-U-12, 49-U-B	0,025 kg	1	24,00 EUR
		49-27-D	49-U-12, 49-U-B	0,25 kg	1	24,00 EUR
		49-27-E	49-U-13, 49-U-B	0,015 kg	1	24,00 EUR
		49-27-F	49-U-13, 49-U-B	0,015 kg	1	24,00 EUR
		49-27-G	49-U-14, 49-U-B	0,01 kg	1	24,00 EUR
		49-27-H	49-U-14, 49-U-B	0,025 kg	1	24,00 EUR
		49-27-I	49-U-15, 49-U-B	0,02 kg	1	24,00 EUR
		49-27-K	49-U-15, 49-U-B	0,025 kg	1	24,00 EUR
		<p>49-U</p> <p>The screw extractors with drills and drill bush are used for extracting broken bolts and screws. Thus the screw extractors are an indispensable tool that neither hobby screwdriver nor craftsman professional can do without.</p> 	<p>KU-STA</p>	Item number		
49-U-11	M5 - M7			0,03 kg	1	33,60 EUR
49-U-12	M8 - M9			0,055 kg	1	45,80 EUR
49-U-13	M10 -			0,085 kg	1	53,20 EUR
49-U-14	M12 -			0,125 kg	1	65,60 EUR
49-U-15	M14 - M16			0,16 kg	1	84,00 EUR

Grip / Hold > Screw clamps > Malleable cast iron screw clamps

490

TU_ZTG

Item number



Price

The VIRIDIS malleable cast iron screw clamps with wooden handle of the 490 series are used for pressing together and holding several workpieces. A high clamping force can be achieved due to the steel slide rail. With its round wooden handle, this series is a classic among screw clamps.





490-0100-050	100 mm / 50 mm	15 x 5	10	36,60 EUR
490-1500-120	1.500 mm / 120 mm	30 x 8	5	135,60 EUR
490-1250-120	1.250 mm / 120 mm	30 x 8	5	121,40 EUR
490-1000-120	1.000 mm / 120 mm	30 x 8	5	110,20 EUR
490-0800-120	800 mm / 120 mm	30 x 8	5	98,00 EUR
490-0600-120	600 mm / 120 mm	30 x 8	5	87,40 EUR
490-0500-120	500 mm / 120 mm	30 x 8	10	81,60 EUR
490-0400-120	400 mm / 120 mm	30 x 8	10	76,00 EUR
490-0300-120	300 mm / 120 mm	30 x 8	10	70,00 EUR
490-0300-140	300 mm / 140 mm	35 x 9	10	81,40 EUR
490-0400-140	400 mm / 140 mm	35 x 9	5	92,60 EUR
490-0800-175	800 mm / 175 mm	35 x 9	1	132,40 EUR
490-0600-175	600 mm / 175 mm	35 x 9	1	117,20 EUR
490-0500-175	500 mm / 175 mm	35 x 9	1	110,20 EUR
490-0400-175	400 mm / 175 mm	35 x 9	5	99,00 EUR
490-1000-140	1.000 mm / 140 mm	35 x 9	5	140,20 EUR
490-0800-140	800 mm / 140 mm	35 x 9	5	122,60 EUR
490-0600-140	600 mm / 140 mm	35 x 9	5	107,60 EUR
490-0500-140	500 mm / 140 mm	35 x 9	5	99,60 EUR
490-0250-120	250 mm / 120 mm	30 x 8	10	65,20 EUR
490-0200-120	200 mm / 120 mm	30 x 8	10	63,80 EUR
490-0200-080	200 mm / 80 mm	22 x 6	10	44,00 EUR
490-0160-080	160 mm / 80 mm	22 x 6	10	42,00 EUR
490-0120-080	120 mm / 80 mm	22 x 6	10	53,20 EUR
490-0300-065	300 mm / 65 mm	22 x 6	10	40,00 EUR
490-0200-065	200 mm / 65 mm	22 x 6	10	33,60 EUR







490

TU_ZTG

Item number				Price
490-0120-065	120 mm / 65 mm	22 x 6	10	32,40 EUR
490-0200-050	200 mm / 50 mm	15 x 5	10	32,60 EUR
490-0150-050	150 mm / 50 mm	15 x 5	10	32,60 EUR
490-0250-080	250 mm / 80 mm	22 x 6	10	40,80 EUR
490-0300-080	300 mm / 80 mm	22 x 6	10	43,00 EUR
490-0500-100	500 mm / 100 mm	30 x 8	10	71,80 EUR
490-0400-100	400 mm / 100 mm	30 x 8	10	68,80 EUR
490-0300-100	300 mm / 100 mm	30 x 8	10	62,60 EUR
490-0250-100	250 mm / 100 mm	30 x 8	10	60,00 EUR
490-0200-100	200 mm / 100 mm	30 x 8	10	60,00 EUR
490-0600-080	600 mm / 80 mm	22 x 6	10	55,00 EUR
490-0500-080	500 mm / 80 mm	22 x 6	10	50,80 EUR
490-0400-080	400 mm / 80 mm	22 x 6	10	45,80 EUR
490-1000-175	1.000 mm / 175 mm	35 x 9	1	148,20 EUR

Grip / Hold > Screw clamps > Heavy malleable cast iron clamps

493 TU_ZTG	Item number	 400 mm / 120 mm	 35 x 11	 1	Price
The malleable cast iron VIRIDIS screw clamps with wooden handle of the 493 series are used for pressing together and holding several workpieces. A high clamping force can be achieved due to the steel slide rail. With its round wooden handle, this series is a classic among screw clamps. 	493-0400-120	400 mm / 120 mm	35 x 11	1	91,80 EUR
	493-2500-120	2.500 mm / 120 mm	35 x 11	1	239,00 EUR
	493-2200-120	2.200 mm / 120 mm	35 x 11	1	196,20 EUR
	493-2000-120	2.000 mm / 120 mm	35 x 11	1	196,80 EUR
	493-1800-120	1.800 mm / 120 mm	35 x 11	1	174,20 EUR
	493-1500-120	1.500 mm / 120 mm	35 x 11	1	161,20 EUR
	493-1250-120	1.250 mm / 120 mm	35 x 11	1	147,00 EUR
	493-1000-120	1.000 mm / 120 mm	35 x 11	1	135,00 EUR
	493-0800-120	800 mm / 120 mm	35 x 11	1	120,60 EUR
	493-0600-120	600 mm / 120 mm	35 x 11	1	106,60 EUR
	493-0500-120	500 mm / 120 mm	35 x 11	1	100,20 EUR
	493-3000-120	3.000 mm / 120 mm	35 x 11	1	283,80 EUR











490P

TU_ZTG

The VIRIDIS malleable cast iron screw clamps with 2K comfort grip of the 490P series are used for pressing together and holding several workpieces. A high clamping force can be achieved due to the steel slide rail. The 490P series is equipped with a 2-component handle.





Item number				Price
490P0100-050 NEW	100 mm / 50 mm	15 x 5	1	66,60 EUR
490P0150-050 NEW	150 mm / 50 mm	15 x 5	1	38,20 EUR
490P0200-050 NEW	200 mm / 50 mm	15 x 5	1	38,20 EUR
490P0120-065 NEW	120 mm / 65 mm	22 x 6	1	48,40 EUR
490P0200-065 NEW	200 mm / 65 mm	22 x 6	1	41,60 EUR
490P0300-065 NEW	300 mm / 65 mm	22 x 6	1	44,20 EUR
490P0160-080 NEW	160 mm / 80 mm	22 x 6	1	54,60 EUR
490P0200-080 NEW	200 mm / 80 mm	22 x 6	1	45,20 EUR
490P0250-080 NEW	250 mm / 80 mm	22 x 6	1	46,60 EUR
490P0300-080 NEW	300 mm / 80 mm	22 x 6	1	49,00 EUR
490P0400-080 NEW	400 mm / 80 mm	22 x 6	1	53,00 EUR
490P0200-100 NEW	200 mm / 100 mm	30 x 8	1	61,60 EUR
490P0250-100 NEW	250 mm / 100 mm	30 x 8	1	67,80 EUR
490P0300-100 NEW	300 mm / 100 mm	30 x 8	1	72,20 EUR
490P0400-100 NEW	400 mm / 100 mm	30 x 8	1	78,60 EUR
490P0500-100 NEW	500 mm / 100 mm	30 x 8	1	81,40 EUR
490P0250-120 NEW	250 mm / 120 mm	30 x 8	1	74,80 EUR
490P0300-120 NEW	300 mm / 120 mm	30 x 8	1	80,60 EUR
490P0400-120 NEW	400 mm / 120 mm	30 x 8	1	87,00 EUR
490P0500-120 NEW	500 mm / 120 mm	30 x 8	1	93,80 EUR
490P0600-120 NEW	600 mm / 120 mm	30 x 8	1	99,80 EUR
490P0800-120 NEW	800 mm / 120 mm	30 x 8	1	110,80 EUR
490P1000-120 NEW	1.000 mm / 120 mm	30 x 8	1	124,40 EUR
490P0300-140 NEW	300 mm / 140 mm	35 x 9	1	93,80 EUR
490P0400-140 NEW	400 mm / 140 mm	35 x 9	1	105,00 EUR
490P0500-140 NEW	500 mm / 140 mm	35 x 9	1	113,80 EUR
490P0600-140 NEW	600 mm / 140 mm	35 x 9	1	121,80 EUR
490P0800-140 NEW	800 mm / 140 mm	35 x 9	1	138,20 EUR

490P	TU_ZTG	Item number				Price
		490P1000-140 NEW	1.000 mm / 140 mm	35 x 9	1	158,20 EUR
		490P0400-175 NEW	400 mm / 175 mm	35 x 9	1	113,00 EUR
		490P0500-175 NEW	500 mm / 175 mm	35 x 9	1	124,80 EUR
		490P0600-175 NEW	600 mm / 175 mm	35 x 9	1	132,40 EUR
		490P0800-175 NEW	800 mm / 175 mm	35 x 9	1	149,80 EUR
		490P1000-175 NEW	1.000 mm / 175 mm	35 x 9	1	166,20 EUR
493P	TU_ZTG	Item number				Price
<p>The malleable cast iron VIRIDIS screw clamps with 2K comfort grip of the 493P series are used for pressing together and holding several workpieces. A high clamping force can be achieved due to the steel slide rail. The 493P series is equipped with a 2-component handle.</p> 		493P0400-120 NEW	400 mm / 120 mm	35 x 11	1	104,60 EUR
		493P0500-120 NEW	500 mm / 120 mm	35 x 11	1	114,40 EUR
		493P0600-120 NEW	600 mm / 120 mm	35 x 11	1	121,40 EUR
		493P0800-120 NEW	800 mm / 120 mm	35 x 11	1	136,60 EUR
		493P1000-120 NEW	1.000 mm / 120 mm	35 x 11	1	151,80 EUR
		493P1250-120 NEW	1.250 mm / 120 mm	35 x 11	1	165,80 EUR
		493P1500-120 NEW	1.500 mm / 120 mm	35 x 11	1	181,40 EUR
		493P1800-120 NEW	1.800 mm / 120 mm	35 x 11	1	195,20 EUR
		493P2000-120 NEW	2.000 mm / 120 mm	35 x 11	1	221,20 EUR
		493P2200-120 NEW	2.200 mm / 120 mm	35 x 11	1	220,00 EUR
		493P2500-120 NEW	2.500 mm / 120 mm	35 x 11	1	267,00 EUR
		493P3000-120 NEW	3.000 mm / 120 mm	35 x 11	1	316,20 EUR

490K
TU_ZTG

The malleable cast iron screw clamps VIRIDIS with steel toggle handle of the 490K series are used for pressing together and holding several workpieces. The steel sliding rail allows a high clamping force to be achieved. The 490K series has a toggle handle for particularly firm tightening.





Item number				Price
490K0160-080	160 mm / 80 mm	22 x 6	1	40,40 EUR
490K0200-100	200 mm / 100 mm	30 x 8	1	55,80 EUR
490K0250-120	250 mm / 120 mm	30 x 8	1	68,00 EUR
490K0300-120	300 mm / 120 mm	30 x 8	1	73,20 EUR
490K0400-120	400 mm / 120 mm	30 x 8	1	79,00 EUR
490K0500-120	500 mm / 120 mm	30 x 8	1	84,40 EUR
490K0600-120	600 mm / 120 mm	30 x 8	1	90,60 EUR
490K0800-120	800 mm / 120 mm	30 x 8	1	95,20 EUR
490K1000-120	1.000 mm / 120 mm	30 x 8	1	106,60 EUR
490K0300-140	300 mm / 140 mm	35 x 9	1	85,60 EUR
490K0400-175	400 mm / 175 mm	35 x 9	1	103,00 EUR



493K
TU_ZTG





The malleable cast iron VIRIDIS screw jack with steel toggle handle of the 493K series is used for pressing together and holding several workpieces. A high clamping force can be achieved due to the steel sliding rail. The 493K series has a toggle handle for particularly firm tightening.











Item number				Price
493K0400-120	400 mm / 120 mm	35 x 11	1	93,20 EUR
493K2500-120	2.500 mm / 120 mm	35 x 11	1	242,40 EUR
493K2000-120	2.000 mm / 120 mm	35 x 11	1	200,80 EUR
493K1500-120	1.500 mm / 120 mm	35 x 11	1	165,00 EUR
493K1250-120	1.250 mm / 120 mm	35 x 11	1	144,60 EUR
493K1000-120	1.000 mm / 120 mm	35 x 11	1	138,60 EUR
493K0800-120	800 mm / 120 mm	35 x 11	1	119,60 EUR
493K0600-120	600 mm / 120 mm	35 x 11	1	107,60 EUR
493K0500-120	500 mm / 120 mm	35 x 11	1	103,80 EUR
493K3000-120	3.000 mm / 120 mm	35 x 11	1	287,40 EUR

Grip / Hold > Screw clamps > Deep-clamping die-cast clamp

505/509	TU_ZTG	Item number				Price	
<p>The deep clamping tempered cast iron screw clamps with wooden handle are used for pressing together and holding large workpieces. A high clamping force can be achieved due to the steel slide rail. With their round wooden handle, these series are classics among screw clamps.</p> 		505-040	400 mm / 200 mm	35 x 11	1	148,00 EUR	
		507-100	1.000 mm / 300 mm	45 x 12	1	281,40 EUR	
		507-080	800 mm / 300 mm	45 x 12	1	255,20 EUR	
		507-060	600 mm / 300 mm	45 x 12	1	238,40 EUR	
		507-040	400 mm / 300 mm	45 x 12	1	211,80 EUR	
		506-100	1.000 mm / 250 mm	45 x 12	1	261,40 EUR	
		506-080	800 mm / 250 mm	45 x 12	1	224,40 EUR	
		506-060	600 mm / 250 mm	45 x 12	1	205,00 EUR	
		506-040	400 mm / 250 mm	45 x 12	1	319,80 EUR	
		505-100	1.000 mm / 200 mm	35 x 11	1	200,80 EUR	
		505-080	800 mm / 200 mm	35 x 11	1	180,60 EUR	
		505-060	600 mm / 200 mm	35 x 11	1	169,80 EUR	
	505P/507P	TU_ZGZ	Item number				Price
	<p>The deep clamping tempered cast iron screw clamps with 2K comfort grip of the 505P to 509P series are used for pressing together and holding large workpieces. A high clamping force can be achieved due to the steel slide rail. The series are equipped with a 2-component handle.</p> 		505P040 NEW	400 mm / 200 mm	35 x 11	1	163,80 EUR
		507P100 NEW	1.000 mm / 300 mm	45 x 12	1	317,40 EUR	
		507P080 NEW	800 mm / 300 mm	45 x 12	1	289,20 EUR	
		507P060 NEW	600 mm / 300 mm	45 x 12	1	268,40 EUR	
		507P040 NEW	400 mm / 300 mm	45 x 12	1	239,40 EUR	
		506P100 NEW	1.000 mm / 250 mm	45 x 12	1	277,00 EUR	
		506P080 NEW	800 mm / 250 mm	45 x 12	1	255,80 EUR	
		506P060 NEW	600 mm / 250 mm	45 x 12	1	233,20 EUR	
		506P040 NEW	400 mm / 250 mm	45 x 12	1	206,40 EUR	
		505P100 NEW	1.000 mm / 200 mm	35 x 11	1	228,00 EUR	
		505P080 NEW	800 mm / 200 mm	35 x 11	1	206,00 EUR	
		505P060 NEW	600 mm / 200 mm	35 x 11	1	185,20 EUR	

505K/509K	TU_ZTG	Item number				Price
<p>The deep clamping tempered cast iron screw clamps with steel toggle handle of the 505K to 509K series are used for pressing together and holding large workpieces. A high clamping force is achieved due to the steel sliding rail. The series have a toggle handle for particularly firm tightening.</p> 		505K040	400 mm / 200 mm	35 x 11	1	152,00 EUR
		507K100	1.000 mm / 300 mm	45 x 12	1	292,00 EUR
		507K080	800 mm / 300 mm	45 x 12	1	266,20 EUR
		507K060	600 mm / 300 mm	45 x 12	1	247,00 EUR
		507K040	400 mm / 300 mm	45 x 12	1	221,20 EUR
		506K100	1.000 mm / 250 mm	45 x 12	1	254,80 EUR
		506K080	800 mm / 250 mm	45 x 12	1	234,00 EUR
		506K060	600 mm / 250 mm	45 x 12	1	214,60 EUR
		506K040	400 mm / 250 mm	45 x 12	1	190,20 EUR
		505K100	1.000 mm / 200 mm	35 x 11	1	210,80 EUR
		505K080	800 mm / 200 mm	35 x 11	1	190,20 EUR
		505K060	600 mm / 200 mm	35 x 11	1	171,40 EUR

Grip / Hold > Forcing in general > Glue clamps



511	KU-STA	Item number				Price
		511-200	200 mm		10	27,30 EUR
		511-300	300 mm		10	28,98 EUR
		511-400	400 mm		1	30,38 EUR
		511-600	600 mm		10	32,62 EUR
		511-800	800 mm		5	38,92 EUR
516	KU-STA	Item number				Price
<p>The glue clamps of the 516 series are used to hold several workpieces in crafts, industry and workshops. The glue clamps are equipped with a strong spring and vulcanised fibre plate coating to ensure powerful and handy holding.</p> 		516-110	110 mm	40 mm	10	14,98 EUR
		516-155	155 mm	50 mm	10	20,00 EUR

516-200	KU_STA	Item number				Price
<p>The glue gun clamps of the 516 series are used to hold several workpieces in crafts, industry and workshops. The glue gun clamps are equipped with a strong spring and high-quality plastic to ensure powerful and handy holding.</p> 		516-200 NEW	180 mm	50 mm	10	52,00 EUR
		516-300 NEW	240 mm	75 mm	10	61,60 EUR





Grip / Hold > Forcing in general > One-handed clamping and expanding clamps

517	KU_STA	Item number				Price
<p>The 517 series one-handed clamp is used to press together and hold several workpieces. The one-handed clamp is mainly used in the woodworking sector. The one-handed operation ensures maximum flexibility. The protective caps guarantee gentle handling of the workpiece.</p> 		517-150K	150 mm / 85 mm	19 x 6	1	34,40 EUR
		517-300K	300 mm / 85 mm	19 x 6	1	39,00 EUR
		517-450K	450 mm / 85 mm	19 x 6	1	41,60 EUR
		517-600K	600 mm / 85 mm	19 x 6	1	47,00 EUR









Grip / Hold > Grip / Hold > Vices







520	TU_RES	Item number				Price
<p>The all-steel vices of the 520 series are used for clamping workpieces. The lightweight design of the 520 series is ideal for universal clamping of simple workpieces and the material ensures the necessary durability and stability of the vice.</p> 		520-080	80 mm	100 mm	1	171,00 EUR
		520-100	100 mm	120 mm	1	220,80 EUR
		520-125	125 mm	140 mm	1	273,80 EUR
		520-150	150 mm	155 mm	1	361,60 EUR
		520-175	175 mm	155 mm	1	434,80 EUR
		520-100-R	100 mm	120 mm	1	231,60 EUR
		520-125-R	125 mm	140 mm	1	284,80 EUR
		520-150-R	150 mm	155 mm	1	372,60 EUR
		520-175-R	175 mm	155 mm	1	446,00 EUR
		520-100-G	100 mm	120 mm	1	231,60 EUR
		520-125-G	125 mm	140 mm	1	284,80 EUR
		520-150-G	150 mm	155 mm	1	372,60 EUR
		520-175-G	175 mm	155 mm	1	446,00 EUR
525	TU_RES	Item number				Price
<p>The parallel vices of the 525 series are used for clamping workpieces. The induction-hardened parts make the 525 series ideal for universal clamping of medium-sized workpieces and the material ensures the necessary durability of the vice.</p> 		525-100	100 mm	125 mm	1	343,60 EUR
		525-125	125 mm	150 mm	1	428,00 EUR
		525-150	150 mm	200 mm	1	551,00 EUR
		525-175	175 mm	220 mm	1	778,40 EUR
		525-100-R	100 mm	125 mm	1	355,00 EUR
		525-125-R	125 mm	150 mm	1	438,80 EUR
		525-150-R	150 mm	200 mm	1	561,20 EUR
		525-175-R	175 mm	220 mm	1	789,80 EUR
		525-100-G	100 mm	125 mm	1	354,40 EUR
		525-125-G	125 mm	150 mm	1	438,80 EUR
		525-150-G	150 mm	200 mm	1	561,20 EUR
		525-175-G	175 mm	220 mm	1	789,80 EUR



Spare parts > Spare parts > Vice jaws

525-1	TU_RES	Item number				Price
<p>The interchangeable pipe clamping jaws, in combination with the parallel vices of the 525 series, enable the clamping of round workpieces in crafts, industry and workshops. Especially for plumbers, locksmiths and mechanics, the pipe clamping jaws are a useful accessory.</p> 		525-101	525-100	0,335 kg	1	55,40 EUR
		525-126	525-125	0,43 kg	1	55,40 EUR
		525-151	525-150	0,875 kg	1	65,60 EUR
		525-176	525-175	5,2 kg	1	65,60 EUR



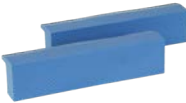



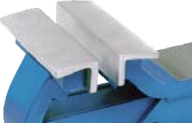

Spare parts > Spare parts > Turntable



525-102	TU_RES	Item number				Price
<p>The swivel plates are spare parts for vices that allow the individual alignment of the vice during use, making the machining of workpieces much easier.</p> 		525-102	525-100	5,2 kg	1	100,20 EUR
		525-127	525-125	2,43 kg	1	129,20 EUR
		525-152	525-150	2,825 kg	1	171,40 EUR
		525-177	525-175	4,09 kg	1	209,40 EUR
545F	TU_RES	Item number				Price
		545F100	525-100, 520-100, 520-100-R, 520-100-G, 525-100-R, 525-100-G	0,18 kg	1	51,20 EUR
		545F125	520-125, 520-125-R, 520-125-G, 525-125, 525-125-R, 525-125-G	0,205 kg	1	57,60 EUR
		545F150	520-150, 520-150-R, 520-150-G, 525-150, 525-150-R, 525-150-G	0,24 kg	1	61,00 EUR
		545F180		0,4 kg	1	61,60 EUR

545G TU_RES	Item number				Price
<p>Made of aluminium and grey rubber, the vice jaws with magnetic strips can be used together with the 520, 525 and 530 series to make them more durable and robust. The rubber provides extra slip resistance, which means that even stainless steel workpieces or thin-walled pipes can be clamped without deforming.</p> 	545G100	525-100, 520-100, 520-100-R, 520-100-G, 525-100-R, 525-100-G	0,18 kg	1	51,20 EUR
	545G125	520-125, 520-125-R, 520-125-G, 525-125, 525-125-R, 525-125-G	0,215 kg	1	53,20 EUR
	545G150	520-150, 520-150-R, 520-150-G, 525-150, 525-150-R, 525-150-G	0,26 kg	1	55,40 EUR
	545G180		0,295 kg	1	56,80 EUR
545K TU_RES	Item number				Price
<p>The blue plastic vice jaws with magnetic strips can be combined with the 520, 525 and 530 series to make them more durable and robust.</p> 	545K125	520-125, 520-125-R, 520-125-G, 525-125, 525-125-R, 525-125-G	0,18 kg	1	53,20 EUR
	545K140		0,2 kg	1	55,00 EUR
	545K150	520-150, 520-150-R, 520-150-G, 525-150, 525-150-R, 525-150-G	0,205 kg	1	55,40 EUR

550	TU_RES	Item number				Price
<p>The aluminium vice jaws can be combined with the 520, 525 and 530 series to make them more durable and robust.</p> 		550-080	520-080	0,22 kg	5	52,20 EUR
		550-100	525-100, 520-100, 520-100-R, 520-100-G, 525-100-R, 525-100-G	0,36 kg	5	51,60 EUR
		550-115		0,81 kg	5	58,00 EUR
		550-125	520-125, 520-125-R, 520-125-G, 525-125, 525-125-R, 525-125-G	0,435 kg	5	57,60 EUR
		550-135		0,475 kg	5	61,00 EUR
		550-150	520-150, 520-150-R, 520-150-G, 525-150, 525-150-R, 525-150-G	0,525 kg	5	62,60 EUR
		550-180		0,61 kg	5	65,20 EUR

Pulling > Removing > Stud extractor

50	Ku-STA	Item number		SW 		Price
<p>The Series 50 stud extractor with internal teeth is used for removing stud bolts or torn components in the automotive and industrial sectors. They are available in various sizes and impress with their particularly proven and powerful design, especially under high loads.</p> 		50-1	5 - 10	17	1	91,60 EUR
		50-2	8 - 19	27	1	124,20 EUR
		50-3	18 - 25	36	1	139,60 EUR
51	Ku-STA	Item number		SW 		Price
<p>The Series 51 stud extractor with internal teeth is used to unscrew stud bolts or torn components in the automotive and industrial sectors. Stud extractors are available in various diameters. The 51 series impresses with its handy and inexpensive design.</p> 		51-1	5 - 10	19	1	91,60 EUR
		51-2	8 - 19	19	1	139,60 EUR
		51-3	18 - 25	19	1	165,40 EUR

52	Ku-STA	Item number		SW 		Price
<p>The Series 52 stud extractor with internal teeth is used to extract stud bolts or torn components in the automotive and industrial sectors. Compared to other models, the 52 series has a large clamping range and therefore also enables short stud bolt ends to be gripped.</p> 	52	5 - 19	19	1	227,60 EUR	
53-A	Ku-STA	Item number		SW 		Price
<p>The stud extractor set is used for extracting stud bolts or broken components in automotive and industrial applications. Due to its design, the 53 series can also be used in the tightest of spaces and is operated by means of a ring spanner or socket spanner.</p> 	53-A	6; 8; 10; 12mm	21	1	313,00 EUR	
53	Ku-STA	Item number		SW 		Price
<p>The Series 53 stud extractor with internal teeth is used to unscrew stud bolts or torn components in the automotive and industrial sectors. Thanks to their design, they can also be used in the tightest of spaces and are operated using a ring spanner or socket spanner.</p> 	53-5	5	21	1	95,20 EUR	
	53-6	6	21	1	95,20 EUR	
	53-7	7	21	1	95,20 EUR	
	53-8	8	21	1	95,20 EUR	
	53-10	10	21	1	95,20 EUR	
	53-12	12	21	1	95,20 EUR	
	53-14	14	24	1	110,20 EUR	
	53-16	16	24	1	148,20 EUR	
	53-18	18	36	1	723,60 EUR	
	53-20	20	36	1	723,60 EUR	
	53-22	22	36	1	723,60 EUR	
	53-24	24	36	1	723,60 EUR	
53-30	30	46	1	966,60 EUR		



Storage / Presentation > Suitcase > K-Cutting / Loosening

K-54-B	Ku-STA	Item number				Price
<p>The 6-piece mechanical nut blaster set is used to blast undetachably stuck, rusted or over-tightened nuts of grades 5, 6 and 8. The two sharp cutting edges of the chisel penetrate deep into the nut when the spindle is tightened until it is blasted.</p> 	K-54-B	54-2, 54-3, 54-2-M, 54-3-M	2,015 kg	1	470,40 EUR	

Cutting / loosening > Cutting / loosening > Nut splitter

54	Ku-STA	Item number				Price
<p>The double-edged, mechanical nut blaster is used to blast undetachably stuck, rusted or over-tightened nuts of grades 5, 6 and 8. The two sharp cutting edges of the bit penetrate deep into the nut when the spindle is tightened until it is blasted.</p> 	54-2	10 mm - 27 mm	0,48 kg	1	142,20 EUR	
	54-3	17 mm - 36 mm	0,72 kg	1	185,20 EUR	

Spare parts > Spare parts > Blasting chisel

54-M	KU-STA	Item number				Price
<p>The blasting chisels are spare parts for double-edged, mechanical nut splitters of the 54 series. The hardened cutting edges of the chisels ensure that nuts can be blasted in a single operation.</p> 		54-2-M	54-2	0,06 kg	1	80,00 EUR
		54-3-M	54-3	0,1 kg	1	80,00 EUR
K-55-B	Ku-STA	Item number				Price
<p>The 7-piece mechanical nut blaster set is used to blast stuck, rusted or over-tightened grade 6 nuts. The two sharp cutting edges of the chisel penetrate deep into the nut when the spindle is tightened until it is blasted.</p> 		K-55-B	97-1, 55-1, 55-2, 55-3	2,015 kg	1	511,70 EUR
55	Ku-STA	Item number				Price
<p>The single-edged, mechanical nut blaster is used to blast stuck, rusted or over-tightened grade 6 nuts. The cutting edge of the chisel, which is sharp due to a facet grind, penetrates deep into the nut when the spindle is tightened until it is blasted.</p> 		55-0	4 mm - 10 mm	0,1 kg	1	98,20 EUR
		55-1	10 mm - 18 mm	0,22 kg	1	118,20 EUR
		55-2	19 mm - 27 mm	0,435 kg	1	128,00 EUR
		55-3	27 mm - 36 mm	0,66 kg	1	165,00 EUR
		55-4	32 mm - 50 mm	2,55 kg	1	551,00 EUR
K-55-B	Ku-STA	Item number				Price
<p>The 7-piece mechanical nut blaster set is used to blast stuck, rusted or over-tightened grade 6 nuts. The two sharp cutting edges of the chisel penetrate deep into the nut when the spindle is tightened until it is blasted.</p> 		K-55-B	97-1, 55-1, 55-2, 55-3	2,015 kg	1	511,70 EUR
55-06	KU-STA	Item number				Price
<p>The spindle with plaster is a spare part for single-bladed, mechanical nut splitters of the 55 series.</p> 		55-0-06	55-0	0 kg	1	40,00 EUR

55-M	KU-STA	Item number				Price
<p>The blasting bits are spare parts for single-bladed, mechanical nut splitters of the 55 series. The hardened cutting edges of the bits ensure the blasting of nuts by facet grinding.</p> 		55-0-M	55-0	0,015 kg	1	60,00 EUR
		55-1-M	55-1	0,025 kg	1	60,00 EUR
		55-2-M	55-2	0,05 kg	1	80,00 EUR
		55-3-M	55-3	0,07 kg	1	80,00 EUR
		55-4-M	55-4	0,305 kg	1	120,00 EUR

56	KU-STA	Item number				Price
<p>The single-bladed, grease-hydraulic nut blaster is used for blasting particularly large, stuck, rusted or over-tightened nuts of grades 5, 6, 8 and 10. Thanks to the grease hydraulics, only a small amount of force is required.</p> 		56-1	7 mm - 24 mm	0,86 kg	1	315,20 EUR
		56-2	22 mm - 36 mm	2,865 kg	1	582,60 EUR
		56-3	27 mm - 46 mm	6,6 kg	1	851,40 EUR













56-M	KU-STA	Item number				Price
<p>The blasting chisels are spare parts for single-edged, grease-hydraulic nut splitters of series 56. The very sharp chisel cutting edges ensure the blasting of nuts by facet grinding (spare part is coloured green).</p> 		56-1-M	56-1	0,025 kg	1	60,00 EUR
		56-2-M	56-2	0,305 kg	1	80,00 EUR
		56-3-M	56-3	0,245 kg	1	160,00 EUR

56-ERS	KU-STA	Item number				Price
<p>The wearing parts kits for nut splitters are used to replace worn parts of the single-blade, grease-hydraulic nut splitters of the 56 series.</p> 		56-1ERS	56-1	0,3 kg	1	160,00 EUR
		56-2ERS	56-2	0,72 kg	1	320,00 EUR

Cutting / loosening > Cutting / loosening > Thread repair

K-58	KU-STA	Item number	Stück pieces			Price
<p>The thread repair kit is used for the cost-effective and professional restoration of heavy-duty screw connections in the case of torn-out internal threads as well as the repair of defective and over-tightened threads on all oil pans and oil drain plugs.</p> 		K-58-M05-M10	60	2,07 kg	1	1.059,00 EUR

Spare parts > Spare parts > Thread repair spare parts

58-ES	KU-STA	Item number				Price
<p>The seat milling cutters are spare parts for the KUKKO Thread Repair set of series 58. The seat milling cutters are available for different thread sizes.</p> 		58-M03x05-2-E	K-58-M05-M10	0,02 kg	1	60,00 EUR
		58-M04x07-2-E	K-58-M05-M10	0,02 kg	1	60,00 EUR
		58-M05x08-2-E	K-58-M05-M10	0,02 kg	1	60,00 EUR
		58-M06x10-2-E	K-58-M05-M10	0,02 kg	1	60,00 EUR
		58-M07x10-2-E	K-58-M05-M10	0,04 kg	1	60,00 EUR
		58-M08x125-2-E	K-58-M05-M10	0,02 kg	1	65,20 EUR
58-E	KU-STA	Item number				Price
<p>The insertion tools are spare parts for the KUKKO Thread Repair set of series 58. The insertion tools are available for different thread sizes.</p> 		58-M03x05-4-E	K-58-M05-M10	0,02 kg	1	80,00 EUR
		58-M04x07-4-E	K-58-M05-M10	0,02 kg	1	80,00 EUR
		58-M05x08-4-E	K-58-M05-M10	0,02 kg	1	48,80 EUR
		58-M06x10-4-E	K-58-M05-M10	0,02 kg	1	80,00 EUR
		58-M07x10-4-E	K-58-M05-M10	0,02 kg	1	80,00 EUR
		58-M08x125-4-E	K-58-M05-M10	0,02 kg	1	48,80 EUR
58-S/5	Ku-STA	Item number				Price
<p>The bushing sets are spare parts for the KUKKO Thread Repair set of series 58. The bushing sets are available for different thread sizes.</p> 		58-M05x08x100-S/5	K-58-M05-M10	0,02 kg	1	51,00 EUR
		58-M05x08x76-S/5	K-58-M05-M10	0,02 kg	1	51,00 EUR
		58-M06x10x120-S/5	K-58-M05-M10	0,025 kg	1	51,00 EUR
		58-M06x10x94-S/5	K-58-M05-M10	0,02 kg	1	51,00 EUR
		58-M08x10x117-S/5	K-58-M05-M10	0,7 kg	1	64,00 EUR
		58-M08x125x117-S/5	K-58-M05-M10	0,025 kg	1	64,00 EUR
		58-M08x125x162-S/5	K-58-M05-M10	0,035 kg	1	64,00 EUR
		58-M10x10x150-S/5	K-58-M05-M10	0 kg	1	64,00 EUR
		58-M10x125x140-S/5	K-58-M05-M10	0,025 kg	1	64,00 EUR
		58-M10x125x200-S/5	K-58-M05-M10	0,035 kg	1	64,00 EUR
		58-M10x150x140-S/5	K-58-M05-M10	0,03 kg	1	64,00 EUR
		58-M10x150x200-S/5	K-58-M05-M10	0,06 kg	1	64,00 EUR

58-1-E	KU-STA	Item number				Price
<p>The twist drills for thread repair are spare parts for the KUKKO thread repair set K-58, which are used for machining various workpieces. The twist drills are available in various standard sizes.</p>		58-M03x05-1-E	K-58-M05-M10	0 kg	1	46,60 EUR
		58-M04x07-1-E	K-58-M05-M10	0 kg	1	46,60 EUR
		58-M05x08-1-E	K-58-M05-M10	0 kg	1	46,60 EUR
		58-M06x10-1-E	K-58-M05-M10	0,1 kg	1	80,00 EUR
		58-M07x10-1-E	K-58-M05-M10	0 kg	1	46,60 EUR
		58-M08x10-1-E	K-58-M05-M10	0 kg	1	46,60 EUR

Grip / Hold > Grip / Hold > Chain tensioner

59	Ku-STA	Item number				Price
<p>The chain tensioner set of the K-59 series is used to separate, tension and rivet chains on motorbikes. With this set, chains can not only be safely separated, but also accurately riveted again thanks to a crimping aid.</p>		K-59-1/14	9 mm - 46 mm	2,465 kg	1	652,20 EUR
		58-1	KU-STA	Item number		
		58-1	9 mm - 46 mm	0,17 kg	1	160,00 EUR
59-1	KU-STA	Item number				Price
		59-1	3,28 - 5,72	0,924 kg	1	520,00 EUR
59-1-1	KU-STA	Item number				Price
<p>The small set for the 59 series chain sprinkler base unit is a spare parts set that provides essential elements for the use of the base unit.</p>		59-1-1	3,28 - 4,45	0,13 kg	1	80,00 EUR
		59-1-2	5,08 - 5,72	0,19 kg	1	120,00 EUR

600000

KU-STA

Item number



Price

The mechanical pressure spindles are spare parts for KUKKO extractors and, thanks to their special coating, guarantee particularly good sliding properties in the thread. The bearing-mounted, free-turning centre point protects the shaft from damage when applying the extraction force.



Item number					Price
600648			0,02 kg	1	80,00 EUR
609090	110-01, 110-02		0 kg	1	40,00 EUR
610060	128-F-60, 128-F-SW		0,06 kg	1	80,00 EUR
610145	27-A, 69-A		0,11 kg	1	60,00 EUR
610075	800		0,085 kg	1	40,00 EUR
610180	70-1		0,16 kg	1	60,00 EUR
612075	801, 802, 804		0,125 kg	1	60,00 EUR
614048	129-1		0,09 kg	1	60,00 EUR
614042	128-1		0,075 kg	1	40,00 EUR
614051	118-0, 118-1		0,9 kg	1	40,00 EUR
616038	129-2		0,145 kg	1	60,00 EUR
616056	128-2		0,11 kg	1	60,00 EUR
616160	14-2		0,265 kg	1	80,00 EUR
618290	70-3		0,6 kg	1	120,00 EUR
621245	41-5		0,665 kg	1	120,00 EUR
623100			0,515 kg	1	120,00 EUR
623110	204-44		0,44 kg	1	80,00 EUR
626130	129-6		0,62 kg	1	160,00 EUR
626173			1,21 kg	1	160,00 EUR
626181	38, 40-3, 40-5		1,105 kg	1	80,00 EUR

Optional extensions > Accessories > Mechanical spindles

6

KU-STA

Item number







Price

The mechanical pressure spindle is the heart of every KUKKO puller. This allows a maximum pulling force of 10 t to be achieved. Manual operation of the spindle ensures sensitive control of the pulling process. The fine thread also guarantees perfect power transmission.







608080	80 mm	M 8x1,25	1	40,00 EUR
608130	130 mm	M 8x1,25	1	40,00 EUR
609087	87 mm	M 9x1,25	1	40,00 EUR
609105	105 mm	M 9x1,25	1	40,00 EUR
610070	75 mm	M 10x1,5	1	40,00 EUR
610094	94 mm	M 10x1,5	1	60,00 EUR
610110	120 mm	M 10x1,5	1	60,00 EUR
610120	120 mm	M 10x1,5	1	80,00 EUR
612080	85 mm	M 12x1,5	1	60,00 EUR
612110	110 mm	M 12x1,5	1	60,00 EUR
612130	130 mm	M 12x1,5	1	60,00 EUR
612150	150 mm	M 12x1,5	1	60,00 EUR
612200	210 mm	M 12x1,75	1	60,00 EUR
614135	135 mm	M 14x1,5	1	80,00 EUR
614160	160 mm	M 14x1,5	1	80,00 EUR
614200	200 mm	M 14x1,5	1	80,00 EUR
614242	240 mm	M 14x1,5	1	120,00 EUR
614250	250 mm	M 14x1,5	1	80,00 EUR
616202	185 mm	M 16x2,0	1	80,00 EUR
616270	270 mm	M 16x2,0	1	118,60 EUR
616325	325 mm	M 16x2,0	1	80,00 EUR
616220	220 mm	M 16x1,5	1	80,00 EUR
618068	58 mm	M 18x1,5	1	60,00 EUR
618105	105 mm	M 18x1,5	1	60,00 EUR
618175	175 mm	M 18x1,5	1	80,00 EUR
618210	210 mm	M 18x1,5	1	80,00 EUR
620172	170 mm	M 20x2,5	1	160,00 EUR
621130	130 mm	G 1/2" / 14	1	80,00 EUR
621170	170 mm	G 1/2" / 14	1	120,00 EUR
621220	220 mm	G 1/2" / 14	1	120,00 EUR
621300	300 mm	G 1/2" / 14	1	120,00 EUR
621355	355 mm	G 1/2" / 14	1	160,00 EUR
623150	150 mm	G 5/8" / 14	1	120,00 EUR
623170	170 mm	G 5/8" / 14	1	120,00 EUR
623230	230 mm	G 5/8" / 14	1	160,00 EUR
623260	260 mm	G 5/8" / 14	1	160,00 EUR
623325	325 mm	G 5/8" / 14	1	160,00 EUR
623360	360 mm	G 5/8" / 14	1	160,00 EUR
623450	450 mm	G 5/8" / 14	1	320,00 EUR
626300	300 mm	G 3/4" / 14	1	160,00 EUR
626400	400 mm	G 3/4" / 14	1	320,00 EUR
626500	500 mm	G 3/4" / 14	1	546,00 EUR
633400	400 mm	G 1" / 11	1	320,00 EUR
633500	500 mm	G 1" / 11	1	520,00 EUR
633600	600 mm	G 1"	1	760,00 EUR
637350	350 mm	G1" 1/8	1	520,00 EUR
637500	500 mm	G1" 1/8	1	760,00 EUR
637600	600 mm	1.1/8"	1	760,00 EUR
638300	322 mm	W 1.1/2"	1	320,00 EUR





611116	KU-STA	Item number				Price
<p>The set screw is a spare part for the Y-221-E internal extractor of the Y-21 series. Together with the extractors of the Y-180 series, stuck parts can be extracted hydraulically and precisely.</p> 		611116	818-215, 845-858, Y-221-E	0,305 kg	1	200,00 EUR



Spare parts > Spare parts > Spindle tip





612140 KU-STA	Item number				Price
<p>The two-sided spindle tips are spare parts for mechanical pressure spindles of series 6. The two-sided spindle tips ensure optimum adaptation of the spindle to the shaft.</p> 	612140	34-1, 130-10, 32-1, 112-2, 202-1, 12-1, 120-10, 120-ST, 33, 30-1, 30-1+, 30-1+S, 30-1+S-T, 30-1-S, 30-1-S-T, 203-1, 30-10, 30-10+, 30-10+S, 30-10+S-T, 110-1, 30-10-P3, 110-10, 30-10-S, 30-10-S-T, 30-10-SP, 201-1, 120-1, 68-1, 44-1, 45-1, 44-2, 45-2, 130-2, 113-20, 112-20, 20-1, 20-ST, 20-1+, 20-ST+, 20+ST+S, 205-01, 20-1+S, 20-ST+S, 20-1+S-T, 20-1-2, 20-1-25, 20-1-4, 20-ST-S, 20-10, 20-10+, 14-2, 20-10+S, 206-01, 34-0	0,01 kg	1	40,00 EUR



612140	KU-STA	Item number				Price
		616180	32-2, 12-2, 18-1, 15-A, 17-A, 110-2, 110-20, 482-4, 483-4, 69-B, 17-2, 17-B, 204-1, 44-3, 45-3, 113-3, 112-3	0,03 kg	1	40,00 EUR
		620260	30-2-S, 30-20, 30-20+, 30-20-B, 30-20+B, 30-20+S, 30-20-3, 30-20-3-B, 30-20-P2, 30-20-S, 30-20-SP, 210-1, 31-1, 31-2, 201-2, 200-U, 200-UM, 205-02, 205-02-B, 20-2+S, 20+ST+S, 202-2, 20-2-3, 20-2-3-B, 20-2-S, 20-ST-S, 20-20, 20-20-B, 20-ST, 20-20+, 20-20+B, 20-ST+, 20-20+S, 20-ST+S, 20-20-3, 20-20-3-B, 20-20-P2, 20-20-S, 206-02, 206-02-B, 20-20-SP, 20-2, 20-2-B, 207-02, 207-02-B, 20-2+, 20-2+B, 203-2	0,045 kg	1	40,00 EUR







612140	KU-STA	Item number				Price
		633370	20-4-4-B, 20-4-5, 20-4-5-B, 226-4/11, 20-40, 20-40-B, 20-40-4, 20-40-4-B, 20-40-5, 20-40-5-B, 47-1-A, 47-1-B, 12-6, 12-7, 44-8, 45-8, 46-2-A, 46-2-B, 47-2-A, 47-2-B, 20-4-AV, 20-40-AV, 45-7, 44-7, 18-5, 18-5-B, 20-5-AV, 20-5, 20-5-H, 20-4-H, 30-40, 30-5, 11-1-A, 11-2-A, 11-2-A3, 11-1-A4, 11-1-A3, 11-1-A5, 11-2-A4, 11-2-A5, 11-1-AV, 11-2-AV, 10-M, 30-30, 30-4, 11-0-A3, 11-0-AV, 11-0-A5, 30-30+, 30-30+B, 11-0-A4, 15-D, 46-1-A, 46-1-B, 20-4, 20-4-B, 20-4-3, 20-4-3-B, 20-4-4	0,125 kg	1	24,00 EUR

638317	KU-STA	Item number				Price
<p>The thrust piece is a spare part for hydraulic spindles, which is used for quick positioning and fixing of workpieces.</p> 		638317	8-HP-626, 8-HP-633, K-8- HP-621, 8- HP-637, K-8- HP-623, 8- HP-621, 8- HP-800, K-8- HP-626, K-8- HP-633, K-8- HP-637, K-8- HP-800, 8- HP-623	0,08 kg	1	80,00 EUR

Spare parts > Spare parts > Powernut

670000	Ku-STA	Item number		SW 		Price
<p>The Power Nut is a true miracle of strength! It can be used to apply forces that can otherwise only be achieved with hydraulics. KUKKO has developed the Power Groove for effortless clamping of tools and workpieces as well as driving without major friction loss.</p> 		670817 NEW	M8	17	1	54,20 EUR
		671017 NEW	M10	17	1	54,20 EUR
		671217 NEW	M12	17	1	54,20 EUR
		671224 NEW	M12	24	1	54,20 EUR
		671519 NEW	M15	19	1	54,20 EUR
		671624 NEW	M16	24	1	54,20 EUR
		671827 NEW	M18	24	1	54,20 EUR
		672032 NEW	M20	32	1	81,40 EUR
		672132 NEW	G 1/2 Zoll	32	1	81,40 EUR
		672432 NEW	M24	32	1	81,40 EUR
		672646 NEW	G 3/4 Zoll	46	1	151,20 EUR
		673046 NEW	M30	46	1	151,20 EUR
		673655 NEW	M36	55	1	151,20 EUR

Grip / Hold > Grip / Hold > Spring compressor

65	Ku-STA	Item number				Price
<p>The "Universal" spring compressors of the 65 series are used to remove and tension coil springs in the automotive industry. Spring compressors are simple but important tools that enable the safe removal and installation of springs and shock absorbers on most vehicles.</p> 		65-0	110 mm - 180 mm	100 mm - 200 mm	1	285,60 EUR
		65-1	110 mm - 180 mm	100 mm - 300 mm	1	314,40 EUR
		65-2	110 mm - 180 mm	100 mm - 400 mm	1	351,20 EUR

66

Ku-STA

Item number



Price

The "MacPherson" spring compressors of the 66 series are used for the removal and tensioning of coil springs. Spring compressors are simple but important tools that enable the safe removal and installation of springs and shock absorbers. The "MacPherson" design can cope with even the heaviest springs.



66-1

110 mm -
180 mm

100 mm -
250 mm

1

342,80 EUR

66-2

110 mm -
180 mm

100 mm -
400 mm

1

361,20 EUR

66-3





110 mm -
180 mm











100 mm -
400 mm

1

429,00 EUR

Pulling > Removing > Ball bearing puller set with grippers in hemispherical shape

69	Ku-STA	Item number	 max.			Price
<p>The series 69 ball bearing puller sets are used to remove ball bearings of all types that are located in a housing and/or on a shaft. In addition to minimising the amount of work involved, the application also ensures the safety and integrity of the housing or shaft.</p> 	69-A	20 mm - 110 mm	6004, 6005, 6006, 6007, 6008, 6009, 6010, 6011, 6012, 6013, 6201, 6202, 6203, 6204, 6205, 6206, 6300, 6301, 6302, 6303, 6304, 6305	1	436,00 EUR	
	69-B	40 mm - 140 mm	6011, 6012, 6013, 6014, 6015, 6016, 6017, 6018, 6019, 6020, 6206, 6207, 6208, 6209, 6210, 6211,6212 , 6305, 6306, 6307, 6308, 6309, 6403, 6404, 6405, 6406, 6407	1	592,20 EUR	

69	Ku-STA	Item number	 max.			Price
		69-C	60 mm - 240 mm	6021, 6022, 6024, 6026, 6028, 6030, 6032, 6213, 6214, 6215, 6216, 6217, 6218, 6219, 6220, 6221, 6222, 6224, 6226, 6228, 6230, 6310, 6311, 6312, 6313, 6314, 6315, 6316, 6317, 6318, 6319, 6320, 6321, 6406, 6407, 6408, 6409, 6410, 6411, 6412	1	1.266,40 EUR
69-T	Ku-STA	Item number				Price
<p>The crossbars are spare parts for ball bearing extraction sets "Universal" of the 69 series.</p> 		69-A-T	69-A, 27-A	0,225 kg	1	120,00 EUR
		69-B-T	69-B	0,325 kg	1	160,00 EUR
		69-C-T	69-C	1,52 kg	1	160,00 EUR
69-P	Ku-STA	Item number				Price
<p>The tension bolts are spare parts for ball bearing extraction sets "Universal" of series 69. The tension bolts ensure an even pull of the inner and outer bearing ring.</p> 		069061	69-A	0,04 kg	1	60,00 EUR
		069162	69-B	0,195 kg	1	60,00 EUR

















Spare parts > Spare parts > Bearing adapter

69-A1/C9	KU-STA	Item number				Price
<p>The bearing adapters are spare parts for the ball bearing extraction sets "Universal" of the 69 series. The bearing adapters, available in pairs, are available in different sizes.</p>	69-A1	69-A	0,03 kg	1	120,00 EUR	
	69-A2	69-A	0,03 kg	1	120,00 EUR	
	69-A3	69-A	0,03 kg	1	120,00 EUR	
	69-B3	69-B	0,035 kg	1	40,00 EUR	
	69-B4	69-B	0,04 kg	1	120,00 EUR	
	69-B5	69-B	0,045 kg	1	120,00 EUR	
	69-B6	69-B	0,045 kg	1	120,00 EUR	
	69-C10	69-C	0,37 kg	1	160,00 EUR	
	69-C11	69-C	0,524 kg	1	160,00 EUR	
	69-C12	69-C	0,618 kg	1	160,00 EUR	
	69-C7	69-C	0,16 kg	1	160,00 EUR	
	69-C8	69-C	0,22 kg	1	160,00 EUR	
	69-C9	69-C	0,265 kg	1	160,00 EUR	



Grip / Hold > Pliers > Grip pliers

689	SCANGR	Item number				Price
<p>The Langbeck grip tongs of the 689 series are used for clamping and gripping in narrowly tapered places. The grip tongs are not only handy and can be operated with one hand, the toggle lever mechanism also allows very high forces to be applied with reduced accessibility.</p>	689-150	40 mm	150 mm	1	42,70 EUR	
	689-230	55 mm	230 mm	1	57,60 EUR	
690+	TU_RES	Item number				Price
<p>The universal gripping pliers of the 690+ series are used to securely hold round, profile and flat material. The gripping pliers are not only handy and can be operated with one hand, the toggle lever mechanism also allows very high forces to be applied.</p>	690+004	30 mm	220 mm	1	44,20 EUR	
691+	TU_RES	Item number				Price
<p>The universal opti-grip pliers of the 691+ series are used to securely hold round, profile and flat material. The gripping pliers are not only handy and can be operated with one hand, the toggle lever mechanism also allows very high forces to be applied.</p>	691+005	30 mm	220 mm	1	58,00 EUR	
690	SCANGR	Item number				Price
<p>The universal gripping pliers of the 690 series are used to securely hold round, profile and flat material. The gripping pliers are not only handy and can be operated with one hand, the toggle lever mechanism also allows very high forces to be applied.</p>	690-180	35 mm	180 mm	1	59,00 EUR	
	690-250	50 mm	250 mm	1	63,00 EUR	
	690-300	65 mm	300 mm	1	52,60 EUR	











691	SCANGR	Item number				Price
<p>The Prisma grip tongs of the 691 series are used to securely hold round, profile and flat material. The gripping pliers are not only handy and can be operated with one hand, the toggle lever mechanism also allows very high forces to be applied.</p> 		691-180	30 mm	180 mm	1	39,60 EUR
		691-250	35 mm	250 mm	1	41,60 EUR
693	SCANGR	Item number				Price
<p>The parallel-plus grip pliers of the 693 series are used to securely hold round, profile and flat material. The gripping pliers are not only handy and can be operated with one hand, the toggle lever mechanism also allows very high forces to be applied.</p> 		693-250	45 mm	250 mm	1	41,60 EUR
694	SCANGR	Item number				Price
<p>The wide jaw grip tongs are used for clamping edges and surfaces. The gripping pliers can not only be operated with one hand, the toggle lever mechanism also allows very high forces to be applied and, thanks to their jaw shape, they can be used for clamping and flanging thin, soft sheet metal.</p> 		694-275	45 mm	180 mm	1	40,40 EUR
696	SCANGR	Item number				Price
<p>The pipe welder grip tongs of the 696 series are used for centric clamping when welding round or pipe material on impact. The grip tongs are not only handy and can be operated with one hand, the toggle lever mechanism also allows very high forces to be applied.</p> 		696-280	90 mm	280 mm	1	45,60 EUR

Care and safety > Care and safety > Fall protection





660	Ku-STA	Item number	∅			Price
<p>Series 660 drop guards are used to secure the puller and prevent falls when pulling outdoors. The snap hook is able to attach the puller to a designated attachment point and the attachment ring prevents falling.</p> 		660-614 NEW	19 mm	614135, 614160, 614200, 614242, 614250	1	51,60 EUR
		660-616 NEW	21 mm	616202, 616220, 616270, 616325	1	56,80 EUR
		660-618 NEW	23 mm	618068, 618105, 618175, 618210	1	62,00 EUR
		660-620 NEW	25 mm	620172, 620230, 620250	1	62,00 EUR

Care and safety > Care and safety > Special grease

KSF-69	Ku-STA	Item number				Price
<p>The green KUKKO special grease for pressure spindles protects and maintains applied spindles and is used especially for high extraction forces in crafts, industry and workshops. Due to the reduced friction, the efficiency during extraction is increased and wear is reduced to a minimum.</p> 	Ku-STA	699904	0,005 kg	4	1	23,20 EUR
		699915	0,02 kg	15	1	23,20 EUR
KFS-69-C	Ku-STA	Item number				Price
<p>The green KUKKO special grease for pressure spindles protects and maintains applied spindles and is used especially for high extraction forces in crafts, industry and workshops. Due to the reduced friction, the efficiency during extraction is increased and wear is reduced to a minimum.</p> 	Ku-STA	699975	0,1 kg	75	1	36,20 EUR
699990	Ku-STA	Item number				Price
<p>The organic multi-oil "6 in 1" by KUKKO protects and maintains the spindle at high extraction forces in craft, industry and workshop.</p> 	Ku-STA	699990	0,12 kg	100	1	36,20 EUR
ERS-OIL	KU-STA	Item number				Price
<p>The hydraulic oil in dosing bottle is used together with the grease hydraulic tools from KUKKO in trade, industry and workshop. The spray can enables easy dosing of the hydraulic oil.</p> 	KU-STA	ERS-OIL	800, 801, 9-1, 9-2	0,07 kg	1	40,00 EUR



K-70	Ku-STA	Item number				Price
<p>The ball bearing extraction set "PULLPO" is used for the completely non-destructive extraction of deep groove ball bearings without removing the shaft. Even without the possibility of support, the PULLPO can safely pull off otherwise unrippable bearings and thus ensure the reuse of the parts concerned.</p>		K-70-A	70-01-T, 610120, 70-011-S, 70-012-S, 700117, , 70-01-R	1,91 kg	1	920,80 EUR
		K-70-B	70-02-T, 70-02-R, 700217, 614242, 70-021-S, 70-022-S,	4,365 kg	1	1.324,20 EUR
		K-70-C	70-01-T, 70-02-T, 610120, 614242, 70-011-S, 70-012-S, 70-021-S, 70-022-S, 700117, 700217, 70-01-R, 70-02-R,	7,125 kg	1	2.097,60 EUR









Pulling > Removing > Deep groove ball bearing puller with hooked claws











70-0	Ku-STA	Item number				Price
<p>The "PULLPO" series 70 ball bearing puller is used for the completely non-destructive removal of deep groove ball bearings without removing the shaft. Even without the possibility of support, the PULLPO can safely remove bearings that would otherwise be impossible to grip, thus ensuring that the parts can be reused.</p>		70-01	70-011, 70-012	0,4 kg	1	184,80 EUR
		70-02	70-021, 70-022	1,3 kg	1	230,20 EUR

K-70	Ku-STA	Item number				Price
<p>The ball bearing extraction set "PULLPO" is used for the completely non-destructive extraction of deep groove ball bearings without removing the shaft. Even without the possibility of support, the PULLPO can safely pull off otherwise ungrippable bearings and thus ensure the reuse of the parts concerned.</p> 		K-70-A	70-01-T, 610120, 70-011-S, 70-012-S, 700117, , 70-01-R	1,91 kg	1	920,80 EUR
		K-70-B	70-02-T, 70-02-R, 700217, 614242, 70-021-S, 70-022-S,	4,365 kg	1	1.324,20 EUR
		K-70-C	70-01-T, 70-02-T, 610120, 614242, 70-011-S, 70-012-S, 70-021-S, 70-022-S, 700117, 700217, 70-01-R, 70-02-R,	7,125 kg	1	2.097,60 EUR

Spare parts > Spare parts > Ring set

70-01-R	KU-STA	Item number				Price
<p>The ring sets are spare parts for the ball bearing extractors "PULLPO" of the series 70. The hooks or arms of the PULLPO are inserted into the outer ring of the bearing with the help of the rings.</p> 		70-01-R	70-1	0 kg	1	117,60 EUR
		70-02-R	70-2	0,535 kg	1	160,00 EUR
70-T	KU-STA	Item number				Price
<p>The traverses are spare parts for ball bearing extractors "PULLPO" of the series 70.</p> 		70-01-T	K-70-A, K-70-A-C	0 kg	1	160,00 EUR
		70-02-T	K-70-B, K-70-B-C	0 kg	1	193,90 EUR
700117	KU-STA	Item number				Price
<p>Pressure pieces are spare parts for various KUKKO tools, which are used for quick positioning and fixing of workpieces.</p> 		700117	70-01	0 kg	1	80,00 EUR
		700217	70-02	0 kg	1	120,00 EUR

70-S	KU-STA	Item number				Price
<p>The 70-S series puller hook sets are suitable for 70-0 series ball bearing extractors and are used for the non-destructive extraction of deep groove ball bearings without removing the shaft. In addition to the hooks, the sets also include support rings as spare parts.</p> 		70-011	70-01	0,1 kg	1	520,00 EUR
		70-012	70-01	0,105 kg	1	520,00 EUR
		70-021	70-02	0,64 kg	1	760,00 EUR
		70-022	70-02	0,675 kg	1	760,00 EUR
70-0-S	Ku-STA	Item number				Price
<p>The 70-0-S series puller hook sets are suitable for 70-0 series ball bearing extractors and are used for the non-destructive extraction of deep groove ball bearings without removing the shaft. In addition to the hooks, the sets also include support rings as spare parts.</p> 		70-011-S	6000, 6001, 6002, 6003, 6004, 6200, 6201, 6202, 6301	70 mm	1	351,40 EUR
		70-012-S	6005, 6006, 6203, 6204, 6205, 6300, 6302, 6303, 6304	70 mm	1	391,80 EUR
		70-021-S	6007, 6008, 6009, 6010, 6011, 6012, 6013, 6206, 6210, 6211, 6306, 6307	156 mm	1	690,80 EUR
		70-022-S	6014, 6015, 6016, 6017, 6018, 6019, 6020, 6207, 6208, 6209, 6212, 6305, 6308, 6309, 6310, 6311,6403 , 6404, 6405, 6406, 6407, 6408	156 mm	1	719,80 EUR

70-K	Ku-STA	Item number				Price
<p>The ball bearing extractor sets are used for the non-destructive extraction of deep groove ball bearings without removing the shaft. With these extractors, bearings that are simultaneously in a housing and on a shaft are easily and quickly extracted and can be reused.</p> 	70-K NEW	70-1, 70-711, 70-712, 70-713, 70-2, 70-721, 70-722	6,165 kg	1	1.222,80 EUR	
	70-A NEW	70-1, 70-711, 70-712, 70-713, 70-2, 70-721, 70-722, 70-3, 70-731, 70-732	10,025 kg	1	1.902,00 EUR	
	70-B NEW	70-4, 70-4730, 70-4731, 70-4733, 70-4734	19,44 kg	1	3.554,40 EUR	
70	Ku-STA	Item number				Price
<p>The series 70 ball bearing pullers are used for the non-destructive removal of deep groove ball bearings without removing the shaft. These pullers are used to quickly and easily remove and reuse bearings that are located in a housing and on a shaft at the same time.</p> 	70-1	70-711, 70-712, 70-713	0,38 kg	1	87,60 EUR	
	70-2	70-721, 70-722	0,67 kg	1	146,20 EUR	
	70-3	70-731, 70-732	1,38 kg	1	253,80 EUR	
	70-4	70-4730, 70-4731, 70-4733, 70-4734	2,315 kg	1	475,00 EUR	
KS-70-A-K	Ku-STA	Item number				Price
<p>The 70 series ball bearing extractor sets are used for the non-destructive extraction of deep groove ball bearings without removing the shaft. With these extractors, bearings that are simultaneously in a housing and on a shaft are easily and quickly extracted and can be reused.</p> 	KS-70-A-K	70-A-K-36, 70-1, 70-2, 699915, 70-711-K, 70-712-K, 70-713-K, 70-714-K, 70-715-K, 70-721-K, 70-722-K	9,875 kg	1	2.145,20 EUR	

70-4S

Ku-STA



Price

The 70-S series puller hook sets are suitable for 70 series ball bearing extractors and are used for the non-destructive extraction of deep groove ball bearings without removing the shaft. In addition to the hooks, the sets also include support rings as spare parts.

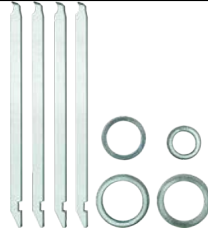





Item number					
70-711	6000, 6001, 6002, 6003, 6200	150 mm	1	169,20 EUR	
70-712	6004, 6005, 6006, 6201, 6202, 6203, 6300	150 mm	1	190,80 EUR	
70-713	6204, 6205, 6301, 6302, 6303	170 mm	1	190,80 EUR	
70-721	6007, 6008, 6009, 6010, 6011, 6012, 6013	180 mm	1	190,80 EUR	
70-722	6011, 6012, 6206, 6207, 6304, 6005, 6306	180 mm	1	190,80 EUR	
70-731	6208, 6209, 6210, 6307, 6403, 6407	217 mm	1	296,60 EUR	
70-732	6211, 6212, 6308, 6309, 6310, 6311, 6404, 6405, 6406, 6407, 6408	217 mm	1	296,60 EUR	
70-4730	6014, 6015, 6016, 6017	217 mm	1	665,20 EUR	
70-4731	6018, 6019, 6020, 6213	217 mm	1	775,80 EUR	













70-4S	Ku-STA	Item number				Price
		70-4733	6216, 6217, 6218, 6219, 6220, 6221, 6222, 6312, 6313, 6314, 6315, 6316, 6317, 6410, 6411, 6412	290 mm	1	1.711,20 EUR
		70-4734	6021, 6409	290 mm	1	341,80 EUR
70-A-K-S	KU-STA	Item number				Price
<p>The 70-A-K-S series puller hook sets are suitable for 70 series ball bearing extractors and are used for the non-destructive extraction of deep groove ball bearings without removing the shaft. In addition to the hooks, the sets also include support rings as spare parts.</p>		70-711-K	KS-70-A-K	0,205 kg	1	120,00 EUR
		70-712-K	KS-70-A-K	0,22 kg	1	200,00 EUR
		70-713-K	KS-70-A-K	0,295 kg	1	200,00 EUR
		70-714-K	KS-70-A-K	0,45 kg	1	120,00 EUR
		70-715-K	KS-70-A-K	0,56 kg	1	120,00 EUR
		70-721-K	KS-70-A-K	1,4 kg	1	320,00 EUR
		70-722-K	KS-70-A-K	2,05 kg	1	320,00 EUR
KS-70-A-K	Ku-STA	Item number				Price
<p>The 70 series ball bearing extractor sets are used for the non-destructive extraction of deep groove ball bearings without removing the shaft. With these extractors, bearings that are simultaneously in a housing and on a shaft are easily and quickly extracted and can be reused.</p>		KS-70-A-K	70-A-K-36, 70-1, 70-2, 699915, 70-711-K, 70-712-K, 70-713-K, 70-714-K, 70-715-K, 70-721-K, 70-722-K	9,875 kg	1	2.145,20 EUR
70-A-K-36	KU-STA	Item number				Price
<p>The retaining ring set consists of three retaining rings and is a spare part for ball bearing extraction sets of the KS-70-A-K series.</p>		70-A-K-36	KS-70-A-K	0,025 kg	1	40,00 EUR

Pressing / Inserting > Pressing / Inserting > Bearing installation tools

K-71-L	Ku-STA	Item number				Price
<p>The ball bearing installation kits of the K-71 series are used for the fast, precise and safe installation of bearings and seals. The tool set ensures damage-free installation of bearings without damaging axles, bearing housings or sealing rings, even on mobile applications.</p> 		K-71-L-A	19, 32	26 - 55	1	960,68 EUR
		K-71-L-B	32, 50	52 - 110	1	805,42 EUR
		K-71-L-C	32, 50	26 - 110	1	1.015,00 EUR

Spare parts > Spare parts > Impact sleeve

71-K-SH	KU-STA	Item number				Price
<p>The impact sleeves are spare parts for the ball bearing installation kits of the K-71 series. Together with the impact rings they are required for bearing installation.</p> 		71-K-SH-A	71	0,255 kg	1	80,00 EUR
		71-K-SH-C	71	0,54 kg	1	120,00 EUR
71-L-F	Ku-STA	Item number				Price
<p>The 71-L-F series steel bearing installation tool set is used for the quick, precise and safe installation of bearings and seals in trade, industry and workshops. The set contains 33 impact rings, 3 impact tubes made of extra-strong steel and a soft-face mallet. The tool set guarantees damage-free installation of bearings, axles, bearing housings or sealing rings and is used in the food industry, for example.</p> 		71-L-F NEW	19, 32, 50 mm	26 - 110 mm	1	1.394,40 EUR
71-L	Ku-STA	Item number				Price
<p>The bearing installation tool set made of steel as a lightweight external assembly model is used for the fast, precise and safe installation of bearings and seals. The tool set enables damage-free installation of bearings without damaging axles, bearing housings or sealing rings.</p> 		71-L	19, 32, 50 mm	26 - 110 mm	1	1.394,40 EUR
71-L-SH	KU-STA	Item number				Price
<p>The impact sleeves are spare parts for the bearing installation tool sets of the 71-L series. Together with the impact rings they are needed for bearing installation.</p> 		71-L-SH-A	71-L	0,15 kg	1	80,00 EUR
		71-L-SH-B	71-L	0,33 kg	1	80,00 EUR
		71-L-SH-C	71-L	0,65 kg	1	80,00 EUR

71-L-H	KU-STA	Item number				Price
<p>The impact sleeves are spare parts for the bearing installation tool sets of the 71-L series. Together with the impact rings they are needed for bearing installation.</p> 		71-L-H-A	71-L	0 kg	1	24,00 EUR
		71-L-H-B	71-L	0 kg	1	40,00 EUR
71-L-ABC	KU-STA	Item number				Price
<p>The ABC holders are spare parts for the bearing installation tool sets of the 71-L series.</p> 		71-L-ABC	71-L	0 kg	1	80,00 EUR
71-L-SK	KU-STA	Item number				Price
<p>The impact head is a spare part for the bearing installation tool sets of the 71-L series. It is used for driving in and mounting workpieces and pipes.</p> 		71-L-SK	71-L	0 kg	1	80,00 EUR

Spare parts > Spare parts > Brass knuckles

71-L-SR	KU-STA	Item number				Price
<p>The plastic impact rings are spare parts for the bearing installation tool set (light outdoor assembly model) of the 71-L series. The impact rings, made of extremely impact-resistant plastic, are required for the installation of bearings and seals.</p>		71-L-SR-9	71-L	0,025 kg	1	40,00 EUR
		71-L-SR-8	71-L	0,015 kg	1	40,00 EUR
		71-L-SR-7	71-L	0,01 kg	1	40,00 EUR
		71-L-SR-6	71-L	0,02 kg	1	40,00 EUR
		71-L-SR-5	71-L	0,01 kg	1	40,00 EUR
		71-L-SR-4	71-L	0,01 kg	1	40,00 EUR
		71-L-SR-33	71-L	0,155 kg	1	60,00 EUR
		71-L-SR-32	71-L	0,09 kg	1	60,00 EUR
		71-L-SR-31	71-L	0,06 kg	1	60,00 EUR
		71-L-SR-30	71-L	0,125 kg	1	60,00 EUR
		71-L-SR-3	71-L	0,015 kg	1	40,00 EUR
		71-L-SR-29	71-L	0,08 kg	1	60,00 EUR
		71-L-SR-28	71-L	0,05 kg	1	60,00 EUR
		71-L-SR-27	71-L	0,1 kg	1	60,00 EUR
		71-L-SR-26	71-L	0,065 kg	1	60,00 EUR
		71-L-SR-25	71-L	0,035 kg	1	60,00 EUR
		71-L-SR-24	71-L	0,07 kg	1	60,00 EUR
		71-L-SR-23	71-L	0,045 kg	1	60,00 EUR
		71-L-SR-22	71-L	0,035 kg	1	60,00 EUR
		71-L-SR-21	71-L	0,07 kg	1	60,00 EUR
		71-L-SR-20	71-L	0,045 kg	1	60,00 EUR
		71-L-SR-2	71-L	0,01 kg	1	40,00 EUR
		71-L-SR-19	71-L	0,03 kg	1	60,00 EUR
		71-L-SR-18	71-L	0,05 kg	1	60,00 EUR
		71-L-SR-17	71-L	0,025 kg	1	40,00 EUR
		71-L-SR-16	71-L	0,02 kg	1	40,00 EUR
		71-L-SR-15	71-L	0,025 kg	1	40,00 EUR
		71-L-SR-14	71-L	0,02 kg	1	40,00 EUR
		71-L-SR-13	71-L	0,2 kg	1	40,00 EUR
		71-L-SR-12	71-L	0,03 kg	1	40,00 EUR
71-L-SR-11	71-L	0,02 kg	1	40,00 EUR		
71-L-SR-10	71-L	0,015 kg	1	40,00 EUR		
71-L-SR-1	71-L	0,01 kg	1	40,00 EUR		
71-M	KU-STA	Item number				Price
<p>The steering head bearing installation kit of series 71-M is used to install steering head bearings on motorbikes. Due to the special shape of the impact rings, the force is transmitted exclusively to the inner ring when pressing in the taper roller bearing and destruction of the bearing cage is excluded.</p>		71-M	32	25-35	1,935 kg	365,00 EUR
71-M-SH	KU-STA	Item number				Price
<p>The impact sleeves are spare parts for the steering head bearing installation kits of the 71-M series. Together with the impact rings they are needed for the bearing installation.</p>		71-M-SH	71-M	0,515 kg	1	80,00 EUR

71-M-SR	KU-STA	Item number				Price
<p>The impact rings are spare parts for the steering head bearing installation kit of the 71-M series. The impact rings with a special shape are required for the installation of steering head bearings on motorbikes.</p>		71-M-SR-25	71-M	0,515 kg	1	80,00 EUR
		71-M-SR-28	71-M	0,515 kg	1	80,00 EUR
		71-M-SR-30	71-M	0,515 kg	1	80,00 EUR
		71-M-SR-35	71-M	0,515 kg	1	80,00 EUR
71	Ku-STA	Item number				Price
<p>The heavy-duty steel bearing installation tool set of series 71 is used for the installation of bearings by means of a hydraulic press or hammer. The tool set enables damage-free installation of bearings without damaging axles, bearing housings or sealing rings.</p>		71	15; 20; 30; 40; 55	26 - 110	1	2.520,00 EUR
71-SH	KU-STA	Item number				Price
<p>The impact sleeves are spare parts for the bearing installation tool sets of series 71. Together with the impact rings they are required for bearing installation.</p>		71-SH-A	71	0,625 kg	1	80,00 EUR
		71-SH-B	71	0,8 kg	1	120,00 EUR
		71-SH-C	71	1,185 kg	1	120,00 EUR
		71-SH-D	71	1,605 kg	1	160,00 EUR
		71-SH-E	71	2,3 kg	1	200,00 EUR

71-SR	KU-STA	Item number				Price
<p>The impact rings are spare parts for the bearing installation tool set (heavy-duty version) of series 71. The impact rings made of extra strong steel are required for the installation of bearings by means of a hydraulic press or hammer.</p>		71-SR-1	71	0,0035 kg	1	40,00 EUR
		71-SR-2	71	0,05 kg	1	40,00 EUR
		71-SR-3	71	0,001 kg	1	60,00 EUR
		71-SR-4	71	0,04 kg	1	40,00 EUR
		71-SR-5	71	0,05 kg	1	40,00 EUR
		71-SR-6	71	0,07 kg	1	60,00 EUR
		71-SR-7	71	0,05 kg	1	60,00 EUR
		71-SR-8	71	0,06 kg	1	60,00 EUR
		71-SR-9	71	0,091 kg	1	60,00 EUR
		71-SR-10	71	0,055 kg	1	60,00 EUR
		71-SR-11	71	0,075 kg	1	60,00 EUR
		71-SR-12	71	0,115 kg	1	60,00 EUR
		71-SR-13	71	0,0095 kg	1	60,00 EUR
		71-SR-14	71	0,12 kg	1	60,00 EUR
		71-SR-15	71	0,15 kg	1	60,00 EUR
		71-SR-16	71	0,105 kg	1	60,00 EUR
		71-SR-17	71	0,155 kg	1	60,00 EUR
		71-SR-18	71	0,27 kg	1	80,00 EUR
		71-SR-19	71	0,145 kg	1	80,00 EUR
		71-SR-20	71	0,195 kg	1	80,00 EUR
		71-SR-21	71	0,275 kg	1	120,00 EUR
		71-SR-22	71	0,195 kg	1	80,00 EUR
		71-SR-23	71	0,335 kg	1	120,00 EUR
		71-SR-24	71	0,455 kg	1	120,00 EUR
		71-SR-25	71	0,22 kg	1	120,00 EUR
		71-SR-26	71	0,335 kg	1	160,00 EUR
		71-SR-27	71	0,45 kg	1	160,00 EUR
		71-SR-28	71	0,25 kg	1	120,00 EUR
		71-SR-29	71	0,514 kg	1	160,00 EUR
		71-SR-30	71	0,7 kg	1	160,00 EUR
		71-SR-31	71	0,3 kg	1	160,00 EUR
		71-SR-32	71	0,48 kg	1	160,00 EUR
		71-SR-33	71	0,89 kg	1	200,00 EUR

Pulling > Removing > Pin punch

720-S	KU-STA	Item number				Price
<p>The 720 series pin punch set is used for driving out pins and similar parts in trade, industry and workshops. The set contains pin punches in six different diameters, allowing the optimum tool to be selected depending on the application.</p>		720-028	150 mm	2; 3; 4; 5; 6; 8 mm	1	77,80 EUR

720	Ku-STA	Item number	L			Price
<p>The 720 series cotter pin punch is used to drive out cotter pins and similar parts. The pin punch is available in various tip diameters and shank lengths, allowing the optimum tool to be selected depending on the application.</p> 		720-002	150 mm	2 mm	1	13,00 EUR
		720-003	150 mm	3 mm	1	13,00 EUR
		720-004	150 mm	4 mm	1	13,00 EUR
		720-005	150 mm	5 mm	1	13,00 EUR
		720-006	150 mm	6 mm	1	13,00 EUR
		720-008	150 mm	8 mm	1	13,00 EUR

Grip / Hold > Grip / Hold > Chisel holder





721	Ku-STA	Item number	L	für for		Price
<p>The 721 series chisel holders are used for protection during chisel work and similar activities in crafts, industry and workshops. The shape and design of the green holder protects the user and prevents hand injuries in everyday work.</p> 		721-1	120 mm	20x12 - 26x13; 26x7; 16 - 20	1	10,50 EUR

728K-729	Ku-STA	Item number				Price
<p>The circlip pliers set is used for mounting and dismounting circlips on shafts and in bores. The simple but strong forged shape of the various circlip pliers allows safe and quick work in every application.</p> 		728K-729	728K-A1, 728K-A2, 728K-A11, 729K-J1, 729K-J2, 729K-J11, 729K-J21	1,17 kg	1	309,60 EUR

Pulling > Removing > Circlip pliers

728-A	Ku-STA	Item number	L			Price
<p>The circlip pliers for outer rings are used for fitting and removing circlips on shafts. The simple but sturdy forged shape enables safe and fast work in any application. The circlip pliers are available in various sizes.</p> 		728K-A0	135 mm	3-10	1	33,60 EUR
		728K-A1	135 mm	10-25	1	28,20 EUR
		728K-A2	180 mm	19 - 60	1	32,00 EUR
		728K-A3	225 mm	40 - 100	1	47,40 EUR

728K-729	Ku-STA	Item number				Price
<p>The circlip pliers set is used for mounting and dismounting circlips on shafts and in bores. The simple but strong forged shape of the various circlip pliers allows safe and quick work in every application.</p> 		728K-729	728K-A1, 728K-A2, 728K-A11, 729K-J1, 729K-J2, 729K-J11, 729K-J21	1,17 kg	1	309,60 EUR

728-A-1	Ku-STA	Item number	L			Price
<p>The circlip pliers for outer rings are used for fitting and removing circlips on shafts. The simple but sturdy forged shape enables safe and fast work in any application. They are available in different sizes depending on the diameter.</p> 		728K-A01	135 mm	3-10	1	36,00 EUR
		728K-A11	135 mm	10-25	1	30,00 EUR
		728K-A21	180 mm	19 - 60	1	38,00 EUR
		728K-A31	225 mm	40 - 100	1	51,00 EUR
728K-729	Ku-STA	Item number				Price
<p>The circlip pliers set is used for mounting and dismantling circlips on shafts and in bores. The simple but strong forged shape of the various circlip pliers allows safe and quick work in every application.</p> 		728K-729	728K-A1, 728K-A2, 728K-A11, 729K-J1, 729K-J2, 729K-J11, 729K-J21	1,17 kg	1	309,60 EUR
729-J	Ku-STA	Item number	L			Price
<p>The circlip pliers for inner rings are used for fitting and removing circlips in drilled holes in trade, industry and workshops. The simple but sturdy forged shape enables safe and fast work in any application.</p> 		729K-J0	135 mm	8-13	1	33,60 EUR
		729K-J1	135 mm	10-25	1	28,20 EUR
		729K-J2	180 mm	19 - 60	1	32,00 EUR
		729K-J3	225 mm	40 - 100	1	43,60 EUR
728K-729	Ku-STA	Item number				Price
<p>The circlip pliers set is used for mounting and dismantling circlips on shafts and in bores. The simple but strong forged shape of the various circlip pliers allows safe and quick work in every application.</p> 		728K-729	728K-A1, 728K-A2, 728K-A11, 729K-J1, 729K-J2, 729K-J11, 729K-J21	1,17 kg	1	309,60 EUR
729-J-1	Ku-STA	Item number	L			Price
<p>The circlip pliers for inner rings are used for fitting and removing circlips in drilled holes. The simple but sturdy forged shape enables safe and fast work in any application. The pliers are available in various sizes depending on the diameter.</p> 		729K-J01	135 mm	8-13	1	35,80 EUR
		729K-J11	135 mm	10-25	1	30,00 EUR
		729K-J21	180 mm	19 - 60	1	41,00 EUR
		729K-J31	225 mm	40 - 100	1	43,60 EUR





728K-729	Ku-STA	Item number				Price
<p>The circlip pliers set is used for mounting and dismounting circlips on shafts and in bores. The simple but strong forged shape of the various circlip pliers allows safe and quick work in every application.</p> 		728K-729	728K-A1, 728K-A2, 728K-A11, 729K-J1, 729K-J2, 729K-J11, 729K-J21	1,17 kg	1	309,60 EUR

Optional extensions > Accessories > Hydraulic spindle



8-0	Ku-STA	Item number	max.			Price
<p>The grease hydraulic spindle of the 8-0 series is the motor of the extractor and achieves a tractive force of 12 t. The hydraulic spindle is suitable for pulling off particularly tight bearings, gears and discs that cannot be loosened with pure muscle power.</p> 		8-0-621	10 t	12-4, 12-5, 18-2, 20-2, 20-20, 30-2, 30-20, 41-5, 42-5, 205-02, 206-02, 207-02	1	420,00 EUR
		8-0-626	12 t	12-6, 12-7, 18-3, 20-3, 20-30, 30-3, 205-1, 205-2, 205-3, 206-1, 206-2, 206-3, 207-1, 207-2, 207-3	1	520,00 EUR

Spare parts > Spare parts > Spindle insert & hydr.



8-1-H	KU-STA	Item number				Price
<p>The hydraulic parts for spindles are spare parts for long hydraulic spindles of series 8. The hydraulics allow easy and controlled removal of particularly tight parts.</p> 		8-1	8-1-B, 8-1-F	4,6 kg	1	760,00 EUR
		8-2	8-2-K, 8-2-M	5,695 kg	1	1.000,00 EUR

8	Ku-STA	Item number	max.			Price
<p>The grease hydraulic spindle of the 8 series is the motor of the extractor and achieves an average pulling force of 20 t. The hydraulic spindle is suitable for pulling off particularly tight bearings, gears and discs that cannot be loosened with pure muscle power.</p> 	Ku-STA	8-1-B	15 t	18-4, 20-4, 20-40	1	893,60 EUR
		8-1-F	15 t	46-1-A, 46-1-B, 46-2-A, 46-2-B, 47-1-A, 47-1-B, 47-2-A, 47-2-B	1	921,80 EUR
		8-2-K	20 t	11-1-A, 11-2-A	1	1.082,20 EUR
		8-2-M	20 t	18-5, 20-5	1	1.248,60 EUR
8-ERS	KU-STA	Item number				Price
<p>The wearing parts kits for long hydraulic spindles are used to replace worn parts of the long hydraulic spindles of series 8 and 8-0.</p> 	Ku-STA	8-1-ERS	8-1-B, 8-1-F	0,675 kg	1	320,00 EUR
		8-2-ERS	8-2-K, 8-2-M	0,915 kg	1	250,40 EUR
8-SE	KU-STA	Item number				Price
<p>The spindle inserts are spare parts for long hydraulic spindles of series 8. The inserts are needed for the combination of spindle and hydraulics.</p> 	Ku-STA	8-B	8-1-B	2,11 kg	1	320,00 EUR
		8-F	8-1-F	3,535 kg	1	520,00 EUR
		8-K	8-2-K	2,91 kg	1	320,00 EUR
		8-M	8-2-M	3,9 kg	1	431,00 EUR
K-8-HP	Ku-STA	Item number	max.			Price
<p>The hydraulic spindle with hand lever operation is suitable for extracting particularly tight bearings, gears and pulleys with an extraction force of up to 23 t. Thanks to the integrated grease hydraulics, no external pump is required. The lever arm of the pump can be swivelled through 360°.</p> 	Ku-STA	K-8-HP-621 NEW	4 t	G 1/2"	1	1.470,00 EUR
		K-8-HP-623 NEW	6 t	G 5/8"	1	1.587,60 EUR
		K-8-HP-626 NEW	12 t	G 3/4"	1	1.705,20 EUR
		K-8-HP-633 NEW	12 t	G 1"	1	1.846,00 EUR
		K-8-HP-637 NEW	15 t	G 1 1/8"	1	1.944,60 EUR
		K-8-HP-800 NEW	21 t	W 1 1/2"	1	2.058,00 EUR
8-HP	KU-STA	Item number	max.			Price
<p>The hydraulic spindle with hand lever operation is suitable for extracting particularly tight bearings, gears and discs with an extraction force of up to . Thanks to the integrated grease hydraulics, no external pump is required. The lever arm of the pump can be swivelled through 360°.</p> 	Ku-STA	8-HP-621 NEW	4 t	G 1/2"	1	1.176,00 EUR
		8-HP-623 NEW	6 t	G 5/8"	1	1.293,60 EUR
		8-HP-626 NEW	12 t	G 3/4"	1	1.411,20 EUR
		8-HP-633 NEW	12 t	G 1"	1	1.528,80 EUR
		8-HP-637 NEW	15 t	G 1 1/8"	1	1.646,40 EUR
		8-HP-800 NEW	21 t	W 1 1/2"	1	1.764,00 EUR

Spare parts > Spare parts > [Ersatzteile für 8-HP]

8-000	Ku-STA	Item number				Price
<p>The spindle extension is used to extend the spindle for the 8-HP series. It enables quick adaptation to a wide range of requirements. The extensions are available in different sizes depending on the application.</p> 		8-050	8-HP-633, 8-HP-637, 8-HP-800	0,125 kg	1	36,80 EUR
		8-100	8-HP-633, 8-HP-637, 8-HP-800	0,245 kg	1	57,20 EUR
		8-150	8-HP-633, 8-HP-637, 8-HP-800	0,37 kg	1	73,60 EUR
800	Ku-STA	Item number	max.			Price
<p>The grease-hydraulic spindle of the 800 series is the motor of the extractor and achieves an average tractive force of 20 tonnes. It can be used to dismantle particularly tightly fitted bearings, gears and discs with ease. The spindle impresses with its compact design and ease of use.</p> 		800	10 t	W 1.1/2"-16(5 5°;16Gang)	1	239,00 EUR
		801	15 t	W 1.1/2"-16(5 5°;16Gang)	1	455,20 EUR
		802	20 t	M40x1,5	1	598,00 EUR
		804	15 t	W 1.1/2"-16(5 5°;16Gang)	1	513,20 EUR

Optional extensions > Accessories > Spindle extension























800-0	Ku-STA	Item number	L			Price
<p>The spindle extension is used to extend the spindle for the 800 system series. It enables quick adaptation to a wide range of requirements. Depending on the application, the extensions are available in different sizes.</p> 		800-050	50 mm			18,40 EUR
		800-100	100 mm			20,60 EUR
		800-150	150 mm			32,80 EUR
800-626	Ku-STA	Item number				Price
<p>The mechanical impact shock spindle enables easy and controlled removal of particularly tight parts by impact action. In addition, the spindle guarantees particularly good sliding properties in the thread. The fine thread ensures ideal power transmission.</p> 		800-626	1.1/2"-16			306,00 EUR
800-ERS	Ku-STA	Item number				Price
<p>The wearing parts kits for short hydraulic spindles are used to replace worn parts of the short hydraulic spindles of the 800, 801 and 802 series.</p> 		800-ERS	800	0,2 kg	1	116,00 EUR
		801-ERS	801, 804	0,2 kg	1	189,00 EUR
		802-ERS	802	0,2 kg	1	189,00 EUR

Spare parts > Spare parts > Factory repair





800-REP	KU-STA	Item number				Price
<p>The KUKKO repair kits for short hydraulic spindles are used for the repair and maintenance of the short hydraulic spindles of the 800, 801 and 802 series in trade, industry and workshops.</p>		800-REP	800	0,2 kg	1	200,00 EUR
		801-REP	801	1,42 kg	1	320,00 EUR
		802-REP	802	1,9 kg	1	320,00 EUR
800017	KU-STA	Item number				Price
<p>The spindle thrust piece is a spare part for the short hydraulic spindles, which is used for quick positioning and fixing of workpieces.</p>		800017	800, 801, 802	0,065 kg	1	60,00 EUR

Optional extensions > Accessories > Hydraulic additional press











9	Ku-STA	Item number	\emptyset	max.		Price
<p>The hydraulic additional press is used to increase the pressure capacity of mechanical extractors for particularly tight-fitting bearings, gearwheels and pulleys. With the aid of the hydraulic additional press, extraction forces of up to 30 t can be achieved</p>		9-1	37 mm	10 t	1	276,20 EUR
		9-2	50 mm	15 t	1	343,00 EUR
		9-3	80 mm	30 t	1	833,20 EUR
9-ERS	Ku-STA	Item number				Price
<p>The wearing parts kits for hydraulic auxiliary presses are used to replace worn parts of the hydraulic auxiliary presses of series 9.</p>		9-1-ERS	9-1	0,285 kg	1	200,00 EUR
		9-2-ERS	9-2, K-20-15	0,505 kg	1	320,00 EUR
		9-3-ERS	9-3	0,505 kg	1	0,00
818-0	Ku-STA	Item number				Price
<p>The puller with hydraulic spindle is used for universal application with the pullers of the 818 series. This puller is the basic element of a system which, in conjunction with various accessories, allows universal application possibilities.</p>		818-0	85 mm - 270 mm	280 mm	1	763,80 EUR

818-100	Ku-STA	Item number				Price
<p>The hydraulic bearing puller set is used to pull off ball bearings, roller bearings, inner rings and other flush-fitting parts when there is not enough space for pullers. As a set of the 800 series, it enables a wide range of hydraulic extraction options.</p>		818-100	800-050, 800-100, 800-150, 800, Y-215-2, 818-250, 818-820, 818-279	14,99 kg	1	1.374,20 EUR
818-021	Ku-STA	Item number				Price
<p>The internal extractors from the 818-021 series are used with an extractor with hydraulic spindle from the 818-0 series for extracting internal bearings, bearing outer rings and bushes. Combined with the extractor, the internal extractors are ready for use and can be utilised in a variety of ways.</p>		818-021	135 mm	818-0	1	638,60 EUR
818-215	Ku-STA	Item number				Price
<p>The hydraulic bearing extraction and extraction set is used for extracting and internally extracting ball bearings, roller bearings, inner rings and other flush-fitting parts when there is not enough space for extraction hooks. As a set of the 800 series, it allows high modularity.</p>		818-215	818-021, 818-0, 820-0, Y-215-2, Y-215-3	27,12 kg	1	2.691,20 EUR
818-100	Ku-STA	Item number				Price
<p>The hydraulic bearing puller set is used to pull off ball bearings, roller bearings, inner rings and other flush-fitting parts when there is not enough space for pullers. As a set of the 800 series, it enables a wide range of hydraulic extraction options.</p>		818-100	800-050, 800-100, 800-150, 800, Y-215-2, 818-250, 818-820, 818-279	14,99 kg	1	1.374,20 EUR
818-150	Ku-STA	Item number				Price
<p>The hydraulic bearing puller set is used to pull off ball bearings, roller bearings, inner rings and other flush-fitting parts when there is not enough space for pullers. As a set of the 800 series, it enables a wide range of hydraulic extraction options.</p>		818-150	818-0, Y-215-3	19,39 kg	1	1.483,00 EUR
818-215	Ku-STA	Item number				Price
<p>The hydraulic bearing extraction and extraction set is used for extracting and internally extracting ball bearings, roller bearings, inner rings and other flush-fitting parts when there is not enough space for extraction hooks. As a set of the 800 series, it allows high modularity.</p>		818-215	818-021, 818-0, 820-0, Y-215-2, Y-215-3	27,12 kg	1	2.691,20 EUR



Optional extensions > Accessories > Tie rods and extensions





















818	Ku-STA	Item number	L			Price
<p>The draw bolt extension is used to extend the draw bolts of a puller during separation pull-off.</p> 	818-250	250 mm	818-0	1	51,60 EUR	
	818-280	250 mm	818-0	1	133,60 EUR	
818-P	KU-STA	Item number	L			Price
<p>The pull pin extensions are used to extend the pull pins of a puller during separation pull-off.</p> 	818-250-P	250 mm	818-0	1	126,00 EUR	
	818-280-P	250 mm	818-0	1	210,00 EUR	
818-279	KU-STA	Item number				Price
<p>The tension bolts are spare parts for ball bearing extraction sets "Universal" of series 69. The tension bolts ensure an even pull of the inner and outer bearing ring.</p> 	818-279	69-C, 818-100, 818-150, 818-215	0,965 kg	1	120,00 EUR	
818-T	KU-STA	Item number				Price
<p>The crosshead is a spare part for pullers with hydraulic spindle of series 818-0 or 2-arm pullers with short hydraulic spindle of series 820.</p> 	818-820	818-0, 818-100, 818-150, 818-215, 820-0, 845-855	3,7 kg	1	520,00 EUR	

Pulling > External > Handy pullers with power-transmitting, self-centring puller legs and grease-hydraulic spindle

820	Ku-STA	Item number	 min. - max.	 max.		Price
<p>The 2-arm puller with grease-hydraulic spindle is used to safely pull off particularly tight bearings, gears and discs. The grease-hydraulic spindle of the 800 series is the motor of the extractor and achieves a tractive force of 10 t. As a true miracle of strength, the spindle impresses with its compact design, ease of use and transportability</p>		820-0	85 mm - 225 mm	225 mm	1	778,80 EUR
<p>The hydraulic bearing extraction and extraction set is used for extracting and internally extracting ball bearings, roller bearings, inner rings and other flush-fitting parts when there is not enough space for extraction hooks. As a set of the 800 series, it allows high modularity.</p>		818-215	818-021, 818-0, 820-0, Y-215-2, Y-215-3	27,12 kg		2.691,20 EUR
<p>The pair of extractors is suitable for 2-arm extractors with short hydraulic spindle of the 820 series. The robust extractors guarantee particularly safe extraction of bearings, gears and pulleys.</p>		820-225-P				320,00 EUR

Optional extensions > Accessories > Spare parts for 844/845

844-845	Ku-STA	Item number				Price		
<p>The spare parts for assembly 844/845 are crossbars, threaded bush and various trigger hooks, which are used together with the extractors of series 844 and 845.</p> 		844-000	0,83 kg	844-1-B, 844-2-B, 844-3-B, 844-4-B, 844-5-B	1	97,40 EUR		
		845-004	0,85 kg	845-1-B, 845-2-B, 845-3-B, 845-4-B, 845-5-B, 13-HP-100	1	142,20 EUR		
		844-020	0,3 kg	844-1-B, 844-2-B, 844-3-B, 844-4-B, 844-5-B, 845-1-B, 845-2-B, 845-3-B, 845-4-B, 845-5-B	1	45,20 EUR		
		844-100	0,445 kg	844-1-B, 845-1-B	1	84,00 EUR		
		844-150	0,65 kg	845-2-B, 844-2-B	1	120,00 EUR		
		844-200	0,92 kg	844-4-B, 845-4-B	1	120,00 EUR		
		844-250	0,965 kg	845-3-B, 844-3-B	1	120,00 EUR		
		844-251	1,08 kg	844-5-B, 845-5-B	1	160,00 EUR		
		<p>844-B</p> <p>Ku-STA</p> <p>The handy, 2-arm puller with power-transmitting, self-centring puller legs and grease-hydraulic spindle is used to pull particularly tight bearings, gears and discs. The spindle is characterised by its compact design and ease of use.</p> 		Item number				Price
				844-1-B	26 mm - 100 mm	100 mm	1	445,60 EUR
844-2-B	51 mm - 150 mm			150 mm	1	465,60 EUR		
844-3-B	39 mm - 150 mm			250 mm	1	512,80 EUR		
844-4-B	64 mm - 200 mm			200 mm	1	502,60 EUR		
844-5-B	96 mm - 250 mm			250 mm	1	557,80 EUR		
<p>845-150</p> <p>Ku-STA</p> <p>The hydraulic "4 puller" set with self-centring puller hooks is used for pulling off bearings, gears, washers etc. The easily exchangeable, multi-combinable individual parts in the set can be combined to form four different pullers.</p> 		Item number				Price		
		845-150	844-1-B, 844-2-B, 845-1-B, 845-2-B	9,66 kg	1	997,60 EUR		

844-626	Ku-STA	Item number				Price
<p>The mechanical spindle enables easy and controlled removal of particularly tight parts by impact. In addition, the spindle guarantees particularly good sliding properties in the thread. The fine thread ensures ideal power transmission.</p>		844-626	1.1/2"-16	845-000, 844-000, 820-0, 818-0	1	158,40 EUR
845-B	Ku-STA	Item number	 min. - max.	 max.		Price
<p>The handy, 3-arm puller with power-transmitting, self-centring puller legs and grease-hydraulic spindle is used to pull particularly tight bearings, gears and discs. The spindle is characterised by its compact design and ease of use.</p>		845-1-B	26 mm - 100 mm	100 mm	1	541,80 EUR
		845-2-B	75 mm - 150 mm	150 mm	1	580,40 EUR
		845-3-B	39 mm - 150 mm	250 mm	1	600,20 EUR
		845-4-B	64 mm - 200 mm	200 mm	1	619,00 EUR
		845-5-B	96 mm - 250 mm	250 mm	1	639,60 EUR
845-150	Ku-STA	Item number				Price
<p>The hydraulic "4 puller" set with self-centring puller hooks is used for pulling off bearings, gears, washers etc. The easily exchangeable, multi-combinable individual parts in the set can be combined to form four different pullers.</p>		845-150	844-1-B, 844-2-B, 845-1-B, 845-2-B	9,66 kg	1	997,60 EUR
845-150	Ku-STA	Item number				Price
<p>The hydraulic "4 puller" set with self-centring puller hooks is used for pulling off bearings, gears, washers etc. The easily exchangeable, multi-combinable individual parts in the set can be combined to form four different pullers.</p>		845-150	844-1-B, 844-2-B, 845-1-B, 845-2-B	9,66 kg	1	997,60 EUR
845-250	Ku-STA	Item number				Price
<p>The hydraulic "6 puller" set with self-centring puller hooks is used for pulling off bearings, gears, discs, etc. The easily exchangeable, multi-combinable individual parts in the set can be combined to form six different pullers.</p>		845-250	844-3-B, 844-4-B, 844-5-B, 845-3-B, 845-4-B	15,57 kg	1	1.442,20 EUR

845-851	Ku-STA	Item number				Price
<p>The hydraulic "10 puller" set with self-centring puller hooks is used for pulling off bearings, gears, washers etc. The easily exchangeable, multi-combinable individual parts in the set can be combined to form ten different pullers.</p>		845-851	844-1-B, 844-2-B, 844-3-B, 844-4-B, 844-5-B, 845-1-B, 845-2-B, 845-3-B, 845-4-B, 845-5-B	19,72 kg	1	2.004,20 EUR
		845-855	818-0, 844-1-B, 844-2-B, 844-3-B, 844-4-B, 844-5-B, 845-2-B, Y-215-3	37 kg	1	3.581,40 EUR
<p>The hydraulic universal puller set with separator and self-centring puller hooks is used for pulling off and separating bearings, gears, washers etc. As a set of the 800 series, it enables a wide range of hydraulic extraction options while maintaining modularity.</p>		845-858	818-021, 844-1-B, 844-2-B, 844-3-B, 844-4-B, 844-5-B, 845-2-B, Y-215-3	37 kg	1	4.062,20 EUR
		845-858	818-021, 844-1-B, 844-2-B, 844-3-B, 844-4-B, 844-5-B, 845-2-B, Y-215-3	37 kg	1	4.062,20 EUR

Pressing / Inserting > Pressing / Inserting > Pressing out and pressing in

880	KU-STA	Item number		max.		Price
<p>The universal press frames for silent bushings are used to change bearings on front and rear axles without removing the axle, e.g. for silent bearings, hydromounts, plastic bearings, support joints or shock absorber rubber. They are available in various designs for varying load requirements.</p>		880-800	200 mm	10	1	744,80 EUR
		880-801	200 mm	15	1	937,60 EUR
		880-802	200 mm	20	1	1.095,60 EUR

890	Ku-STA	Item number				Price
<p>The EVOBUS suspension joint removal/retraction tool kit is used for mounting and dismounting the wishbone on ZF axles. The tools can be used on RL 75 E and RL 75 EC axles.</p> 		890-EVO1	265 mm	12,69 kg	1	3.106,00 EUR

Cutting / loosening > Cutting / loosening > Thread files







97	Ku-STA	Item number	für for			Price
<p>The handy thread file is used for manual reworking and cleaning of damaged internal and external threads on technical components such as screws, bolts, axles or shafts. The file is also used for repairing external threads where dies cannot be used.</p> 		97-1	DIN ISO Metrisch	0,125 kg	1	150,00 EUR
		97-2	Whitworth + BSF	0,14 kg	1	150,00 EUR
		97-3	SAE UNF; UNC	0,13 kg	1	150,00 EUR
		97-4	Whitworth Rohrgewin de GAZ; BSPP	0,13 kg	1	150,00 EUR

K-55-B	Ku-STA	Item number				Price
<p>The 7-piece mechanical nut blaster set is used to blast stuck, rusted or over-tightened grade 6 nuts. The two sharp cutting edges of the chisel penetrate deep into the nut when the spindle is tightened until it is blasted.</p> 		K-55-B	97-1, 55-1, 55-2, 55-3	2,015 kg	1	511,70 EUR

W-714	KU-HYD	Item number				Price
<p>The thread renewers are used to repair damaged threads. The thread rebuilders are able to reliably restore threads even on special parts that would otherwise be significantly more expensive to purchase new.</p> 		W-714-1 NEW	160 mm	0 kg	1	546,00 EUR
		W-714-2 NEW	260 mm	0 kg	1	588,00 EUR
		W-714-3 NEW	355 mm	1,8 kg	1	657,80 EUR
		W-714-4 NEW	406 mm	1,515 kg	1	0,00

971	TU_SCH	Item number	schneidend cutting hand			Price
<p>The figure shears in the light version are used for curved cuts as well as short and straight cuts. The built-in opening spring guarantees easy handling and operation. Thanks to the optimised design and geometry of the scissors, even hard-to-reach places can be reached.</p> 		971-240	rechts	243 mm	6	40,00 EUR
		971-241	links	243 mm	6	40,00 EUR
		971-242	links	250 mm	6	40,00 EUR









972	TU_SCH	Item number	schneidend cutting hand	L ←→		Price
<p>The heavy-duty version of the figure shears is used for curved cuts as well as short and straight cuts. The built-in opening spring guarantees easy handling and operation. Thanks to the optimised design and geometry of the shears, even hard-to-reach places can be reached.</p>		972-260	rechts	260 mm	5	80,20 EUR
		972-261	links	260 mm	5	80,20 EUR
973	TU_SCH	Item number	schneidend cutting hand	L ←→		Price
<p>The Ideal shears in the light version are used for straight and continuous cuts as well as figure cuts on sheets that are difficult to cut. Thanks to the optimised design and geometry of the shears, even hard-to-reach places can be reached.</p>		973-241	links	235 mm	6	60,40 EUR
974	TU_SCH	Item number	schneidend cutting hand	L ←→		Price
<p>The heavy-duty version of the Ideal shears is used for straight and continuous cuts as well as figure cuts on sheets that are difficult to cut. Thanks to the optimised design and geometry of the shears, even hard-to-reach places can be reached.</p>		974-260	rechts	260 mm	5	93,60 EUR
		974-261	links	260 mm	5	93,60 EUR
974-HS	TU_SCH	Item number	schneidend cutting hand	L ←→		Price
<p>The Ideal shears are used for straight and continuous cuts as well as figure cuts on sheets that are difficult to cut. The shear head is TiN-coated and ensures an even longer service life. The cutting edges are made of high-speed steel, which increases the cutting speed.</p>		974-HSL	links	260 mm	1	339,00 EUR
		974-HSR	rechts	260 mm	1	339,00 EUR
980	TU_SCH	Item number	schneidend cutting hand	L ←→		Price
<p>The Berlin plate shears are used for long and straight cuts for chipless cutting of sheet metal. Thanks to the blue protective coating, the legs have a particularly good grip. The fixed stop protects the cutting edges and prevents possible injury from crushing.</p>		980-250	rechts	250 mm	5	33,32 EUR
		980-275	rechts	275 mm	5	38,92 EUR
		980-300	rechts	300 mm	5	42,70 EUR
981	TU_SCH	Item number	schneidend cutting hand	L ←→		Price
<p>The Pelikan continuous shears are used for long, straight as well as continuous cuts for chipless cutting of sheet metal. Due to the special design, the shears are particularly suitable for cutting through sheet metal. Thanks to the protective coating, the legs have a particularly good grip.</p>		981-300	rechts	300 mm	5	67,34 EUR









982	TU_SCH	Item number	schneidend cutting hand	L		Price
<p>The perforated plate shears are used for short and straight cuts as well as figure cuts for chipless cutting of sheet metal. Thanks to the protective coating, the legs have a particularly good grip. The fixed stop protects the cutting edges and prevents possible injury from crushing.</p> 		982-250	rechts	250 mm	5	40,88 EUR
		982-251	links	250 mm	5	40,88 EUR
		982-275	rechts	275 mm	5	45,36 EUR
		982-276	links	275 mm	5	70,56 EUR
		982-300	rechts	300 mm	5	48,30 EUR
		982-301	links	300 mm	5	48,30 EUR
983	TU_SCH	Item number	schneidend cutting hand	L		Price
<p>The Ideal shears are used for straight and tapered cuts as well as figure cuts of sheet metal. Thanks to the protective coating, the legs have a particularly good grip. The fixed stop protects the cutting edges and prevents possible injury from crushing.</p> 		983-260	rechts	260 mm	5	77,28 EUR
		983-261	links	260 mm	5	77,56 EUR
		983-280	rechts	280 mm	5	84,84 EUR
		983-281	links	280 mm	5	84,84 EUR
986	TU_SCH	Item number	schneidend cutting hand	L		Price
<p>The goldsmith's/sheet metal shears are used for cutting thin sheets. Thanks to the protective coating, the legs have a particularly good grip. The slim design of the legs makes it possible to work even in places that are difficult to access.</p> 		986-180	rechts	180 mm	12	24,36 EUR
		986-181	links	180 mm	12	28,00 EUR
987	TU_SCH	Item number	schneidend cutting hand	L		Price
<p>The goldsmith's/sheet metal shears are used for cutting thin sheets. Thanks to the protective coating, the legs have a particularly good grip. The slim design of the legs makes it possible to work even in places that are difficult to access.</p> 		987-180	rechts	180 mm	12	24,36 EUR
		987-181	links	180 mm	12	28,00 EUR
988	TU_SCH	Item number	schneidend cutting hand	L		Price
<p>The goldsmith's/sheet metal shears are used for cutting thin sheets. Thanks to the protective coating, the legs have a particularly good grip. The slim design of the legs makes it possible to work even in places that are difficult to access.</p> 		988-180	rechts	180 mm	12	24,36 EUR
		988-181	links	180 mm	12	28,00 EUR
993	TU_SCH	Item number	schneidend cutting hand	L		Price
<p>The universal/combined shears are used for cutting a wide variety of materials for industry and crafts. The scissors cut e.g. sheet metal, wire, plastic, rubber, leather, cardboard and paper. This makes them a real all-rounder among cutting tools.</p> 		993-140	rechts	140 mm	1	30,40 EUR
		993-190	rechts	190 mm	1	33,20 EUR
995	TU_SCH	Item number	schneidend cutting hand	L		Price
<p>The work scissors are used for cutting strong paper, cardboard, thin rubber, leather as well as textiles and are therefore universally applicable. They have a long and a round handle eye, which guarantees optimal guidance.</p> 		995-175	rechts	250 mm	1	24,92 EUR
		995-200	rechts	175 mm	1	28,98 EUR
		995-225	rechts	225 mm	1	32,34 EUR
		995-250	rechts	200 mm	1	44,94 EUR

996	TU_SCH	Item number	schneidend cutting hand	L ←→		Price
<p>The multi-purpose scissors can be used individually and are used for cutting paper and fabrics. They have one long and one round handle eye, which guarantees optimal guidance. The handles made of impact-resistant plastic are adjustable and screwed.</p>		996-180	rechts	180 mm	1	19,60 EUR
		996-210	rechts	210 mm	1	30,38 EUR
997	TU_SCH	Item number	schneidend cutting hand	L ←→		Price
<p>The wick trimmer is used to cut burnt wicks to the desired length. The glowing wick remains on the cutting edge without contaminating the candle. The wick trimmer has two round handle eyes that guarantee optimal guidance.</p>		997-150		150 mm	1	25,90 EUR

Optional extensions > Accessories > Clamp carriage

999	KU-STA	Item number				Price
<p>The 999 series clamp trolley is a sales trolley equipped with clamps for use, storage or sale in the workshop, industry and trade. The large clamp trolley offers plenty of space and an orderly display.</p>		999-000	32 kg	Dark blue	1	1.273,00 EUR

VM	KU-STA	Item number				Price	
<p>The connecting nuts can be used as spacers or as connecting pieces of threaded rods. They are available in both connecting and reducing versions.</p> 		VM10-10	18-0-AS, 18-003A, 18-004A, 18-005A, 18-006A, 18-008A, 18-010A, 18-012A, 18-016A	0,025 kg	1	24,00 EUR	
		VM2015-58	K-226-4/1 2, 226-4/11	0,575 kg	1	60,00 EUR	
		VM1815-58	K-226-4/1 2, 226-4/11	0,6 kg	1	60,00 EUR	
		VM1815-1815	18-3-AS, 18-314A, 18-316A, 18-318A, 18-320A, 18-322A, 18-324A	0,155 kg	1	60,00 EUR	
		VM1615-12		0,3 kg	1	64,68 EUR	
		VM1415-1415	18-2-AS, 18-208A, 18-210A, 18-212A, 18-214A, 18-216A, 18-218A	0,085 kg	1	24,00 EUR	
		VM14-12		0,25 kg	1	0,00	
		VM12-7	KS-22-01, KS-22-02	0,07 kg	1	24,00 EUR	
		VM12-1516	KS-22-01, 22-0-10, KS-22-02	0,1 kg	1	24,00 EUR	
		VM12-10	KS-22-01, KS-22-02, 223, 223-K	0,06 kg	1	21,00 EUR	
		VM112-12	21-89	0,205 kg	1	24,00 EUR	
		VM10-12		0,235 kg	1	0,00	
		VM2215-58	K-226-4/1 2, 226-4/11	0,555 kg	1	60,00 EUR	
	VM34-34	KU-STA	Item number				Price
	<p>The connecting nut for threaded inserts is a spare part used to secure and fasten the adapter.</p> 		VM34-34	21-90	0,34 kg	1	60,00 EUR



GA	KU-STA	Item number				Price
<p>Thread adapters are spare parts that allow flexible connections between different threads and thus provide more flexible application possibilities.</p> 		GA7-10		0,02 kg	1	25,20 EUR
		GA10-1516	22-0-10	0,025 kg	1	25,20 EUR
		GA12-1/2		0,055 kg	1	63,00 EUR
		GA12-1/4		0 kg	1	63,00 EUR
		GA12-10	KS-22-01, KS-22-02	0,055 kg	1	24,00 EUR
		GA12-101	KS-22-02	0,055 kg	1	24,00 EUR
		GA12-121	KS-22-02	0,06 kg	1	24,00 EUR
		GA12-1515	KS-22-02	0,065 kg	1	24,00 EUR
		GA12-1815	223-G	0,155 kg	1	60,00 EUR
		GA12-3	KS-22-01	0,045 kg	1	24,00 EUR
		GA12-3/8		0 kg	1	63,00 EUR
		GA12-4	KS-22-01	0,045 kg	1	24,00 EUR
		GA12-5	KS-22-01	0,05 kg	1	24,00 EUR
		GA12-5/16		0 kg	1	63,00 EUR
		GA12-6	KS-22-01	0,05 kg	1	24,00 EUR
		GA12-7/16		0 kg	1	63,00 EUR
		GA12-8	KS-22-01	0,05 kg	1	24,00 EUR
		GA12-81	KS-22-02	0,05 kg	1	24,00 EUR
		GA1415-12		0,22 kg	1	24,00 EUR
		GA1516-12		0,035 kg	1	23,24 EUR
GA-GS	KU-STA	Item number				Price
<p>The setscrews are spare parts used to secure shafts and gears.</p> 		GA12-8-GS	KS-22-01	0,04 kg	1	40,00 EUR
		GA12-6-GS	KS-22-01	0,025 kg	1	40,00 EUR
		GA12-5-GS	KS-22-01	0,02 kg	1	40,00 EUR
		GA12-4-GS	KS-22-01	0 kg	1	40,00 EUR
		GA12-3-GS	KS-22-01	0,005 kg	1	40,00 EUR
		GA12-10-GS	KS-22-01	0 kg	1	40,00 EUR



GE





KU-STA

The thread inserts are used to produce internal threads for screwed connections. The inserts in different sizes expand the application in handicraft, industry and workshop.







Item number				Price
GE8-1815	223-G	0,095 kg	1	60,00 EUR
GE8-1415	18-2-AS, 18-208A	0,04 kg	1	60,00 EUR
GE8-10	22-1-AS, 223, 223-K, 18-0-AS, 18-008A	0,02 kg	1	24,00 EUR
GE6-10	22-1-AS, 223, 223-K, 18-0-AS, 18-006A	0,025 kg	1	24,00 EUR
GE5-5	K-222-1/7	0,02 kg	1	24,00 EUR
GE5-10	22-1-AS, 223, 223-K, 18-0-AS, 18-005A	0,02 kg	1	24,00 EUR
GE4-10	22-1-AS, 223, 223-K, 18-0-AS, 18-003A, 18-004A	0,02 kg	1	24,00 EUR
GE3-10	223, 223-K, 18-003A	0,02 kg	1	24,00 EUR
GE24-1815	223-G, 18-3-AS, 18-324A	0,21 kg	1	60,00 EUR
GE22-1815	223-G, 18-3-AS, 18-322A	0,19 kg	1	60,00 EUR
GE2015-1615	225	0,15 kg	1	64,68 EUR
GE20-1815	223-G, 18-3-AS, 18-320A	0,16 kg	1	60,00 EUR
GE18-1815	223-G, 18-3-AS, 18-318A	0,14 kg	1	60,00 EUR
GE18-1415	18-2-AS, 18-218A	0,1 kg	1	60,00 EUR
GE18-10	223, 223-K	0,07 kg	1	60,00 EUR
GE162-1615	225	0,085 kg	1	23,24 EUR
GE1615-1615	225	0,1 kg	1	23,24 EUR
GE16-1815	223-G, 18-3-AS, 18-316A	0,14 kg	1	60,00 EUR
GE16-1415	18-2-AS, 18-216A	0,08 kg	1	60,00 EUR
GE16-10	223, 223-K, 18-016A	0,025 kg	1	60,00 EUR
GE142-1615	225	0,085 kg	1	23,24 EUR
GE1415-1615	225	0,1 kg	1	64,68 EUR
GE14-1815	223-G, 18-3-AS, 18-314A	0,11 kg	1	60,00 EUR

GE	KU-STA	Item number				Price
		GE14-1415	18-2-AS, 18-214A	0,07 kg	1	60,00 EUR
		GE14-10	223, 223-K	0,06 kg	1	60,00 EUR
		GE12-1815	223-G	0,12 kg	1	60,00 EUR
		GE12-1415	18-2-AS, 18-212A	0,06 kg	1	60,00 EUR
		GE12-10	22-1-AS, 223, 223- K, 18-0- AS, 18-012A	0,04 kg	1	24,00 EUR
		GE101-1615	225	0,07 kg	1	23,24 EUR
		GE10-1815	223-G	0,105 kg	1	60,00 EUR
		GE10-1415	18-2-AS, 18-210A	0,05 kg	1	60,00 EUR
		GE10-10	22-1-AS, 223, 223- K, 18-0- AS, 18-010A	0,035 kg	1	24,00 EUR
		GE81-1615	225	0,065 kg	1	23,24 EUR

K-Cube-SF	KU-STA	Item number				Price
The drawer with pull-outs and fixing material is a spare part for workshop trolleys of the Cube series.		K-Cube-SF	K- CubeBoxx, K- CubeBoxx -4Set-C	0 kg	1	160,00 EUR

Storage / Presentation > Storage / Presentation > Workshop trolley

K-CubeBoxx	Ku-STA	Item number				Price
The KUKKO-Cube workshop trolley is the smart solution for all transport and storage problems. Equipped with four drawers, the workshop trolley can be individually fitted with Sortimo® L-Boxxes.		K-CubeBoxx	4	43 kg	1	1.155,00 EUR

Optional extensions > Accessories > Empty case

K-L-BOXX	Ku-Sta	Item number				Price
<p>The portable KUKKO empty case from Sortimo offers enough space for an assortment of tools. The case is equipped with special foam that completely embeds the tools. This not only guarantees safe storage, but also makes it possible to stack several layers on top of each other.</p>		K-L-BOXX-L-136	2,66 kg	black-green	1	181,40 EUR
		K-L-BOXX-L-238	3,615 kg	black-grey	1	258,80 EUR
		K-L-BOXX-XL-BOXX	3,2 kg	black-grey	1	344,40 EUR
		K-L+BOXX	4,61 kg	black-green	1	236,00 EUR
		K-i-BOXX	0,985 kg	Green/green	1	54,20 EUR
		K-L-BOXX-MINI	0,385 kg	black-green	1	35,70 EUR
		L-Schloss-45/35	0,08 kg	Green	1	26,00 EUR

Spare parts > Spare parts > Replacement latches for L-Boxx

K-L-Boxx-VS	KU-STA	Item number				Price
		K-L-BOXX-VS	K-L-BOXX-L-136, K-L-BOXX-L-238, K-L+BOXX, K-L-BOXX-XL-BOXX	0,005 kg	2	0,82 EUR
		K-L-BOXX-VSG	K-L-BOXX-L-136, K-L-BOXX-L-238, K-L+BOXX, K-L-BOXX-XL-BOXX	0,005 kg	2	0,82 EUR

Spare parts > Spare parts > Metal case

K15/17-C	KU-STA	Item number				Price
<p>The metal box is a spare part for the disconnecter sets of the 15-C and 17-C series. The simple metal box is used for appropriate storage.</p>		K15/17-C	15-C, 17-C	4,985 kg	1	200,00 EUR
K-A-KT	KU-STA	Item number				Price
<p>The highly impact-resistant polycarbonate lid on a solid base allows safe storage of small parts. The cases can be customised with insert boxes and/or dividers and securely connected by a connecting fastener.</p>		K-A-KT-440-355-76	0 kg	black-green	1	99,60 EUR
		K-A-KT-440-355-144	0 kg	black-green	1	117,60 EUR

K-A-TL	KU-STA	Item number				Price
The KUKKO transport and storage box offers sufficient storage space for tools, various accessories and other workshop supplies.		K-A-TL-600-400-185	0 kg	Green	1	117,60 EUR













Care and safety > Care and safety > Accident protection tarpaulins















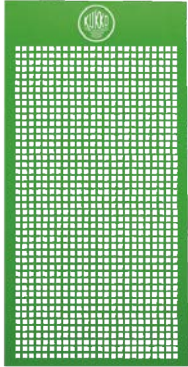

UFP	KU-sta	Item number				Price
The accident protection tarpaulins for pull-off work of the UFP series are required for protection and safeguarding when using large forces. The cover tarpaulins serve to prevent accident hazards and can safely enclose the workpiece and tool even before the forces are applied.		UFP-2	1.500 mm	670 mm	1	439,80 EUR
		UFP-3	4.000 mm	1.300 mm	1	1.517,40 EUR

















Storage / Presentation > Storage / Presentation > Sales walls







EVLW-INDUSTRIE-BASIC	Ku-STA	Item number				Price
The sales wall industry serves the optimal presentation of KUKKO tools in your shop. The illuminated sales wall is equipped with a compilation that has been put together on the basis of many years of experience for use in industry.		EVLW-INDUSTRIE-BASIC	103 mm	225 mm	1	6.239,20 EUR





EVLW-2-INDUSTRIE	Ku-STA	Item number				Price
The sales wall industry serves the optimal presentation of KUKKO tools in your shop. The illuminated sales wall is equipped with a compilation that has been put together on the basis of many years of experience for use in industry.		EVLW-2-INDUSTRIE	103 mm	225 mm	1	11.490,80 EUR

EVLW-2-KFZ	Ku-STA	Item number				Price
<p>The Automotive sales wall is used for the optimal presentation of KUKKO tools in your shop. The illuminated sales wall is equipped with a set that has been put together on the basis of many years of experience for use in the automotive industry.</p>		EVLW-2-KFZ	103 mm	225 mm	1	7.559,00 EUR
<p>The automotive / commercial vehicle / agricultural machinery sales wall is used for the optimum presentation of KUKKO tools in your shop. The illuminated sales wall is equipped with a set that has been put together on the basis of many years of experience for use on commercial vehicles.</p>		EVLW-2-NFZ	103 mm	225 mm	1	9.435,80 EUR
<p>The BASIC puller assortment for industry is a wall panel equipped with matching tools for use and storage. The assortment is suitable for external stripping, internal stripping and separating stripping and is therefore ideal for versatile use in industry.</p>		30-20-T				Price
<p>The BASIC+ puller assortment for industry is a wall panel equipped with matching tools for use and storage. The assortment is suitable for external stripping, internal stripping and separating stripping and is therefore ideal for versatile use in industry.</p>		30-20+T				Price

WT-1-INDUSTRIE	Ku-STA	Item number				Price
<p>The industrial puller assortment is a wall panel equipped with matching tools for use and storage. The assortment is suitable for external stripping, internal stripping and separating stripping and is therefore ideal for versatile use in industry.</p>		WT-1-INDUSTRIE	20-1+, 20-10+, 20-2+, 21-2, 21-3, 21-4, 21-5, 22-0-05, 22-1, 43-1, 43-2, 43-3, 43-11, 43-12, 43-13, 44-1, 45-1, 55-2, WT-000, 15-0, 18-0	21,9 kg	1	2.107,00 EUR
<p>The WT series wall board is used for clean and tidy storage of KUKKO products in industry and workshops. The board can be equipped in many ways and can thus be used ideally for order and overview.</p>		WT-000	 500 mm	 1.000 mm	 1	234,80 EUR
<p>The TOP puller assortment for hydraulic external pulling is a wall panel equipped with suitable tools for use and storage. The assortment can be combined into different outdoor pullers for different applications thanks to the KUKKO modular principle.</p>		WT-002	 20-10+, 20-20+, 1-92-E, WT-000	 16 kg	 1	1.697,20 EUR
<p>The BASIC puller assortment for outdoor stripping is a wall panel equipped with suitable tools for use and storage. The assortment can be combined into different outdoor pullers for different applications thanks to the KUKKO modular principle.</p>		WT-003	 20-10+, 20-20+, 1-92-E, WT-000	 19,65 kg	 1	1.312,00 EUR

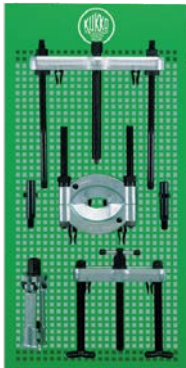
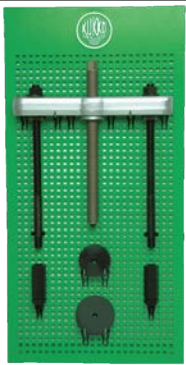

WT-003+S	Ku-STA	Item number				Price
<p>The BASIC+ puller assortment for outdoor stripping is a wall panel equipped with suitable tools for use and storage. The assortment can be combined into different outdoor pullers for different applications thanks to the KUKKO modular principle.</p>		WT-003+S	20-10+S, 20-20+S, WT-000	19,39 kg	1	1.462,60 EUR
WT-004	Ku-STA	Item number				Price
<p>The BASIC puller assortment for automotive is a wall panel equipped with suitable tools for application and storage. The assortment can be combined into different exterior pullers for different applications thanks to the KUKKO modular principle.</p>		WT-004	30-1-T, 20-1+, 1-92-S, 1-92-E, 108-1, 129-1, 135-2, 43-1, 50-2, 55-1, WT-000	9,4 kg	1	1.355,00 EUR
WT-008	Ku-STA	Item number				Price
<p>The BASIC puller assortment for commercial vehicles is a wall panel equipped with suitable tools for use and storage. Especially for commercial vehicles, it includes pullers, a separating device and a long hydraulic spindle to effectively remove parts that are particularly stuck.</p>		WT-008	20-20, 8-0-621, 15-2, 20-20+, 2-300-S, 2-151-S, 2-302-S, 2-153-S, 2-150-E, WT-000	18,1 kg	1	1.895,80 EUR
WT-010	Ku-STA	Item number				Price
<p>The TOP puller assortment for commercial vehicles is a wall panel equipped with suitable tools for use and storage. Included especially for commercial vehicles are a separator and a puller, as well as a short hydraulic spindle, nut splitter and a heavy ball joint extractor.</p>		WT-010	18-2, 20-3+, 800, 56-1, 129-4, 3-203-S, WT-000, 15-2, 8-02	39,5 kg	1	3.243,60 EUR

WT-014	Ku-STA	Item number				Price
<p>The puller assortment for chassis in the automotive is a wall panel equipped with suitable tools for use and storage. In addition to the 2-arm separator "Cobra", the range includes separating forks, as well as spreaders, ball joint extractors and ball joint pullers.</p>		WT-014	210-1, 129-0, 129-0-25, 129-1, 129-4, 128-1, 128-2, 128-3, 135-1, 145-2, 145-3, WT-000	15,3 kg	1	1.636,60 EUR
<p>The BASIC puller assortment for internal extraction is a wall panel equipped with suitable tools for use and storage. The range includes numerous 2-shell and segmented internal extractors, as well as slide hammers and counter supports and two circlip pliers.</p>		WT-017	22-0-05, 22-0-17, 22-1, 22-2, 21-1, 21-2, 21-3, 21-4, 21-5, 21-6, 21-7, 21-8, 21-1-E, 21-2-E, 21-3-E, 21-4-E, 21-5-E, 728K-A2, 729K-J2, WT-000	20,93 kg	1	2.202,80 EUR
<p>The TOP puller assortment for internal extraction is a wall panel equipped with suitable tools for use and storage. Even particularly tight-fitting, interior parts of various sizes can be pulled out safely and in a versatile way thanks to the tools included.</p>		WT-018	43-1, 22-1, 22-2, 21-1, 21-2, 21-3, 21-4, 21-5, 21-6, 21-7, 21-8, 23, WT-000, 20-1+, 20-2+, 9-1	22,735 kg	1	2.257,60 EUR
<p>The separator puller assortment is a wall panel equipped with suitable tools for use and storage. The range includes the 2-arm bearing puller "Cobra" in two different sizes, as well as several separators and pullers.</p>		WT-019	204-0, 17-1, 17-2, 18-1, 18-2, 210-1, WT-000	22,68 kg	1	1.438,40 EUR

WT-020	Ku-STA	Item number				Price
<p>The Premium All-Steel Clamp Assortment is a wall panel equipped with matching tools for use and storage. The range includes various all-steel VIRIDIS screw clamps with 3K comfort grip, as well as all-steel VIRIDIS lever clamps.</p>		WT-020	469+0160-080, 469+0250-100, 469+0250-120, 469+0300-140, 472H0200-100, WT-000	27,7 kg	1	1.035,00 EUR
<p>The Premium Malleable Cast Iron Clamp Assortment is a wall panel equipped with suitable tools for use and storage. The range includes various VIRIDIS malleable cast iron screw clamps with 3K comfort grip, which allows workpieces to be held and clamped gently and securely.</p>		WT-021	490+0160-080, 490+0250-100, 490+0250-120, 490+0300-140, WT-000	0 kg	1	963,00 EUR
<p>The puller assortment for axles in the automotive is a wall panel equipped with suitable tools for use and storage. The assortment includes a puller, separator, internal extractor and counter support in a large version for working on axles.</p>		WT-030	15-3, 18-3, 19-3-P, 22-4, 21-89, WT-000	27,91 kg	1	1.708,60 EUR
<p>The puller assortment for axles at NFZ is a wall panel equipped with suitable tools for use and storage. The range includes an extra-large puller, as well as associated thrust pieces, connecting nuts and threaded inserts.</p>		WT-031	18-4, WT-000, 18-4-B	27,96 kg	1	1.342,00 EUR

WT-50	Ku-STA	Item number				Price
<p>The TOP puller assortment for industry is a wall panel equipped with suitable tools for use and storage. The assortment can be combined into different outdoor pullers for different applications thanks to the KUKKO modular principle.</p> 		WT-50	1-V-150-S, 2-V-150-S, 1-92-E, WT-000, 15-2, 18-2, 20-10+, 20-20+, 9-1	26,44 kg	1	1.950,00 EUR

Optional extensions > Accessories > Inductive storage heaters

T-AW	Ku-HYD	Item number				Price
<p>The inductive bearing warm-up devices of the T-AW series are used for universal application when warming up bearings and other rotationally symmetrical workpieces in crafts, workshops and industry. The bearings can be pulled vertically over the yoke or placed horizontally on the block</p> 		T-AW-20	0-240° C	20,1 kg	1	3.910,80 EUR
		T-AW-40	0-240° C	42 kg	1	6.089,10 EUR
T-AW-20-M	Ku-HYD	Item number				Price
<p>The magnetic sensors are spare parts for inductive bearing heaters of the T-AW series.</p> 		T-AW-40-M	T-AW-40	0,03 kg	1	1.320,00 EUR
		T-AW-20-M	T-AW-20	0,02 kg	1	1.320,00 EUR

Grip / Hold > Grip / Hold > Motor Conductor

Uranos	KU-HYD	Item number				Price
<p>The motor conductor "URANOS" is used for conducting the inclined position when removing and installing motors, gearboxes and batteries of all kinds. By operating the hand chain, the motor conductor can be universally and easily adjusted.</p> 		W-3180	1.900 mm	2.000 kg	1	6.798,00 EUR
		W-3188	1.245 mm	500 kg	1	3.090,00 EUR

Grip / Hold > Grip / Hold > Riveting tools

W-3132/K2	KU-STA	Item number	max			Price
<p>The W-3132 series riveting machine is suitable for all riveting work, especially for brake and clutch linings etc., and even for complicated jaws with longitudinal and vertical ribs. It is a manual tool for riveting and de-riveting with a long lever for energy-saving work.</p> 		W-3132/K2	10 mm	9,395 kg	1	2.221,80 EUR

Testing / measuring > Testing / measuring > Test pumps

W-3209	KU-HYD	Item number				Price
<p>The W-3209 series start of delivery tester is used for testing the start of delivery in diesel engines in trade, industry and workshops. It has a set of connections for M12x1.5 and M14x1.5 threads.</p> 		W-3209		0,28 kg	1	153,20 EUR





Storage / Presentation > Storage / Presentation > Workshop Equipment

X-MW	Ku-STA	Item number				Price
<p>The mobile Workbenches from KUKKO combine the advantages of clear and secure storage with the provision of a multifunctional work surface for everyday needs. The Workbenches have five heavy-duty drawers, an additional storage space with a 9-way adjustable intermediate shelf and fixed door, an interchangeable worktop and a robust rear panel. The perforated grid on the rear panel provides sufficient space for attaching tool holders. A centrally positioned lock closes the drawers and door at the same time.</p> 		X-MW-179-5 NEW	1.590 mm	5	1	5.200,00 EUR













X-SW	Ku-STA	Item number				Price
<p>The stationary Workbenches from KUKKO combine the advantages of clear and secure storage with the provision of a multifunctional work surface for everyday needs. The Workbenches have seven heavy-duty drawers, an additional storage space with a 9-way adjustable intermediate shelf and fixed door, an interchangeable worktop and a robust rear panel. The perforated grid on the rear panel provides sufficient space for attaching tool holders. A centrally positioned lock closes the drawers and door at the same time.</p> 		X-SW-179-6 NEW	1.530 mm	6	1	3.600,00 EUR

X-LS	Ku-STA	Item number				Price
		X-LS-10 NEW	410 mm	10	1	4.440,00 EUR

Care and safety > Care and safety > Tensioning strap











USB	KU-STA	Item number				Price
<p>The lashing strap is used to secure small to medium loads in the transport industry. The clamp buckle has a knurled clamping jaw with a spring mechanism that guarantees a firm hold. If there are hook eyes on the puller, the tensioning strap can be used to better fix and hold the pulling hooks together. This ensures an even safer trigger pull.</p>		USB-1	2.000 mm	25 mm	1	18,00 EUR









Pulling > External > Mobile hydraulic puller "GOLIATH" with adjustable clamping depth











Goliath-200	Ku-HYD	Item number		 max.		Price
<p>The mobile, hydraulic separator "GOLIATH" is used for dismantling large bearings, gears and similar components in heavy industry, railways and power plants as well as other applications. With a pull-off force of up to 50 t, the "GOLIATH" is the solution for really large pull-off operations.</p>		Goliath-200	263 kg	300 mm	1	14.655,90 EUR
		Goliath-300	335 kg	520 mm	1	18.092,40 EUR
		Goliath-500	489 kg	700 mm	1	23.999,40 EUR
Goliath-218	Ku-HYD	Item number		 max.		Price
<p>The mobile, hydraulic separator "GOLIATH" is used for dismantling large bearings, gears and similar components in heavy industry, railways and power plants as well as other applications. With a pull-off force of up to 30 t, the "GOLIATH" is the solution for really large pull-off operations.</p>		Goliath-218	213 kg	300 mm	1	13.370,85 EUR
		Goliath-318	299 kg	520 mm	1	15.279,90 EUR
		Goliath-518	361 kg	520 mm	1	19.516,05 EUR
Goliath	Ku-HYD	Item number	 min. - max.	 max.		Price
<p>The mobile hydraulic puller "GOLIATH" is used to pull off large bearings, gears and similar components. With an extraction force of up to 50 tonnes, the hydraulic puller is the ideal solution for really large extraction processes. The puller can be used with 2 or 3 arms.</p>		Goliath-256	0 mm - 500 mm	300 mm	1	13.242,60 EUR
		Goliath-356	0 mm - 900 mm	520 mm	1	14.768,25 EUR
		Goliath-556	0 mm - 1.200 mm	700 mm	1	18.193,65 EUR

Optional extensions > Accessories > Hydraulic accessories



Y-17	Ku-HYD	Item number	∅	Stück pieces		Price
<p>The thrust piece sets for axle bores are used to pull off bearings and gears in handicrafts, industry and workshops that are mounted on hollow shafts or in housings. The spindle thrust piece serves as a counter-axis to the extractor in that the spindle transmits the force to the thrust piece.</p> 	Y-18-17	20 - 62	12	1	660,30 EUR	
	Y-10-17	49 - 58	1	1	81,60 EUR	
	Y-11-17	51 - 62	1	1	90,00 EUR	
	Y-12-17	55 - 65	1	1	96,45 EUR	
	Y-13-17	58 - 68	1	1	102,00 EUR	
	Y-14-17	61 - 71	1	1	108,90 EUR	
	Y-15-17	65 - 74	1	1	114,30 EUR	
	Y-16-17	71 - 81	1	1	119,70 EUR	
	Y-17-17	77 - 88	1	1	131,85 EUR	
	Y-09-17	45 - 52	1	1	79,05 EUR	
	Y-08-17	42 - 48	1	1	72,45 EUR	
	Y-07-17	39 - 46	1	1	67,05 EUR	
	Y-19-17	33 - 81	12	1	1.044,00 EUR	
	Y-20-17	55 - 88	6	1	671,55 EUR	
	Y-01-17	20 - 23	1	1	30,00 EUR	
	Y-02-17	23 - 26	1	1	36,30 EUR	
	Y-03-17	26 - 30	1	1	43,50 EUR	
	Y-04-17	29 - 33	1	1	49,20 EUR	
	Y-05-17	33 - 39	1	1	54,45 EUR	
	Y-06-17	36 - 42	1	1	61,50 EUR	
Y-60-100-17		6	3	202,35 EUR		

Y-15	Ku-HYD	Item number			Price	
<p>The Y-15 series separating devices are used to pull ball bearings, roller bearings, inner rings and other flush-mounted parts when there is not enough space for Pulling hooks and these must first be separated. They are available in various sizes.</p> 		Y-215-2	22 mm - 115 mm	Y28-180	1	169,35 EUR
		Y-215-3	25 mm - 155 mm	Y28-180	1	276,75 EUR
		Y-315-4	30 mm - 200 mm	Y38-180	1	665,85 EUR
		Y-215-4	30 mm - 200 mm	Y28-180	1	664,80 EUR
		Y-315-5	30 mm - 250 mm	Y38-180	1	1.150,05 EUR
		Y-515-5	30 mm - 250 mm	Y58-180	1	1.206,75 EUR
		Y-515-6	75 mm - 330 mm	Y58-180	1	4.553,40 EUR
		Y-515-7	80 mm - 420 mm	Y58-180	1	5.217,60 EUR
818-100	Ku-HYD	Item number				Price
<p>The hydraulic bearing puller set is used to pull off ball bearings, roller bearings, inner rings and other flush-fitting parts when there is not enough space for pullers. As a set of the 800 series, it enables a wide range of hydraulic extraction options.</p> 		818-100	800-050, 800-100, 800-150, 800, Y-215-2, 818-250, 818-820, 818-279	14,99 kg	1	1.374,20 EUR
Y-21-E	Ku-HYD	Item number			Price	
<p>The Y-21 series internal extractors are used for extracting internal bearings, bearing outer rings and bushes. Depending on the application, there are several variants of the internal extractors. The internal extractors of the Y-21-E series require the extractors of the Y-180 series.</p> 		Y-221-E	135 mm	Y28-180	1	383,70 EUR
		Y-321-E	140 mm	Y38-180	1	691,80 EUR
		Y-521-E	140 mm	Y58-180	1	752,40 EUR



YX8-X00	Ku-HYD	Item number				Price
<p>The Hydraulic Universal Extractor Set is used for extracting, separating and internally extracting particularly large and tightly fitting bearings, gears, discs, etc. The set does not require any further accessories for use and can be used universally due to its composition.</p> 	Y28-200	Y-221-E, YHP-325, Y-215-3, YDB-27E, YRH-202, Y218-06-P, Y218-08-P, Y218-31-P, Y218-33, Y205-20, Y218-10, Y218-11	85 kg	1	6.321,30 EUR	
	Y38-300	YHP-325, Y-315-5, YDB-33E, YRH-302, Y318-36-P, Y318-33, Y318-38-P, Y318-41-P, Y305-20, Y318-10, Y318-11	188 kg	1	9.224,85 EUR	
	Y58-500	Y-521-E, YHP-325, Y-515-6, YDB-55E, YRH-603, Y518-08-P, Y518-31-P, Y518-33, Y505-20, Y518-10, Y518-11	335 kg	1	15.769,50 EUR	
Y-57	Ku-HYD	Item number	 M			Price
<p>The 4-piece, pump-hydraulic nut blaster set is used for blasting undetachably stuck, rusted or overtightened nuts of all grades. The TiN coating of the bit has particularly good friction properties, which results in a high cutting performance.</p> 	Y-57-10	10 mm - 19 mm	2,26 kg	1	1.467,15 EUR	
	Y-57-19	19 mm - 24 mm	3,24 kg	1	1.602,60 EUR	
	Y-57-24	24 mm - 32 mm	5,4 kg	1	1.731,00 EUR	
	Y-57-32	32 mm - 41 mm	8,53 kg	1	1.866,75 EUR	
	Y-57-41	41 mm - 50 mm	13,44 kg	1	2.266,65 EUR	
	Y-57-50	50 mm - 60 mm	25,08 kg	1	2.995,95 EUR	
	Y-57-60	60 mm - 75 mm	34,1 kg	1	5.612,85 EUR	

Y-57-M	Ku-HYD	Item number				Price
<p>The blasting bits are spare parts for pump-hydraulic nut splitters of the Y-57 series. The extremely sharp bits ensure the blasting of irremovably stuck nuts.</p> 		Y-5710M	Y-57-10	0,035 kg	1	0,00
		Y-5719M	Y-57-19	2 kg	1	0,00
		Y-5724M	Y-57-24	0,13 kg	1	520,00 EUR
		Y-5732M	Y-57-32	0,2 kg	1	520,00 EUR
		Y-5741M	Y-57-41	0,385 kg	1	520,00 EUR
		Y-5750M	Y-57-50	0,455 kg	1	520,00 EUR
		Y-5760M	Y-57-60	0 kg	1	760,00 EUR
Y-60-100	Ku-HYD	Item number	max.			Price
<p>The hydraulic wheel hub removal tool for commercial vehicles and low-floor buses is used for safe and quick removal of the wheel hub on commercial vehicles and buses. The perforated disc and the 30 t pressure cylinder are able to loosen very tight and difficult to remove wheel hubs.</p> 		Y-60-100	30 t	37 kg	1	2.616,45 EUR
Y-AP-3XX	KU-HYD	Item number				Price
<p>The accessories for "AXLE" Y-AP-75 are used in conjunction with it to quickly and easily press out and press in lorry kingpins in trade, industry and workshops.</p> 		Y-AP-371	150	Y-AP-75	1	378,75 EUR
		Y-AP-372	150	Y-AP-75	1	576,00 EUR
		Y-AP-373	120	Y-AP-75	1	552,30 EUR













Pressing / Inserting > Pressing / Inserting > Workshop press



Axle	Ku-HYD	Item number	max.			Price
<p>The hydraulic kingpin press is used to quickly press in and press out all common kingpins on commercial vehicle front axles. For positioning, the working unit can be swivelled and adjusted and the flat design allows work even on low-lying vehicles.</p> 		Y-AP-75	75	286 kg	155 mm	9.288,45 EUR



Optional extensions > Accessories > Puller without hollow piston cylinder



Y0-208	Ku-HYD	Item number	 max.	max.		Price
<p>The 3-arm combi pullers with swivelling puller hooks of the Y-208 series are used for pulling off particularly large and tight bearings, gear wheels, discs, etc. The puller is equipped with a hydraulic pressure cylinder with collar thread of the YRE series. A hydraulic pressure cylinder with collar thread of the YRE series is required for use.</p> 		Y05-208	215 mm	4.5 t	1	274,95 EUR
		Y10-208	500 mm	10 t	1	686,10 EUR











Pulling > External > Puller with pump hydraulics and adjustable clamping depth

Y-208	Ku-HYD	Item number	 min. - max.	 max.		Price
<p>The hydraulic, 3-arm puller with adjustable clamping depth, hydraulic pressure cylinder for pump drive and combination crosshead is used to remove particularly large and tight bearings, gears and discs. It can be used to loosen parts that are freely accessible from the outside.</p> 	Ku-HYD	Y08-208	110 mm - 250 mm	215 mm	1	652,80 EUR
		Y18-208	160 mm - 500 mm	500 mm	1	652,80 EUR
Y20-11	Ku-HYD	Item number	 max. mm	max.		Price
<p>The 3-arm pullers with adjustable clamping depth from the Y20-11 series are used to pull particularly large and tight-fitting bearings, gears, discs, etc. They can be used with a hydraulic hollow piston cylinder from the YRH series. A hydraulic hollow piston cylinder from the YRH series is also required for use.</p> 	Ku-HYD	Y20-11-0 NEW	375 mm	20 t	1	1.323,00 EUR
		Y20-11-1 NEW	520 mm	20 t	1	1.711,35 EUR
		Y20-11-2 NEW	650 mm	20 t	1	1.883,40 EUR
Y0-180	Ku-HYD	Item number	 max.	max.		Price
<p>The extractors of the Y-180 series are used together with cut-off knives and internal extractors for extracting particularly large and tight-fitting bearings, gears, discs, etc. They are used with cut-off knives of the Y-15 series and internal extractors of the Y-21-E series. They are used with series Y-15 separators and series Y-21-E internal extractors.</p> 	Ku-HYD	Y20-180	135 mm - 300 mm	15 t	1	769,05 EUR
		Y30-180	180 mm - 420 mm	25 t	1	1.281,75 EUR
		Y50-180	235 mm - 540 mm	35 t	1	3.258,00 EUR
Y0-205	Ku-HYD	Item number	 max.	max.		Price
<p>The 2-arm pullers with swivelling puller hooks of the Y-205 series are used for pulling off particularly large and tight bearings, gear wheels, washers etc. in trade, industry and workshops. A hydraulic hollow piston cylinder of the YRH series is required for use.</p> 	Ku-HYD	Y20-205	300 mm	15 t	1	588,15 EUR
		Y20-215	850 mm	15 t	1	881,40 EUR
		Y30-205	520 mm	25 t	1	1.211,40 EUR
		Y50-205	700 mm	45 t	1	2.272,05 EUR
		Y50-215	1.600 mm	45 t	1	3.407,40 EUR





Y0-206	Ku-HYD	Item number	 max.	max.		Price
<p>The 3-arm pullers with swivelling puller hooks of the Y-206 series are used for pulling off particularly large and tight bearings, gear wheels, discs etc. in trade, industry and workshops. A hydraulic hollow piston cylinder of the YRH series is required for use.</p> 		Y20-206	470 mm	20 t	1	916,65 EUR
		Y30-206	720 mm	30 t	1	1.903,20 EUR
		Y50-206	970 mm	50 t	1	3.544,50 EUR
		Y20-216	850 mm	20 t	1	1.374,30 EUR
		Y50-216	1.600 mm	50 t	1	5.317,35 EUR









Y-X00	Ku-HYD	Item number	für for			Price
<p>The holders for hydraulic cylinders in the Y-X00 series are used to attach tools in the KUKKO hydraulic programme. The holders in various sizes attach heavy equipment to the respective hydraulic device and are suitable for the GOLIATH series, among others.</p> 		Y200-00	YRH-202	Y28-180, Y28-205, Y28-206, Y28-200, Y28-218, Y28-256, Goliath-20 0, Goliath-21 8, Goliath-25 6	1	342,00 EUR
		Y300-00	YRH-202	Y38-180, Y38-205, Y38-206, Y38-300, Y38-318, Y38-356, Goliath-30 0, Goliath-31 8, Goliath-35 6	1	382,95 EUR
		Y500-00	YRH-202	Y58-180, Y58-205, Y58-206, Y58-500, Y58-518, Y58-556, Goliath-50 0, Goliath-51 8, Goliath-55 6	1	408,00 EUR





Y205	Ku-HYD	Item number	L			Price
<p>The puller hook with lugs, bolts and nuts is used for pulling off particularly large and tight-fitting bearings, gears and discs. The multiple holes in the hook ensure individual adjustment to the desired clamping depth</p> 		Y205-00	470 mm	Y28-205, Y28-206	1	195,90 EUR
		Y205-27	600 mm	Y28-205, Y28-206	1	284,25 EUR
		Y305-00	720 mm	Y38-206, Y38-205	1	471,90 EUR
		Y505-00	970 mm	Y58-205, Y58-206	1	1.071,30 EUR
Y205/206	Ku-HYD	Item number	max.			Price
<p>The accessories for hydraulic pullers are needed for use with the pullers from the KUKKO hydraulic programme. The pullers with lugs, bolts and nuts as well as 2-arm or 3-arm traverses are designed for the Y20, Y28, Y30, Y38, Y50 and Y58 series.</p> 		Y205-20	20 t	Y28-205, Y28-206	1	179,85 EUR
		Y206-30	20 t	Y28-205, Y28-206	1	482,25 EUR
		Y305-20	30 t	Y38-205, Y38-206	1	268,65 EUR
		Y306-30	30 t	Y38-205, Y38-206	1	487,65 EUR
		Y505-20	50 t	Y58-205, Y58-206	1	549,60 EUR
		Y506-30	50 t	Y58-205, Y58-206	1	960,30 EUR
Y-18-E	Ku-HYD	Item number	max.			Price
<p>The accessories for hydraulic extractors are needed for use with the extractors from the KUKKO hydraulic programme. The traverses, fastening materials, pull bolts, support nuts, connectors for pull bolts and quick adjustment nuts are designed for the Y series.</p> 		Y218-03	15 t	Y28-180	1	405,00 EUR
		Y318-37-P	25 t	Y38-180	1	372,60 EUR
		Y318-38-P	25 t	Y38-180	1	640,80 EUR
		Y318-39-P	25 t	Y38-180	1	213,60 EUR
		Y318-41-P	25 t	Y38-180	1	102,45 EUR
		Y518-03	35 t	Y58-180	1	1.580,70 EUR
		Y518-07-P	35 t	Y58-180	1	1.046,10 EUR
		Y518-08-P	35 t	Y58-180	1	723,30 EUR
		Y518-09-P	35 t	Y58-180	1	471,45 EUR
		Y518-31-P	35 t	Y58-180	1	276,30 EUR
		Y318-33	25 t	Y38-180	1	148,65 EUR
		Y318-36-P	25 t	Y38-180	1	268,65 EUR
		Y318-04	25 t	Y38-180	1	106,80 EUR
		Y218-04	15 t	Y28-180	1	125,40 EUR
		Y218-06-P	15 t	Y28-180	1	135,15 EUR
		Y218-07-P	15 t	Y28-180	1	173,70 EUR
		Y218-08-P	15 t	Y28-180	1	220,50 EUR
		Y218-09-P	15 t	Y28-180	1	96,45 EUR
		Y218-12-P	15 t	Y28-180	1	115,95 EUR
		Y218-31-P	15 t	Y28-180	1	89,25 EUR
Y218-33	15 t	Y28-180	1	86,40 EUR		
Y318-03	25 t	Y38-180	1	550,95 EUR		
Y518-33	35 t	Y58-180	1	220,50 EUR		





Y-10-11	Ku-HYD	Item number	max.			Price
<p>The accessories for hollow piston cylinders are used with the extractors from the KUKKO hydraulic programme in trade, industry and workshops. The hand cranks and centre spindle are designed for the hollow piston cylinders of the YRH series.</p> 		Y218-10	20 t	1,865 kg	1	36,90 EUR
		Y218-11	20 t	1,69 kg	1	115,65 EUR
		Y318-10	20 t	0,88 kg	1	48,90 EUR
		Y318-11	30 t	3,205 kg	1	405,00 EUR
		Y318-12	30 t	8 kg	1	880,00 EUR
		Y518-10	50 t	2,01 kg	1	74,10 EUR
		Y518-11	50 t	6,745 kg	1	559,35 EUR
Y28-11	Ku-HYD	Item number	 min. - max.	 max.		Price
<p>The hydraulic, extra powerful 3-arm puller with adjustable clamping depth and hydraulic hollow piston cylinder for pump drive is used to remove particularly tight bearings, gears and discs. It can be used to loosen components that are freely accessible from the outside.</p> 		Y28-11-0 NEW	0 mm - 520 mm	300 mm	1	1.601,85 EUR
		Y28-11-1 NEW	0 mm - 520 mm	300 mm	1	2.419,80 EUR
		Y28-11-2 NEW	0 mm - 520 mm	140 mm	1	2.576,70 EUR
Y-180	Ku-HYD	Item number				Price
<p>The hydraulic extractor of the Y-180 series is used for extracting particularly large and tight-fitting bearings, gears, discs, etc. by using separating blades and internal extractors. It is used together with the Y-15 separating device or the Y-21-E internal extractor.</p> 		Y28-180	135 mm - 300 mm	470 mm	1	2.360,40 EUR
		Y38-180	180 mm - 420 mm	520 mm	1	3.605,85 EUR
		Y58-180	235 mm - 540 mm	660 mm	1	7.398,15 EUR

























YX8-X00	Ku-HYD	Item number				Price
<p>The Hydraulic Universal Extractor Set is used for extracting, separating and internally extracting particularly large and tightly fitting bearings, gears, discs, etc. The set does not require any further accessories for use and can be used universally due to its composition.</p> 	Y28-200	Y-221-E, YHP-325, Y-215-3, YDB-27E, YRH-202, Y218-06-P, Y218-08-P, Y218-31-P, Y218-33, Y205-20, Y218-10, Y218-11	85 kg	1	6.321,30 EUR	
	Y38-300	YHP-325, Y-315-5, YDB-33E, YRH-302, Y318-36-P, Y318-33, Y318-38-P, Y318-41-P, Y305-20, Y318-10, Y318-11	188 kg	1	9.224,85 EUR	
	Y58-500	Y-521-E, YHP-325, Y-515-6, YDB-55E, YRH-603, Y518-08-P, Y518-31-P, Y518-33, Y505-20, Y518-10, Y518-11	335 kg	1	15.769,50 EUR	









YX8-X00	Ku-HYD	Item number				Price
<p>The Hydraulic Universal Extractor Set is used for extracting, separating and internally extracting particularly large and tightly fitting bearings, gears, discs, etc. The set does not require any further accessories for use and can be used universally due to its composition.</p>		Y28-200	Y-221-E, YHP-325, Y-215-3, YDB-27E, YRH-202, Y218-06-P, Y218-08-P, Y218-31-P, Y218-33, Y205-20, Y218-10, Y218-11	85 kg	1	6.321,30 EUR
		Y38-300	YHP-325, Y-315-5, YDB-33E, YRH-302, Y318-36-P, Y318-33, Y318-38-P, Y318-41-P, Y305-20, Y318-10, Y318-11	188 kg	1	9.224,85 EUR
		Y58-500	Y-521-E, YHP-325, Y-515-6, YDB-55E, YRH-603, Y518-08-P, Y518-31-P, Y518-33, Y505-20, Y518-10, Y518-11	335 kg	1	15.769,50 EUR
Y-205	Ku-HYD	Item number				Price
<p>The hydraulic, 2-arm puller with adjustable clamping depth and hydraulic hollow piston cylinder for pump drive is used to remove particularly large and tight bearings, gears and discs. It can be used to loosen components on shafts that are freely accessible from the outside.</p>		Y28-205	280 mm - 420 mm	300 mm	1	1.602,45 EUR
		Y28-215	280 mm - 420 mm	600 mm	1	2.115,90 EUR
		Y38-205	330 mm - 700 mm	520 mm	1	2.755,05 EUR
		Y58-205	460 mm - 1.000 mm	700 mm	1	5.574,60 EUR
		Y58-215	460 mm - 1.000 mm	1.200 mm	1	8.171,40 EUR

Y-206	Ku-HYD	Item number	 min. - max.			Price
<p>The hydraulic, 2- and 3-arm puller with adjustable clamping depth and hydraulic hollow piston cylinder for pump drive is used to remove particularly large and tight bearings, gears and discs. It can be used to loosen parts that are freely accessible from the outside.</p> 	Y28-206	280 mm - 500 mm	300 mm	1	2.172,90 EUR	
	Y38-206	330 mm - 900 mm	520 mm	1	3.698,25 EUR	
	Y58-206	460 mm - 1.200 mm	700 mm	1	7.124,10 EUR	
	Y28-216	280 mm - 420 mm	600 mm	1	3.298,65 EUR	
	Y58-216	460 mm - 1.200 mm	1.200 mm	1	12.761,25 EUR	

YX8-X56	Ku-HYD	Item number				Price
<p>The hydraulic external extractor sets are used for extracting particularly large and tight bearings, gear wheels, discs, etc. The set does not require any further accessories and can be used universally due to its composition. The set does not require any further accessories for use and can be used universally due to its composition.</p> 	Y28-256	YHP-325, YRH-202, Y205-20, Y218-10, Y218-11	68 kg	1	3.430,95 EUR	
	Y38-356	YHP-325, YRH-302, Y305-20, Y318-10, Y318-11	93,42 kg	1	5.334,90 EUR	
	Y58-556	YHP-325, YRH-603, Y505-20, Y518-10, Y518-11	175 kg	1	8.991,45 EUR	

YX8-X18	Ku-HYD	Item number				Price
<p>The hydraulic extractor sets are used for separating and internally extracting particularly large and tightly fitting bearings, gears, discs, etc. The set does not require any further accessories for use and can be used universally due to its composition.</p> 	Y28-218	Y-221-E, YHP-325, Y-215-3, YDB-27E, YRH-202, Y218-06-P, Y218-08-P, Y218-31-P, Y218-33, Y218-10, Y218-11	60 kg	1	4.298,25 EUR	
	Y38-318	YHP-325, Y-315-5, YDB-33E, YRH-302, Y318-36-P, Y318-33, Y318-38-P, Y318-41-P, Y318-10, Y318-11	115 kg	1	7.087,65 EUR	
	Y58-518	Y-521-E, YHP-325, Y-515-6, YDB-55E, YRH-603, Y518-08-P, Y518-31-P, Y518-33, Y518-10, Y518-11	220 kg	1	11.467,80 EUR	
YX8-X56	Ku-HYD	Item number				Price
<p>The hydraulic external extractor sets are used for extracting particularly large and tight bearings, gear wheels, discs, etc. The set does not require any further accessories and can be used universally due to its composition. The set does not require any further accessories for use and can be used universally due to its composition.</p> 	Y28-256	YHP-325, YRH-202, Y205-20, Y218-10, Y218-11	68 kg	1	3.430,95 EUR	
	Y38-356	YHP-325, YRH-302, Y305-20, Y318-10, Y318-11	93,42 kg	1	5.334,90 EUR	
	Y58-556	YHP-325, YRH-603, Y505-20, Y518-10, Y518-11	175 kg	1	8.991,45 EUR	

Y518-04	Ku-HYD	Item number				Price
The set of fastening material is a spare part for hydraulic extractors.		Y518-04	Y58-180	0 kg	1	200,00 EUR
YC	Ku-HYD	Item number				Price
The quick coupling of the YC series is used together with the hydraulic cylinders of the YRH and YRE series. The complete coupling consists of the coupling plug (YCH-604) and the coupling sleeve (YCR-400) with protective cap.		YCR-400	700 bar	AG: 3/8" - IG:	1	135,45 EUR
		YCH-604	700 bar	IG: CR-400	1	90,00 EUR
YD	Ku-HYD	Item number	max.			Price
The thrust pieces for hollow piston cylinders are screwed into the internal thread of the piston rod of hollow piston cylinders. The centre spindle can be inserted directly into the threaded piece or, if a thrust piece with a smooth bore is used, it can be fastened by means of a quick-set nut.		YDB-33E	30 t	0,21 kg	1	78,15 EUR
		YDB-55E	50 t	0,5 kg	1	96,90 EUR
		YDG-20E	20 t	0,18 kg	1	80,10 EUR
		YDG-30E	30 t	0,285 kg	1	117,60 EUR
		YDG-50E	50 t	0,85 kg	1	245,85 EUR
		YDM-20E	20 t	0,28 kg	1	81,60 EUR
		YDM-30E	30 t	0,38 kg	1	87,90 EUR
		YDM-50E	50 t	1,06 kg	1	135,90 EUR
		YDB-27E	20 t	0,17 kg	1	75,90 EUR
YHP	Ku-HYD	Item number				Price
The hydraulic hand pump, pressure gauge and hose are needed for use with extractors from the KUKKO hydraulic range. The range includes high-pressure hydraulic hand pumps, pressure gauges, hoses and various connections and adapters available in different combinations.		YHP-320	700 bar	0.0007 m ³	1	320,40 EUR
		YHP-321	700 bar	0.0009 m ³	1	522,15 EUR
		YHP-324	700 bar	0.0009 m ³	1	583,80 EUR
		YHP-325	700 bar	0.0009 m ³	1	785,70 EUR
		YHP-326	700 bar	0.0009 m ³	1	927,60 EUR
		YHP-420	700 bar	0.002 m ³	1	352,20 EUR
		YHP-421	700 bar	0.002 m ³	1	493,65 EUR
		YHP-424	700 bar	0.002 m ³	1	478,50 EUR
		YHP-425	700 bar	0.002 m ³	1	631,95 EUR
		YF-200	700 bar		1	258,00 EUR
		YM-235	700 bar		1	337,05 EUR
		YGA-2			1	105,60 EUR

YX8-X18	Ku-HYD	Item number				Price
<p>The hydraulic extractor sets are used for separating and internally extracting particularly large and tightly fitting bearings, gears, discs, etc. The set does not require any further accessories for use and can be used universally due to its composition.</p> 		Y28-218	Y-221-E, YHP-325, Y-215-3, YDB-27E, YRH-202, Y218-06-P, Y218-08-P, Y218-31-P, Y218-33, Y218-10, Y218-11	60 kg	1	4.298,25 EUR
		Y38-318	YHP-325, Y-315-5, YDB-33E, YRH-302, Y318-36-P, Y318-33, Y318-38-P, Y318-41-P, Y318-10, Y318-11	115 kg	1	7.087,65 EUR
		Y58-518	Y-521-E, YHP-325, Y-515-6, YDB-55E, YRH-603, Y518-08-P, Y518-31-P, Y518-33, Y518-10, Y518-11	220 kg	1	11.467,80 EUR
YHP-320-VT	Ku-HYD	Item number				Price
<p>The valve set is a spare part for hydraulic hand pumps of the YHP-320 series.</p> 		YHP-320-VT	YHP-320	0,045 kg	1	520,00 EUR

YHU-XXX	Ku-HYD	Item number	L			Price
<p>The accessories for "AXLE" Y-AP-75 are used together with it to quickly and easily press out and press in kingpins in trade, industry and workshops. The range includes base plate HUB, locking pieces, pressure bolts, clamping claws, U-bolts and mounting kits.</p> 		YHU-S-AP-B10	150	YHU-S-AP-255	1	46,05 EUR
		YHU-S-AP-B11	150	YHU-S-AP-255	1	46,05 EUR
		YHU-S-AP-B12	120	YHU-S-AP-255	1	49,65 EUR
		YHU-S-AP-B13	220	YHU-S-AP-255	1	49,65 EUR
		YHU-S-AP-B14	120	YHU-S-AP-255	1	53,85 EUR
		YHU-S-AP-B15	220	YHU-S-AP-255	1	53,85 EUR
		YHU-S-AP-B16	120	YHU-S-AP-255	1	57,30 EUR
		YHU-S-AP-B17	220	YHU-S-AP-255	1	57,30 EUR
		YHU-S-AP-B1	set of pressure bolts (150 - 220)	YHU-S-AP-255	1	378,75 EUR
		YHU-S-11-1-SP	clamping jaw	YHU-S, YHU-S-Y28-11-1	1	157,05 EUR
		YHU-S-AP-V0	set of locking pieces (61; 45)	YHU-S-AP-255	1	57,30 EUR
		YHU-S-AS	attachment kit	YHU-S-Y28-11-1	1	7,05 EUR
		YHU-S-B-075	U-bolt (75 x 125)	YHU-S, YHU-S-AP-255, YHU-S-Y28-11-1	1	15,45 EUR
		YHU-GP-001	base plate	YHU-S, YHU-S-AP-255, YHU-S-Y28-11-1	1	370,95 EUR

Grip / Hold > Grip / Hold > KUKKO-Rhino

YHU	Ku-HYD	Item number	max.			Price
<p>The RHINO hydraulic transmission jack is used for work on car and truck transmissions, clutches and differentials. The two-axis swivelling base plate with adjustable brackets and chains is used to align the receptacles and tool universal receptacle up to 1.5 t.</p> 		YHU-S	1.5 t	725	1	1.645,65 EUR

Citaro	Ku-HYD	Item number	max.			Price
The "Citaro" hydraulic wheel hub puller is used to pull off wheel hubs. It can be used to perfectly loosen very tight wheel hubs that are difficult to remove. The 30 t pressure cylinder enables a time-saving and universal application, even for stubborn parts.		YHU-S-Citaro	30 t	0 kg	1	4.628,25 EUR

Pulling > External > "DAVID"







David	Ku-HYD	Item number	 min. - max.	 max.		Price
The hydraulic, mobile 3-arm puller with adjustable clamping depth "DAVID" is used for pulling off large bearings, gear wheels and similar components. With a maximum load of 20 t, the puller offers a strong, hydraulic solution for otherwise difficult tasks.		YHU-S-Y28-11-1	0 mm - 520 mm	300 mm - 500 mm	1	4.439,40 EUR

YPP	Ku-HYD	Item number				Price
The pneumatic, hydraulic pumps are needed for use with the extractors from the KUKKO hydraulic programme. The hydraulic pump, which is operated with compressed air, can be used by means of foot or manual operation and is available either individually or together with a hose and pressure gauge.		YPP-520	700 bar	0.003 m³	1	918,60 EUR
		YPP-525	700 bar	0.003 m³	1	1.281,15 EUR

Optional extensions > Accessories > Hydraulic cylinders

YRE	Ku-HYD	Item number	max.			Price
The hydraulic pressure cylinders with collar thread of the YRE series are used with the KUKKO hydraulic programme for use in all positions. The model with a long stroke length enables effortless and versatile work even in difficult pulling situations.		YRE-050	5	125	1	380,25 EUR
		YRE-101	10	250	1	420,45 EUR
		YRE-106	10	155	1	378,30 EUR
		YRE-701	75	155	1	1.894,80 EUR

YRE-050-K	Ku-HYD	Item number				Price
The seal kit is a spare part for hydraulic pressure cylinders with collar thread of the YRE series.		YRE-101-K	YRE-101	0 kg	1	880,00 EUR
		YRE-050-K	YRE-050	0,05 kg	1	760,00 EUR

YRH	Ku-HYD	Item number	max.			Price
<p>The hydraulic hollow piston cylinders of the YRH series are used with the KUKKO hydraulic programme. They can be used both as push and pull cylinders and in this way enable power-saving and versatile working.</p>		YRH-132	13	8	1	519,75 EUR
		YRH-202	20	50	1	864,00 EUR
		YRH-206	20	150	1	1.462,95 EUR
		YRH-302	30	63	1	1.188,15 EUR
		YRH-603	50	75	1	2.537,55 EUR
YSM	KU-HYD	Item number	max.			Price
<p>The YSM series lifting cylinders are used with the KUKKO hydraulic range when other cylinders are too large. They can also be used in confined spaces and enable force-saving and versatile work even in difficult pull-off situations.</p>		YSM-100	10	12	1	432,45 EUR
		YSM-200	20	11	1	553,80 EUR